



**THE DATASHEET OF
SMA3107-TL-E**



Monolithic Microwave Integrated Circuits (MMIC)

**Amplifier, 3 V, 6 mA,
0.1 to 2.8 GHz, MCPH6**

SMA3107

Features

- High Gain : $G_p = 23.5$ dB typ. @1 GHz
- Wideband Response : $f_u = 2.8$ GHz
- Low Current : $I_{CC} = 6$ mA typ
- Port Impedance : Input/Output 50 Ω
- This is a Pb-Free Device

ABSOLUTE MAXIMUM RATINGS ($T_A = 25^\circ\text{C}$ unless otherwise noted)

Symbol	Parameter	Ratings	Unit
V_{CC}	Supply Voltage	5	V
I_{CC}	Circuit Current	15	mA
P_D	Allowable Power Dissipation	280	mW
T_{opr}	Operating Temperature	-40 to +85	$^\circ\text{C}$
T_{STG}	Storage Temperature	-55 to +150	$^\circ\text{C}$

Stresses exceeding those listed in the Maximum Ratings table may damage the device. If any of these limits are exceeded, device functionality should not be assumed, damage may occur and reliability may be affected.

RECOMMENDED OPERATING CONDITION

($T_A = 25^\circ\text{C}$ unless otherwise noted)

Symbol	Parameter	Ratings			Unit
		Min	Typ	Max	
V_{CC}	Supply Voltage	2.7	3	3.3	V
T_{opr}	Operating Ambient Temperature	-40	+25	+85	$^\circ\text{C}$

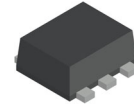

SC-88FL / MCPH6
CASE 419AS

MARKING DIAGRAM

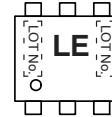

LE = Specific Device Code

ORDERING INFORMATION

Device	Package	Shipping [†]
SMA3107-TL-E	MCPH6 (Pb-Free)	3000 / Tape & Reel

[†]For information on tape and reel specifications, including part orientation and tape sizes, please refer to our Tape and Reel Packaging Specifications Brochure, [BRD8011/D](#).

SMA3107

ELECTRICAL CHARACTERISTICS ($T_A = 25^\circ\text{C}$, $V_{CC} = 3\text{ V}$, $Z_S = Z_L = 50\ \Omega$)

Symbol	Parameter	Conditions	Ratings			Unit
			Min	Typ	Max	
I_{CC}	Circuit Current		4.3	6.0	7.7	mA
G_p	Power Gain	$f = 1\text{ GHz}$	21.0	23.5	26.0	dB
		$f = 2.2\text{ GHz}$	22.0	24.5	27.0	
I_{SL}	Isolation	$f = 1\text{ GHz}$	33.0	38.0	-	dB
		$f = 2.2\text{ GHz}$	40.0	45.0	-	
R_{Lin}	Input Return Loss	$f = 1\text{ GHz}$	18.0	23.0	-	dB
		$f = 2.2\text{ GHz}$	10.0	13.0	-	
R_{Lout}	Output Return Loss	$f = 1\text{ GHz}$	27.0	32.0	-	dB
		$f = 2.2\text{ GHz}$	10.0	13.0	-	
NF	Noise Figure	$f = 1\text{ GHz}$	-	3.1	4.3	dB
		$f = 2.2\text{ GHz}$	-	3.6	4.3	
$P_{O(1dB)}$	Gain 1 dB Compression Output Power	$f = 1\text{ GHz}$	-10	-8	-	dBm
		$f = 2.2\text{ GHz}$	-11.5	-9.5	-	
f_u	Upper Limit Operating Frequency	3 dB down below fl at gain at $f = 1\text{ GHz}$	-	2.8	-	GHz

Product parametric performance is indicated in the Electrical Characteristics for the listed test conditions, unless otherwise noted. Product performance may not be indicated by the Electrical Characteristics if operated under different conditions.

NOTES: Pay attention to handling since it is liable to be affected by static electricity due to the high frequency process adopted.

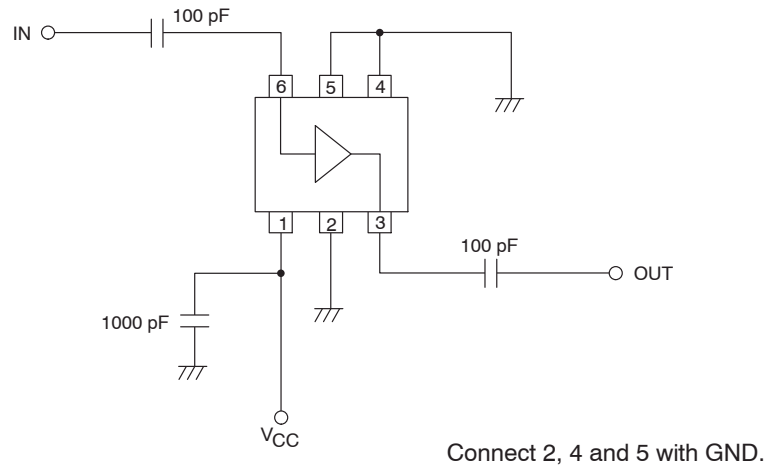
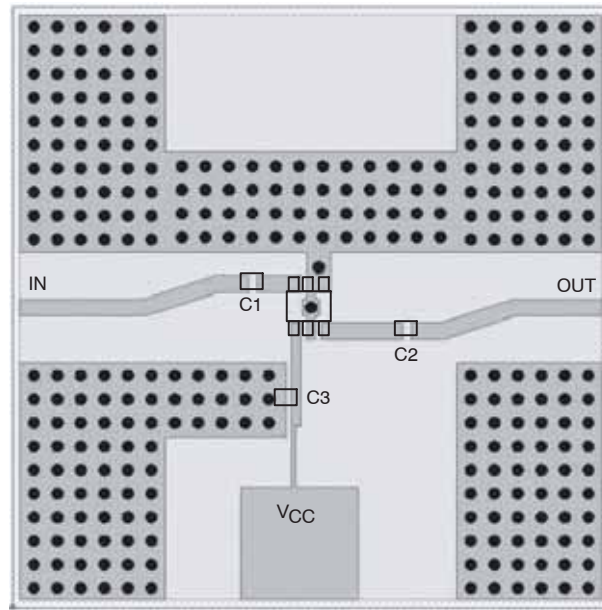

Figure 1. Test Circuit

SMA3107



Symbol	Value
C1, C2	100 pF
C3	1000 pF

Figure 2. Evaluation Board

TYPICAL PERFORMANCE CHARACTERISTICS

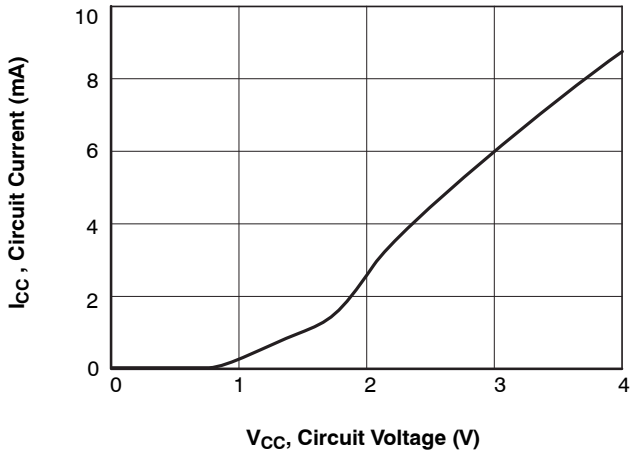

Figure 3. $I_{CC} - V_{CC}$

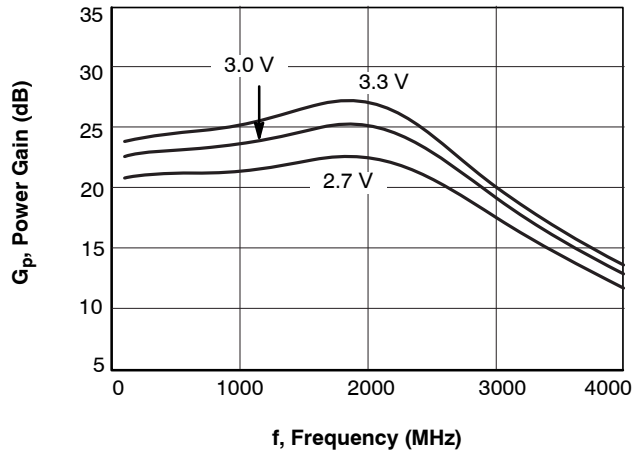

Figure 4. $G_p - f$

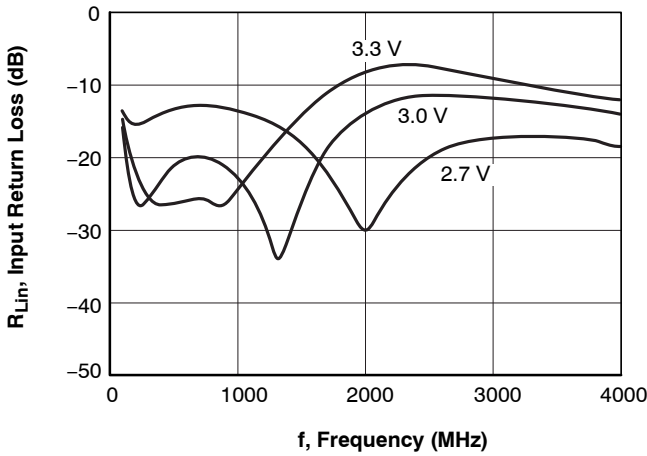

Figure 5. $R_{Lin} - f$

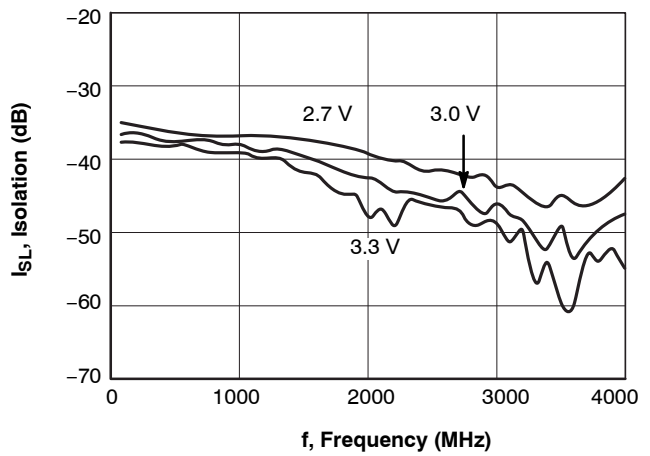

Figure 6. $I_{SL} - f$

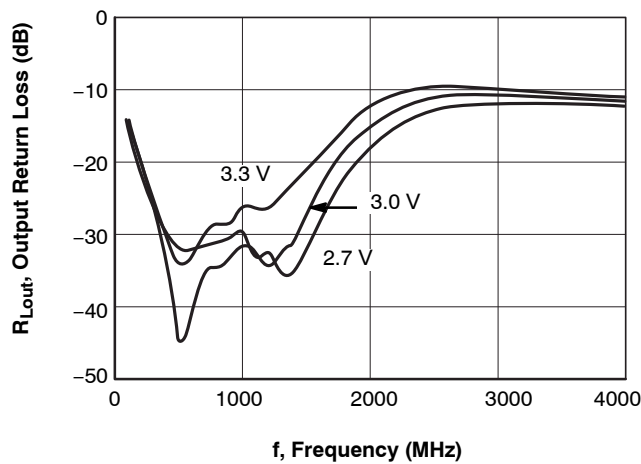

Figure 7. $R_{Lout} - f$

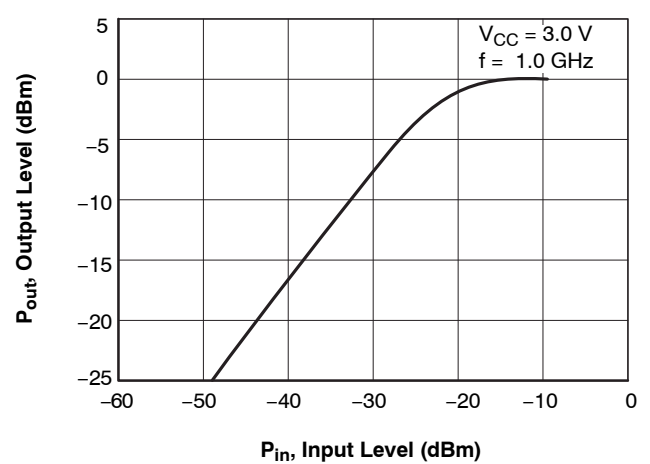

Figure 8. $P_{out} - P_{in}$

TYPICAL PERFORMANCE CHARACTERISTICS (continued)

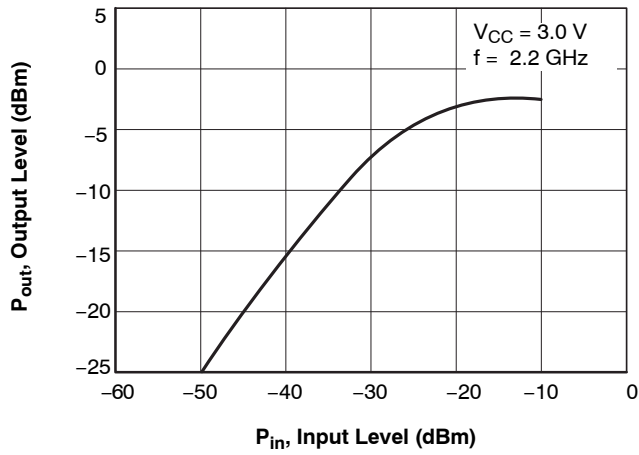

Figure 9. $P_{out} - P_{in}$

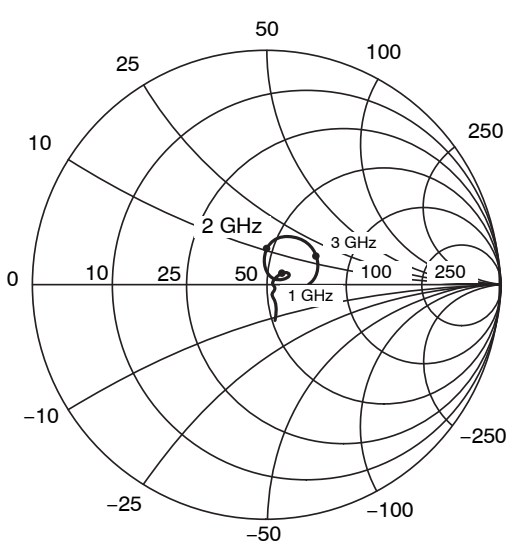

Figure 10. S Parameter, S_{11}

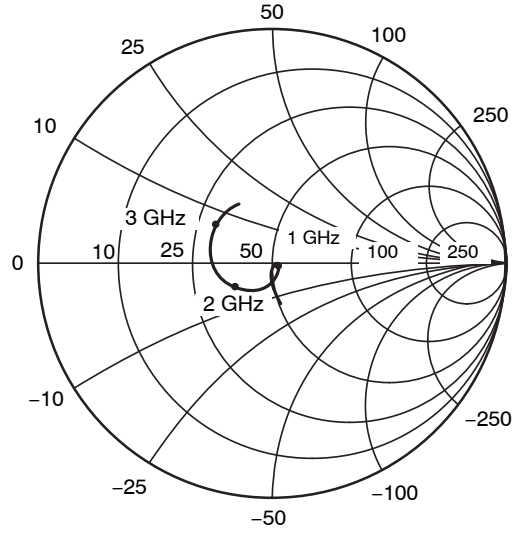
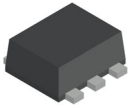

Figure 11. S Parameter, S_{22}

MECHANICAL CASE OUTLINE PACKAGE DIMENSIONS



SC-88FL / MCPH6
CASE 419AS
ISSUE A

DATE 28 SEP 2022

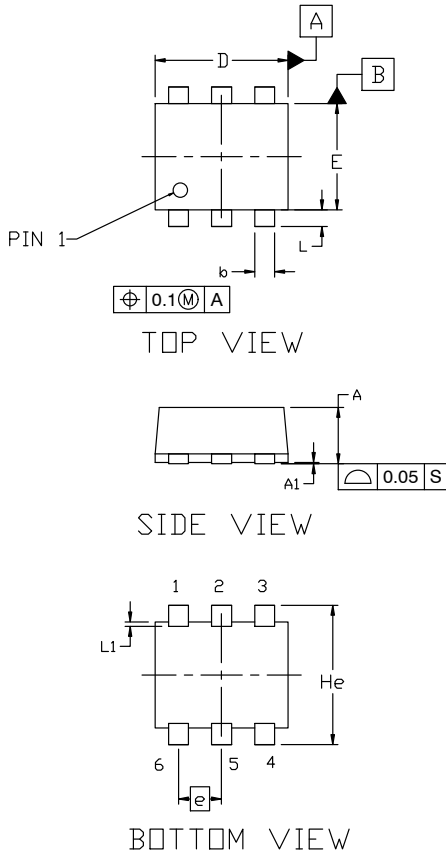

NOTES:

1. NO INDUSTRY STANDARD APPLIES TO THIS PACKAGE.
2. ALL DIMENSIONS ARE IN MILLIMETERS.
3. DIMENSIONS ARE EXCLUSIVE OF BURRS, MOLD FLASH AND THE BAR PROTRUSIONS.

DIM	MILLIMETERS		
	MIN.	NOM.	MAX.
A	0.80	0.85	0.90
A1	0.00	---	0.02
b	0.25	0.30	0.40
c	0.12	0.15	0.25
D	1.94	2.00	2.06
E	1.54	1.60	1.66
He	2.05	2.10	2.15
L	0.19	0.25	0.31
L1	0.00	0.07	0.12
e	0.65 BSC		

GENERIC MARKING DIAGRAM*

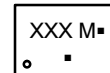

- XXX = Specific Device Code
- M = Date Code
- = Pb-Free Package

(Note: Microdot may be in either location)

*This information is generic. Please refer to device data sheet for actual part marking. Pb-Free indicator, "G" or microdot "▪", may or may not be present. Some products may not follow the Generic Marking.

DOCUMENT NUMBER:	98AON65646E	Electronic versions are uncontrolled except when accessed directly from the Document Repository. Printed versions are uncontrolled except when stamped "CONTROLLED COPY" in red.
DESCRIPTION:	SC-88FL / MCPH6	PAGE 1 OF 1

onsemi and ONSEMI are trademarks of Semiconductor Components Industries, LLC dba onsemi or its subsidiaries in the United States and/or other countries. onsemi reserves the right to make changes without further notice to any products herein. onsemi makes no warranty, representation or guarantee regarding the suitability of its products for any particular purpose, nor does onsemi assume any liability arising out of the application or use of any product or circuit, and specifically disclaims any and all liability, including without limitation special, consequential or incidental damages. onsemi does not convey any license under its patent rights nor the rights of others.

onsemi, **Onsemi**, and other names, marks, and brands are registered and/or common law trademarks of Semiconductor Components Industries, LLC dba "**onsemi**" or its affiliates and/or subsidiaries in the United States and/or other countries. **onsemi** owns the rights to a number of patents, trademarks, copyrights, trade secrets, and other intellectual property. A listing of **onsemi**'s product/patent coverage may be accessed at www.onsemi.com/site/pdf/Patent-Marking.pdf. **onsemi** reserves the right to make changes at any time to any products or information herein, without notice. The information herein is provided "as-is" and **onsemi** makes no warranty, representation or guarantee regarding the accuracy of the information, product features, availability, functionality, or suitability of its products for any particular purpose, nor does **onsemi** assume any liability arising out of the application or use of any product or circuit, and specifically disclaims any and all liability, including without limitation special, consequential or incidental damages. Buyer is responsible for its products and applications using **onsemi** products, including compliance with all laws, regulations and safety requirements or standards, regardless of any support or applications information provided by **onsemi**. "Typical" parameters which may be provided in **onsemi** data sheets and/or specifications can and do vary in different applications and actual performance may vary over time. All operating parameters, including "Typicals" must be validated for each customer application by customer's technical experts. **onsemi** does not convey any license under any of its intellectual property rights nor the rights of others. **onsemi** products are not designed, intended, or authorized for use as a critical component in life support systems or any FDA Class 3 medical devices or medical devices with a same or similar classification in a foreign jurisdiction or any devices intended for implantation in the human body. Should Buyer purchase or use **onsemi** products for any such unintended or unauthorized application, Buyer shall indemnify and hold **onsemi** and its officers, employees, subsidiaries, affiliates, and distributors harmless against all claims, costs, damages, and expenses, and reasonable attorney fees arising out of, directly or indirectly, any claim of personal injury or death associated with such unintended or unauthorized use, even if such claim alleges that **onsemi** was negligent regarding the design or manufacture of the part. **onsemi** is an Equal Opportunity/Affirmative Action Employer. This literature is subject to all applicable copyright laws and is not for resale in any manner.

ADDITIONAL INFORMATION

TECHNICAL PUBLICATIONS:

Technical Library: www.onsemi.com/design/resources/technical-documentation
onsemi Website: www.onsemi.com

ONLINE SUPPORT: www.onsemi.com/support

For additional information, please contact your local Sales Representative at www.onsemi.com/support/sales

Looking for pricing, stock, or lifecycle information?

Click below to explore more details on WIN SOURCE:

 [View SMA3107-TL-E on WIN SOURCE](#)

 [ON Semiconductor](#) Information

Optimize Your Supply Chain with WIN SOURCE Solutions

-  Global Sourcing Solution
-  Obsolete Management
-  Cost Control Management
-  Shortage Management
-  Alternative Solution
-  Excess Inventory Management