



**THE DATASHEET OF  
SKY67012-396LF**



DATA SHEET

# SKY67012-396LF: 300 to 600 MHz Low-Noise, Low-Current Amplifier

## Applications

- ISM, CDMA, TETRA, RFID, mobile broadcast, automobile-to-home control systems, Medical Micro-Power Networks
- General purpose LNAs

## Features

- Low NF: 0.85 dB @ 450 MHz
- Gain: 16.5 dB @ 450 MHz
- Flexible supply voltage from 1.8 to 5.0 V
- Adjustable supply current for higher IIP3
- Incorporates on-die stability structures
- Miniature DFN (8-pin, 2 x 2 mm) package (MSL1 @ 260 °C per JEDEC J-STD-020)



Skyworks Green™ products are compliant with all applicable legislation and are halogen-free. For additional information, refer to *Skyworks Definition of Green™*, document number SQ04-0074.

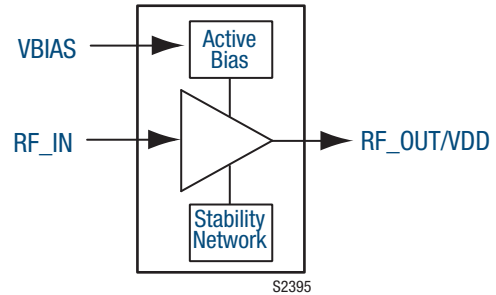

Figure 1. SKY67012-396LF Block Diagram

## Description

The SKY67012-396LF is a GaAs, pHEMT low-noise amplifier (LNA) with an integrated active bias. The advanced GaAs pHEMT enhancement mode process provides excellent return loss, low noise, and high linearity.

The device offers the ability to externally adjust the supply current. The supply voltage is applied to the RF-OUT/VDD pin through an RF choke inductor. The VBIAS pin should be connected to the RF\_OUT/VDD pin through an external resistor to control the supply current. Both RF\_OUT/VDD and RF\_IN pins should be DC blocked to ensure proper operation.

The SKY67012-396LF is manufactured in a compact, 2 x 2 mm, 8-pin Dual Flat No-Lead (DFN) package. A functional block diagram is shown in Figure 1. The pin configuration and package are shown in Figure 2. Signal pin assignments and functional pin descriptions are provided in Table 1.

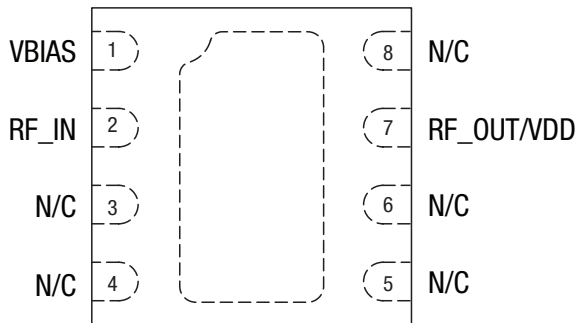

S2396

Figure 2. SKY67012-396LF Pinout – 8-Pin DFN (Top View)

**Table 1. SKY67012-396LF Signal Descriptions**

Pin	Name	Description	Pin	Name	Description
1	VBIAS	Bias for first stage amplifier. External resistor sets current consumption.	5	N/C	No connection. May be connected to ground with no change in performance.
2	RF_IN	RF input. DC blocking capacitor required.	6	N/C	No connection. May be connected to ground with no change in performance.
3	N/C	No connection. May be connected to ground with no change in performance.	7	RF_OUT/VDD	RF output. Apply VDD through RF choke inductor. DC blocking capacitor required.
4	N/C	No connection. May be connected to ground with no change in performance.	8	N/C	No connection. May be connected to ground with no change in performance.

**Electrical and Mechanical Specifications**

The absolute maximum ratings of the SKY67012-396LF are provided in Table 2. Electrical specifications are provided in Tables 3 (15 mA operation) and 4 (5 mA operation).

Typical performance characteristics of the SKY67012-396LF are illustrated in Figures 3 through 26.

**Table 2. SKY67012-396LF Absolute Maximum Ratings (Note 1)**

Parameter	Symbol	Minimum	Typical	Maximum	Units
Supply voltage	V <sub>DD</sub>		3.3	5.5	V
Drain current	I <sub>DD</sub>		15	50	mA
RF input power	P <sub>IN</sub>			+18	dBm
Storage temperature	T <sub>STG</sub>	-65	+25	+125	°C
Operating temperature	T <sub>A</sub>	-40	+25	+85	°C
Thermal resistance	Θ <sub>JC</sub>		128		°C/W
Electrostatic discharge: Human Body Model (HBM), Class 1A	ESD			500	V

**Note 1:** Exposure to maximum rating conditions for extended periods may reduce device reliability. There is no damage to device with only one parameter set at the limit and all other parameters set at or below their nominal value. Exceeding any of the limits listed here may result in permanent damage to the device.

**CAUTION:** Although this device is designed to be as robust as possible, electrostatic discharge (ESD) can damage this device. This device must be protected at all times from ESD. Static charges may easily produce potentials of several kilovolts on the human body or equipment, which can discharge without detection. Industry-standard ESD precautions should be used at all times.

**Table 3. SKY67012-396LF Electrical Specifications: Supply Current = 15 mA (Note 1)**  
**(V<sub>DD</sub> = 3.3 V, T<sub>A</sub> = +25 °C, P<sub>IN</sub> = -20 dBm, Characteristic Impedance [Z<sub>0</sub>] = 50 Ω, Tuning Optimized for 450 MHz, Unless Otherwise Noted)**

Parameter	Symbol	Test Condition	Min	Typical	Max	Units
<b>RF Specifications</b>						
Noise figure	NF			0.85	1.1	dB
Small signal gain	IS21I		15.0	16.5		dB
Input return loss	IS11I			20		dB
Output return loss	IS22I			12		dB
Reverse isolation	IS12I			26		dB
Third Order Input Intercept Point	IIP3	$\Delta f = 1$ MHz, P <sub>IN</sub> = -20 dBm/tone	+4.5	+7.5		dBm
Third order output intercept point	OIP3	$\Delta f = 1$ MHz, P <sub>IN</sub> = -20 dBm/tone	+21	+24		dBm
1 dB input compression point	IP1dB		-3.5	-1.5		dBm
1 dB output compression point	OP1dB		+12	+14		dBm
<b>DC Specifications</b>						
Supply voltage	V <sub>DD</sub>			3.3		V
Quiescent current	I <sub>DDQ</sub>	Set with external resistor	10	15		mA

**Note 1:** Performance is guaranteed only under the conditions listed in this table.

**Table 4. SKY67012-396LF Electrical Specifications: Supply Current = 5 mA (Note 1)**  
**(V<sub>DD</sub> = 3.3 V, T<sub>A</sub> = +25 °C, P<sub>IN</sub> = -20 dBm, Characteristic Impedance [Z<sub>0</sub>] = 50 Ω, Tuning Optimized for 450 MHz, Unless Otherwise Noted)**

Parameter	Symbol	Test Condition	Min	Typical	Max	Units
<b>RF Specifications</b>						
Noise figure	NF			1		dB
Small signal gain	IS21I			15.5		dB
Input return loss	IS11I			20		dB
Output return loss	IS22I			13		dB
Reverse isolation	IS12I			24		dB
Third order input intercept point	IIP3	$\Delta f = 1$ MHz, P <sub>IN</sub> = -20 dBm/tone		+2.5		dBm
Third order output intercept point	OIP3	$\Delta f = 1$ MHz, P <sub>IN</sub> = -20 dBm/tone		+18		dBm
1 dB input compression point	IP1dB			+0.5		dBm
1 dB output compression point	OP1dB			+15		dBm
<b>DC Specifications</b>						
Supply voltage	V <sub>DD</sub>			3.3		V
Quiescent current	I <sub>DDQ</sub>	Set with external resistor		5		mA

**Note 1:** Performance is guaranteed only under the conditions listed in this table.

### Typical Performance Characteristics

(VDD = 3.3 V, Quiescent Current = 15 mA, TA = +25 °C, Pin = -20 dBm, Characteristic Impedance [Zo] = 50 Ω, Tuning Optimized for 450 MHz, Unless Otherwise Noted)

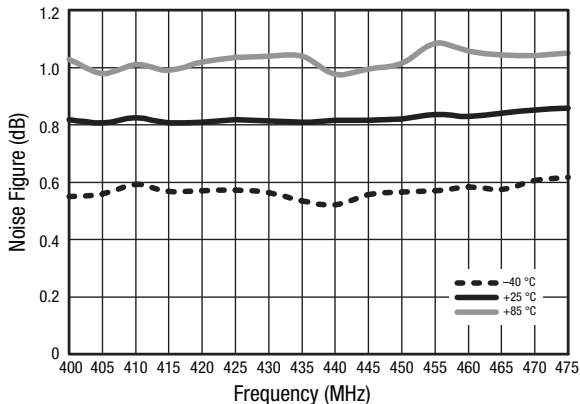

**Figure 3. Noise Figure vs Frequency and Temperature, Narrow Band (Includes EVB Insertion Losses)**

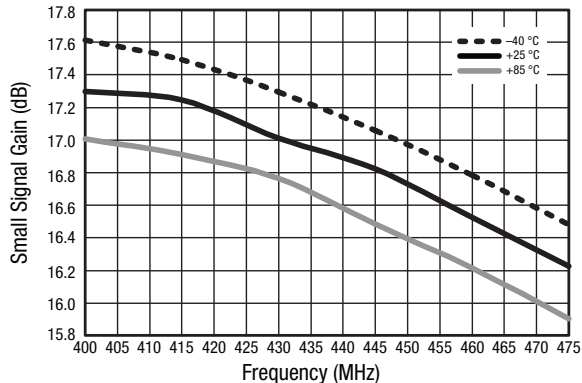

**Figure 4. Small Signal Gain (IS21) vs Frequency and Temperature, Narrow Band**

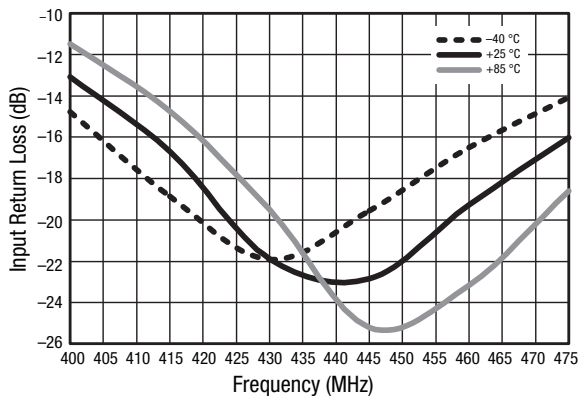

**Figure 5. Small Signal Input Return Loss (IS11) vs Frequency and Temperature, Narrow Band**

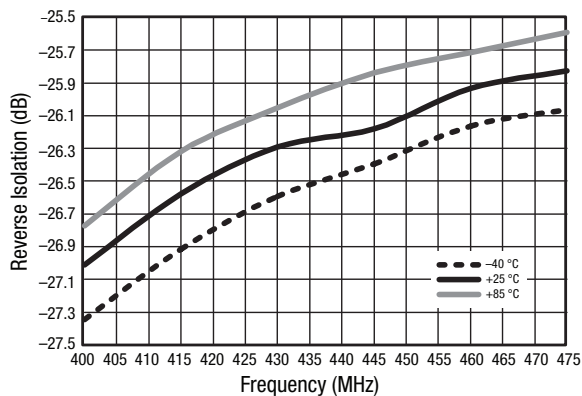

**Figure 6. Small Signal Reverse Isolation (IS12) vs Frequency and Temperature, Narrow Band**

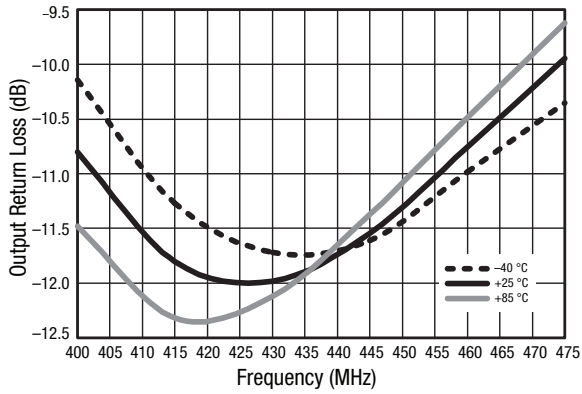

**Figure 7. Small Signal Output Return Loss (IS22I) vs Frequency and Temperature, Narrow Band**

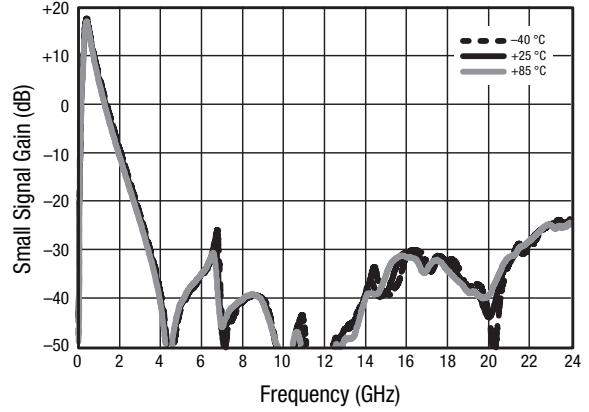

**Figure 8. Small Signal Gain (IS21I) vs Frequency and Temperature, Wide Band**

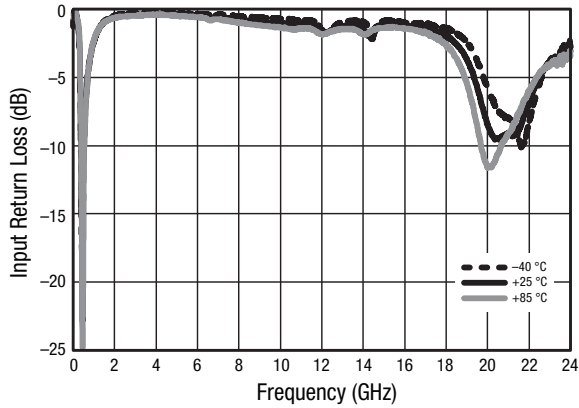

**Figure 9. Small Signal Input Return Loss (IS11I) vs Frequency and Temperature, Wide Band**

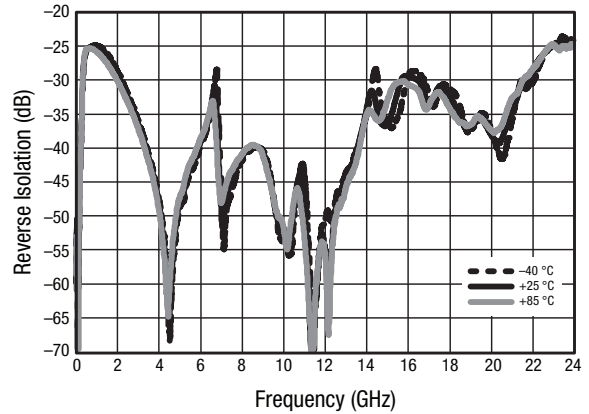

**Figure 10. Small Signal Reverse Isolation (IS12I) vs Frequency and Temperature, Wide Band**

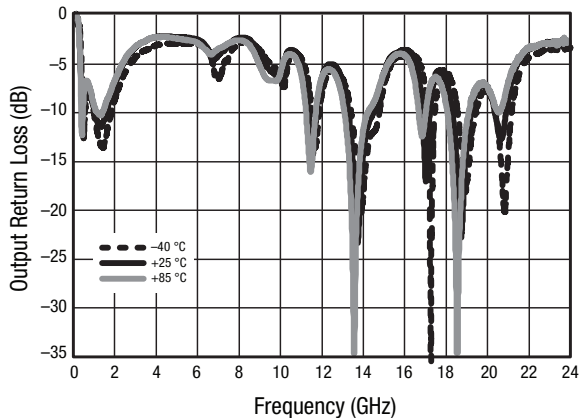

Figure 11. Small Signal Output Return Loss (S22) vs Frequency and Temperature, Wide Band

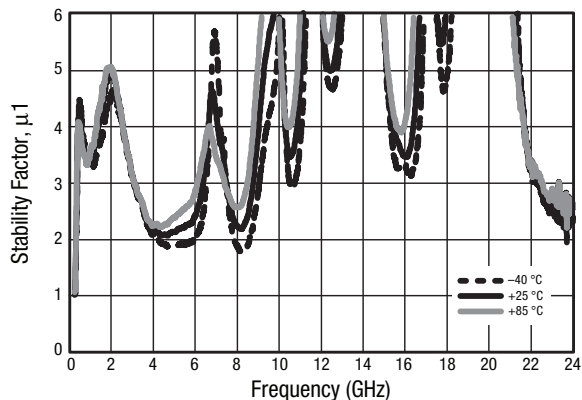

Figure 12. Stability Factor ( $\mu_1$ ) vs Frequency and Temperature, Wide Band

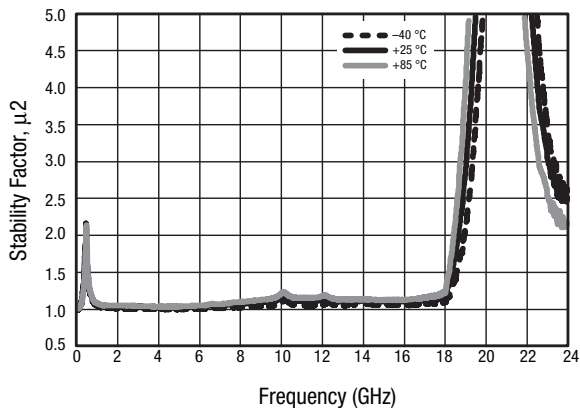

Figure 13. Stability Factor ( $\mu_2$ ) vs Frequency and Temperature, Wide Band

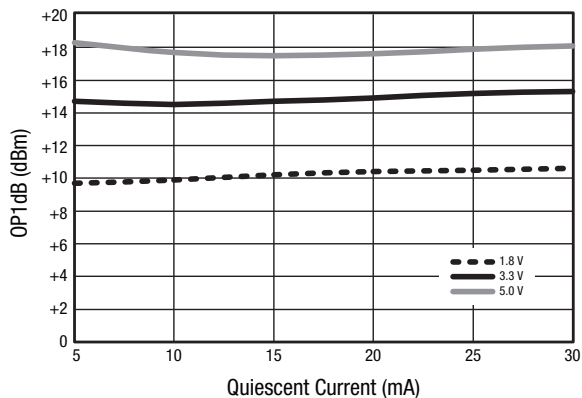

Figure 14. OP1dB vs Quiescent Current

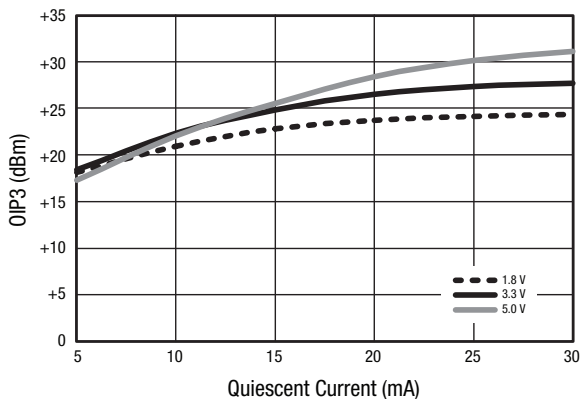
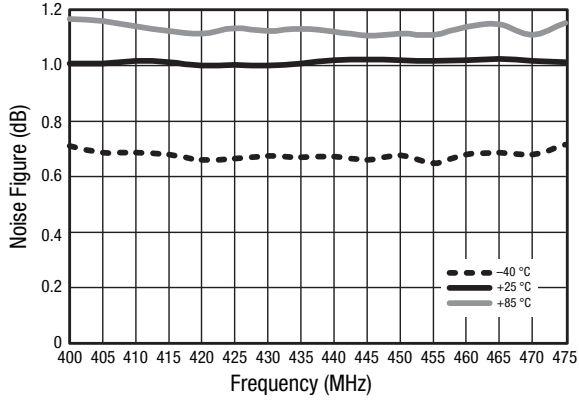

Figure 15. OIP3 vs Quiescent Current

### Typical Performance Characteristics

(VDD = 3.3 V, Quiescent Current = 5 mA, TA = +25 °C, Pin = -20 dBm, Characteristic Impedance [Zo] = 50 Ω, Tuning Optimized for 450 MHz, Unless Otherwise Noted)



**Figure 16. Noise Figure vs Frequency and Temperature, Narrow Band (Includes EVB Insertion Losses)**

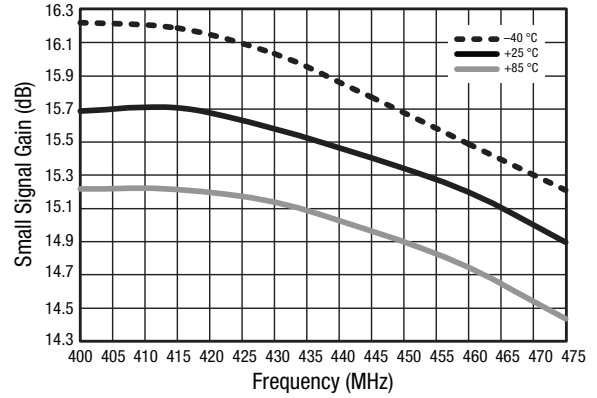

**Figure 17. Small Signal Gain (IS21) vs Frequency and Temperature, Narrow Band**

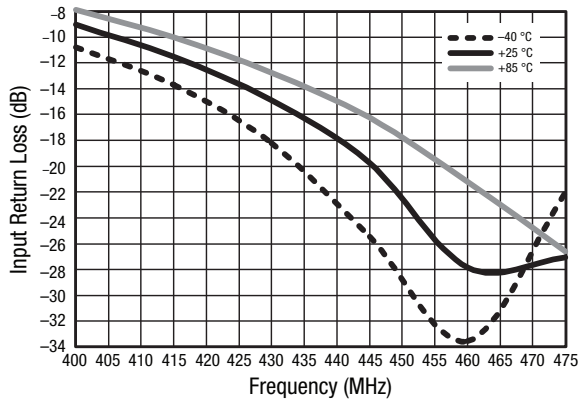

**Figure 18. Small Signal Input Return Loss (IS11) vs Frequency and Temperature, Narrow Band**

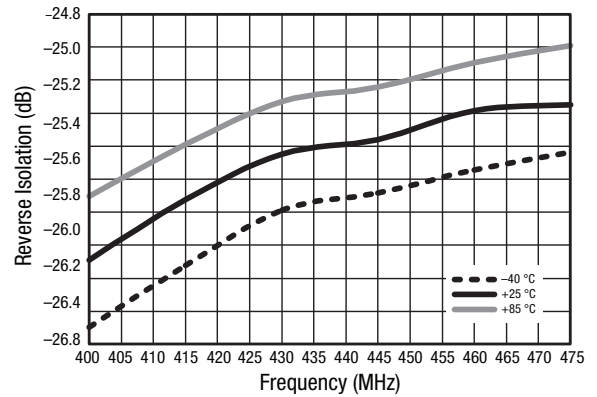

**Figure 19. Small Signal Reverse Isolation (IS12) vs Frequency and Temperature, Narrow Band**

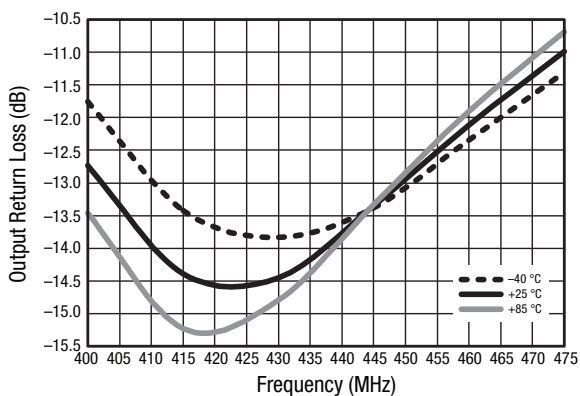

Figure 20. Small Signal Output Return Loss (IS22I) vs Frequency and Temperature, Narrow Band

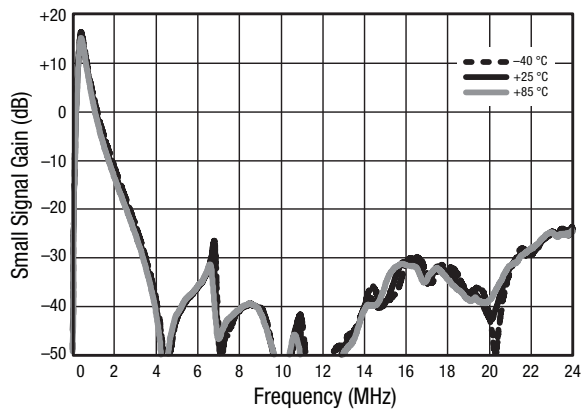

Figure 21. Small Signal Gain (IS21I) vs Frequency and Temperature, Wide Band

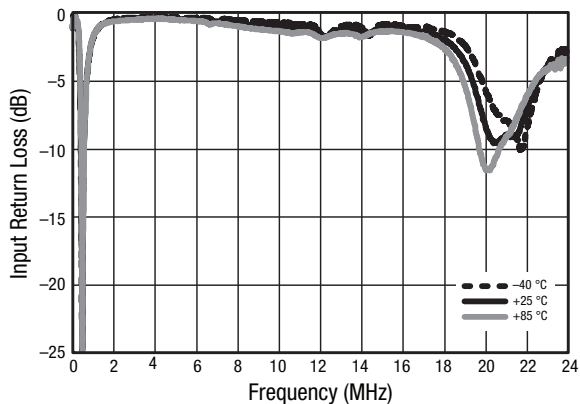

Figure 22. Small Signal Input Return Loss (IS11I) vs Frequency and Temperature, Wide Band

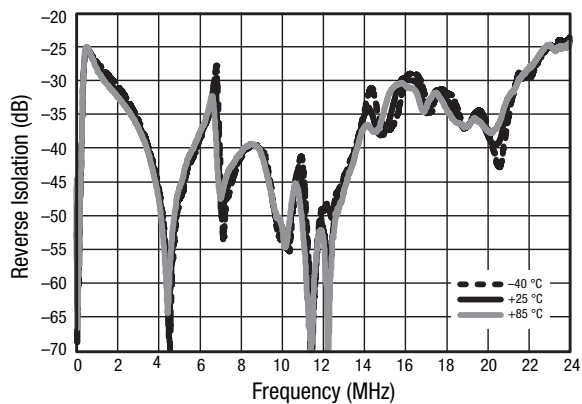
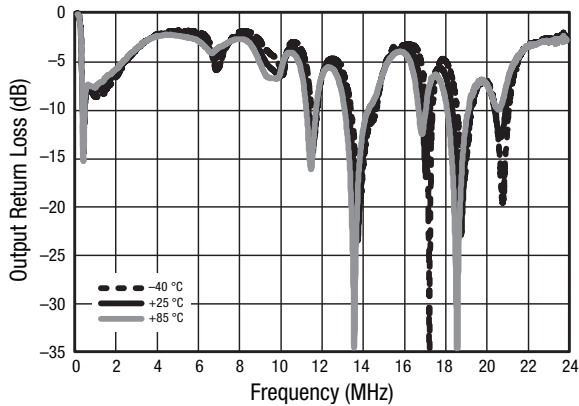
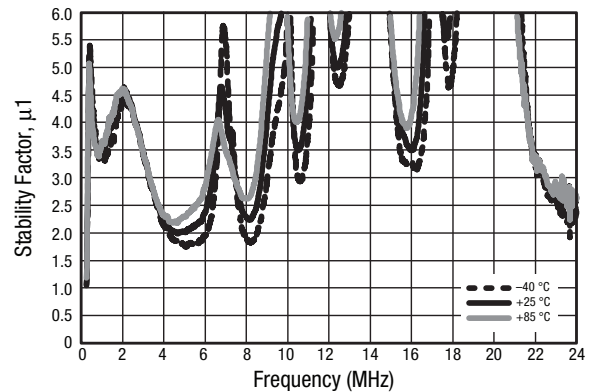

Figure 23. Small Signal Reverse Isolation (IS12I) vs Frequency and Temperature, Wide Band



**Figure 24. Small Signal Output Return Loss (S22) vs Frequency and Temperature, Wide Band**



**Figure 25. Stability Factor ( $\mu_1$ ) vs Frequency and Temperature, Wide Band**

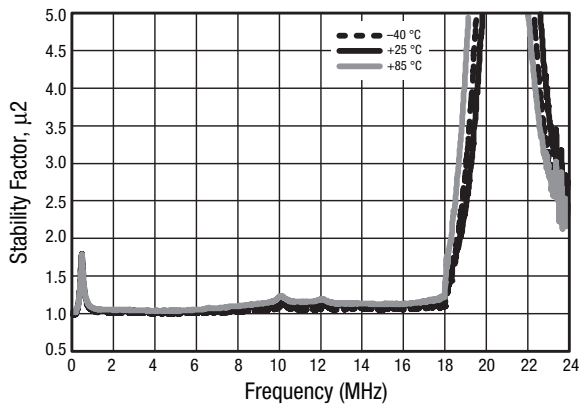

**Figure 26. Stability Factor ( $\mu_2$ ) vs Frequency and Temperature, Wide Band**

### Evaluation Board Description

The SKY67012-396LF Evaluation Board is used to test the performance of the SKY67012-396LF LNA. An assembly drawing for the Evaluation Board is shown in Figure 27. An Evaluation Board schematic diagram is provided in Figure 28. Table 5 provides the Bill of Materials (BOM) list for Evaluation Board components.

### Package Dimensions

The PCB layout footprint for the SKY67012-396LF is provided in Figure 29. Typical part markings are shown in Figure 30. Package dimensions for the 8-pin DFN are shown in Figure 31, and tape and reel dimensions are provided in Figure 32.

### Package and Handling Information

Instructions on the shipping container label regarding exposure to moisture after the container seal is broken must be followed. Otherwise, problems related to moisture absorption may occur when the part is subjected to high temperature during solder assembly.

The SKY67012-396LF is rated to Moisture Sensitivity Level 1 (MSL1) at 260 °C. It can be used for lead or lead-free soldering. For additional information, refer to the Skyworks Application Note, *Solder Reflow Information*, document number 200164.

Care must be taken when attaching this product, whether it is done manually or in a production solder reflow environment. Production quantities of this product are shipped in a standard tape and reel format.

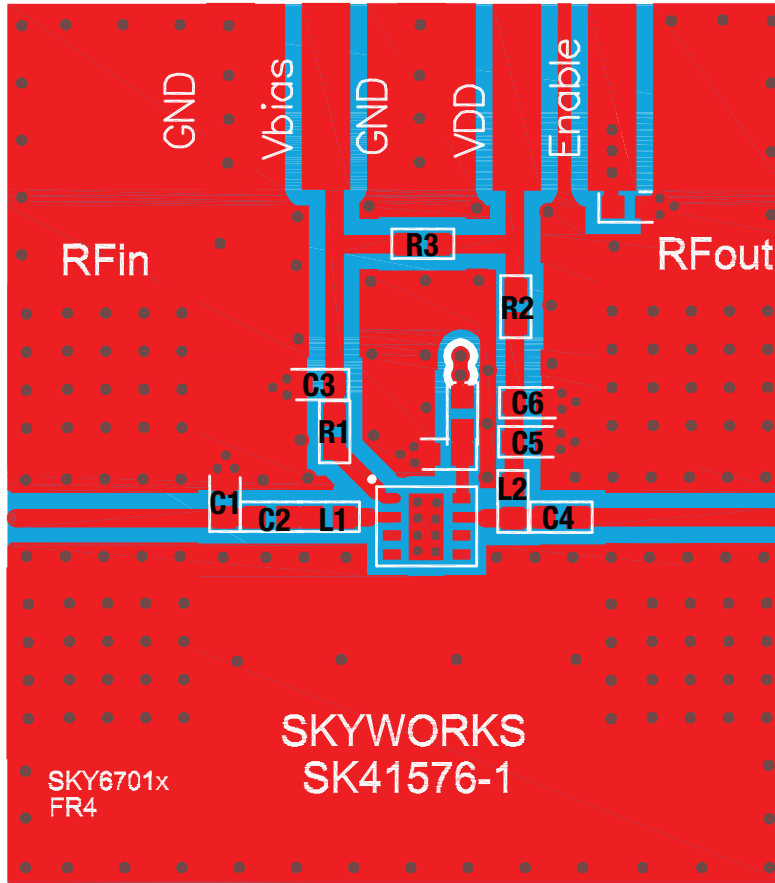

S2394

Figure 27. SKY67012-396LF Evaluation Board Assembly Diagram

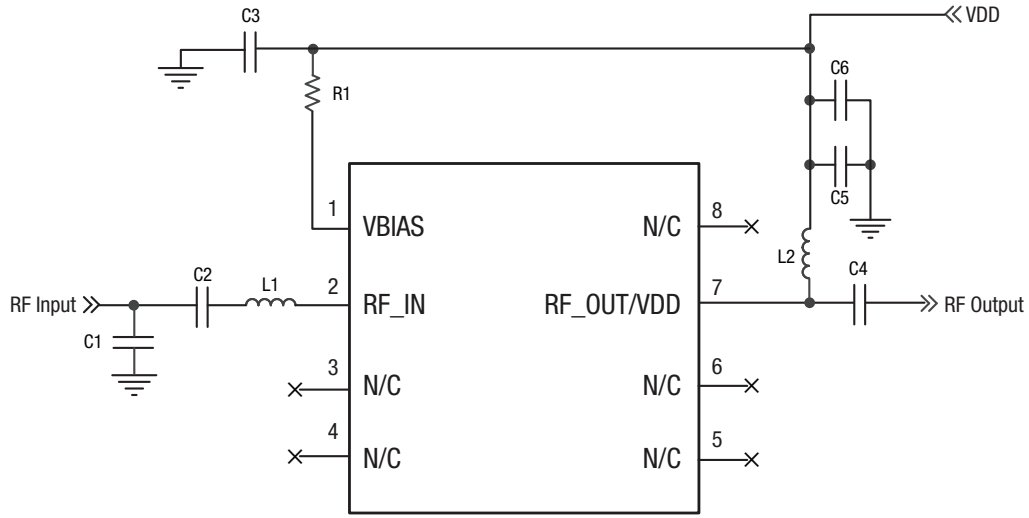

S2397

Figure 28. SKY67012-396LF Evaluation Board Schematic

Table 5. SKY67012-396LF Evaluation Board Bill of Materials

Component	Value	Size	Manufacturer
C1	0.5 pF	0402	Murata GJM
C2	10 pF	0402	Murata GJM
C3	10 pF	0402	Murata GRM
C4	4.7 pF	0402	Murata GRM
C5	10000 pF	0402	Murata GRM
C6	0.5 pF	0402	Murata GRM
L1	33 nH	0402	Murata LQW
L2	22 nH	0402	Murata LQG
R1 (Note 1)	4.7 k $\Omega$	0402	Panasonic
R2	0 $\Omega$	0402	Panasonic
R3	0 $\Omega$	0402	Panasonic

Note 1: Use 18 k $\Omega$  for R1 to achieve 5 mA of quiescent current with 3.3 V VDD.

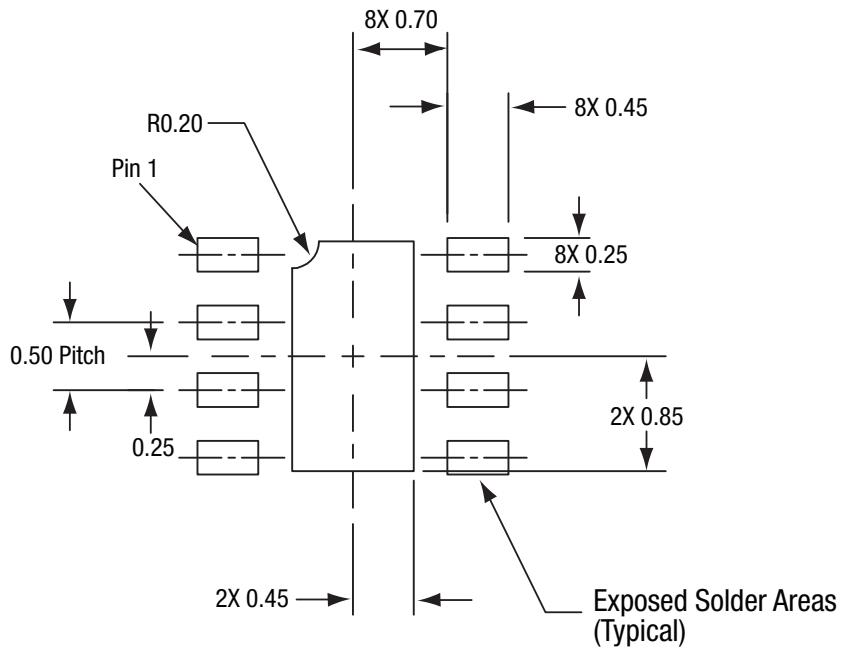

S1413

**Figure 29. SKY67012-396LF PCB Layout Footprint (Top View)**

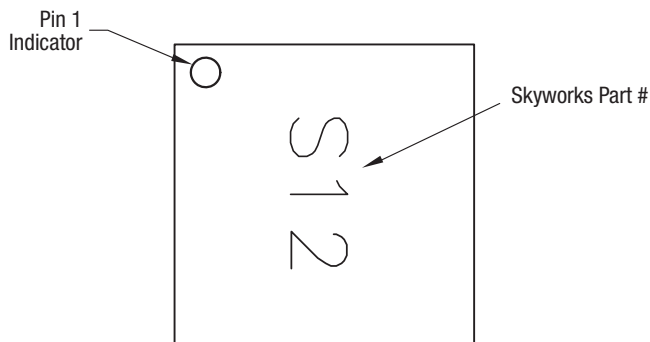

**Figure 30. Typical Part Markings (Top View)**

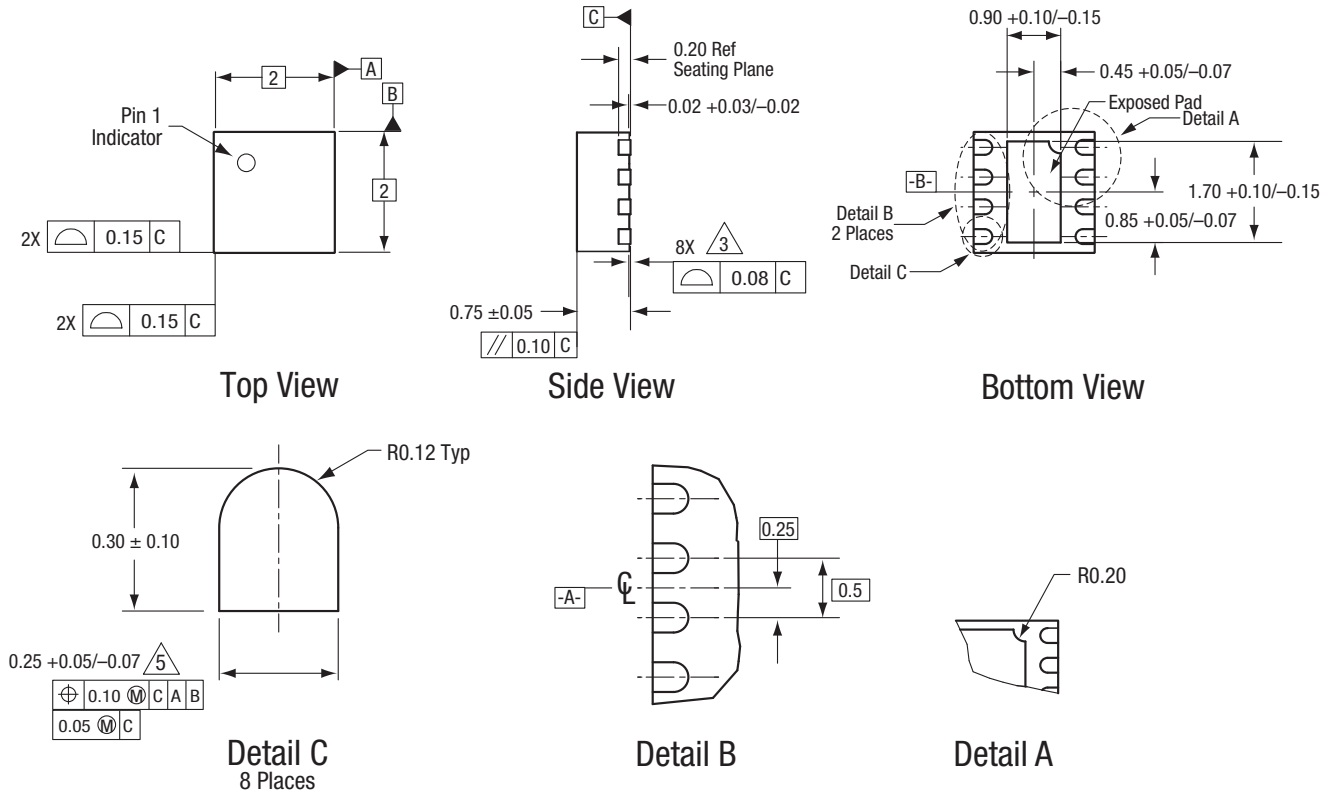

All measurements are in millimeters.  
 Dimensioning and tolerancing according to ASME Y14.5M-1994.  
 Coplanarity applies to the exposed heat sink slug as well as the terminals.  
 Plating requirement per source control drawing (SCD) 2504.  
 Dimension applies to metallized terminal and is measured between 0.15 mm and 0.30 mm from terminal tip.

S1945

Figure 31. SKY67012-396LF 8-Pin DFN Package Dimensions

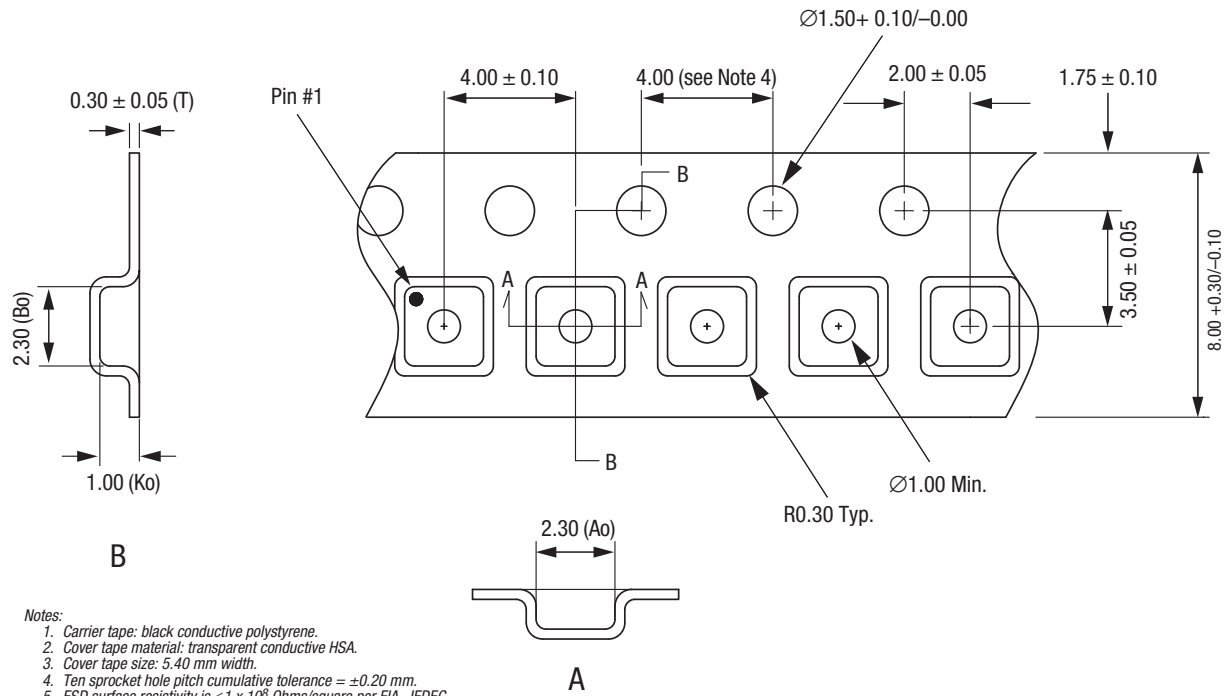

- Notes:
1. Carrier tape: black conductive polystyrene.
  2. Cover tape material: transparent conductive HSA.
  3. Cover tape size: 5.40 mm width.
  4. Ten sprocket hole pitch cumulative tolerance =  $\pm 0.20$  mm.
  5. ESD surface resistivity is  $\leq 1 \times 10^9$  Ohms/square per EIA, JEDEC tape and reel specification.
  6. Ao and Bo measurement point to be 0.30 mm from bottom pocket.
  7. All measurements are in millimeters.

S1601

Figure 32. SKY67012-396LF Tape and Reel Dimensions

## Ordering Information

Model Name	Manufacturing Part Number	Evaluation Board Part Number
SKY67012-396LF: Low-Noise, Low-Current Amplifier	SKY67012-396LF	SKY67012-396LF-EVB

Copyright © 2011, 2014-2015 Skyworks Solutions, Inc. All Rights Reserved.

Information in this document is provided in connection with Skyworks Solutions, Inc. ("Skyworks") products or services. These materials, including the information contained herein, are provided by Skyworks as a service to its customers and may be used for informational purposes only by the customer. Skyworks assumes no responsibility for errors or omissions in these materials or the information contained herein. Skyworks may change its documentation, products, services, specifications or product descriptions at any time, without notice. Skyworks makes no commitment to update the materials or information and shall have no responsibility whatsoever for conflicts, incompatibilities, or other difficulties arising from any future changes.

No license, whether express, implied, by estoppel or otherwise, is granted to any intellectual property rights by this document. Skyworks assumes no liability for any materials, products or information provided hereunder, including the sale, distribution, reproduction or use of Skyworks products, information or materials, except as may be provided in Skyworks Terms and Conditions of Sale.

THE MATERIALS, PRODUCTS AND INFORMATION ARE PROVIDED "AS IS" WITHOUT WARRANTY OF ANY KIND, WHETHER EXPRESS, IMPLIED, STATUTORY, OR OTHERWISE, INCLUDING FITNESS FOR A PARTICULAR PURPOSE OR USE, MERCHANTABILITY, PERFORMANCE, QUALITY OR NON-INFRINGEMENT OF ANY INTELLECTUAL PROPERTY RIGHT; ALL SUCH WARRANTIES ARE HEREBY EXPRESSLY DISCLAIMED. SKYWORKS DOES NOT WARRANT THE ACCURACY OR COMPLETENESS OF THE INFORMATION, TEXT, GRAPHICS OR OTHER ITEMS CONTAINED WITHIN THESE MATERIALS. SKYWORKS SHALL NOT BE LIABLE FOR ANY DAMAGES, INCLUDING BUT NOT LIMITED TO ANY SPECIAL, INDIRECT, INCIDENTAL, STATUTORY, OR CONSEQUENTIAL DAMAGES, INCLUDING WITHOUT LIMITATION, LOST REVENUES OR LOST PROFITS THAT MAY RESULT FROM THE USE OF THE MATERIALS OR INFORMATION, WHETHER OR NOT THE RECIPIENT OF MATERIALS HAS BEEN ADVISED OF THE POSSIBILITY OF SUCH DAMAGE.



Skyworks products are not intended for use in medical, lifesaving or life-sustaining applications, or other equipment in which the failure of the Skyworks products could lead to personal injury, death, physical or environmental damage. Skyworks customers using or selling Skyworks products for use in such applications do so at their own risk and agree to fully indemnify Skyworks for any damages resulting from such improper use or sale.

Customers are responsible for their products and applications using Skyworks products, which may deviate from published specifications as a result of design defects, errors, or operation of products outside of published parameters or design specifications. Customers should include design and operating safeguards to minimize these and other risks. Skyworks assumes no liability for applications assistance, customer product design, or damage to any equipment resulting from the use of Skyworks products outside of stated published specifications or parameters.

Skyworks and the Skyworks symbol are trademarks or registered trademarks of Skyworks Solutions, Inc., in the United States and other countries. Third-party brands and names are for identification purposes only, and are the property of their respective owners. Additional information, including relevant terms and conditions, posted at [www.skyworksinc.com](http://www.skyworksinc.com), are incorporated by reference.

## Looking for pricing, stock, or lifecycle information?

Click below to explore more details on WIN SOURCE:

-  [View SKY67012-396LF on WIN SOURCE](#)
-  [Skyworks Solutions Inc. Information](#)

## Optimize Your Supply Chain with WIN SOURCE Solutions

-  Global Sourcing Solution
-  Obsolete Management
-  Cost Control Management
-  Shortage Management
-  Alternative Solution
-  Excess Inventory Management