



**THE DATASHEET OF  
SKY67015-396LF**



**DATA SHEET**

# SKY67015-396LF: 30 to 300 MHz Low-Noise, Low-Current Amplifier

## Applications

- Military and public safety VHF radios
- General purpose, low power PAs and LNAs
- Wireless sensors
- Automated metering infrastructure

## Features

- Low NF: 0.8 dB @ 150 MHz
- Gain: 18.5 dB @ 150 MHz
- Flexible supply voltage from 1.8 to 5.0 V
- Adjustable supply current for higher IIP3
- Improved NF and linearity compared to SiGe LNAs
- Incorporates on-die stability structures
- Miniature DFN (8-pin, 2 x 2 mm) package (MSL1 @ 260 °C per JEDEC J-STD-020)



Skyworks Green™ products are compliant with all applicable legislation and are halogen-free. For additional information, refer to *Skyworks Definition of Green™*, document number SQ04-0074.

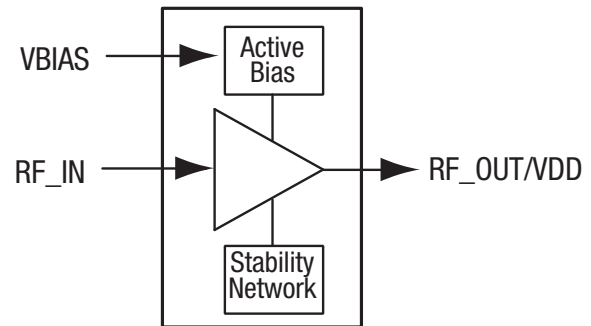

S2395

**Figure 1. SKY67015-396LF Block Diagram**

## Description

The SKY67015-396LF is a GaAs, pHEMT low-noise amplifier (LNA) with an integrated active bias. The advanced GaAs pHEMT enhancement mode process provides excellent return loss, low noise, and high linearity.

The SKY67015-396LF is typically used at frequencies ranging from 100 MHz to 300 MHz. The device has been successfully tuned down to 30 MHz with the addition of external RC feedback. Please contact Skyworks for details.

The device offers the ability to externally adjust the supply current. The supply voltage is applied to the RF-OUT/VDD pin through an RF choke inductor. The VBIAS pin should be connected to the RF\_OUT/VDD pin through an external resistor to control the supply current. Both RF\_OUT/VDD and RF\_IN pins should be DC blocked to ensure proper operation.

The SKY67015-396LF is manufactured in a compact, 2 x 2 mm, 8-pin Dual Flat No-Lead (DFN) package. A functional block diagram is shown in Figure 1. The pin configuration and package are shown in Figure 2. Signal pin assignments and functional pin descriptions are provided in Table 1.

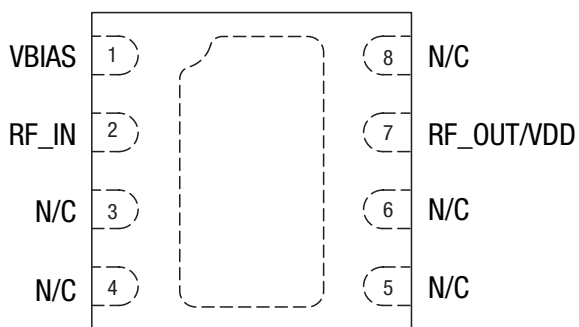

S2396

**Figure 2. SKY67015-396LF Pinout – 8-Pin DFN (Top View)**

**Table 1. SKY67015-396LF Signal Descriptions**

Pin	Name	Description	Pin	Name	Description
1	VBIAS	Bias for first stage amplifier. External resistor sets current consumption.	5	N/C	No connection. May be connected to ground with no change in performance.
2	RF_IN	RF input. DC blocking capacitor required.	6	N/C	No connection. May be connected to ground with no change in performance.
3	N/C	No connection. May be connected to ground with no change in performance.	7	RF_OUT/VDD	RF output. Apply VDD through RF choke inductor. DC blocking capacitor required.
4	N/C	No connection. May be connected to ground with no change in performance.	8	N/C	No connection. May be connected to ground with no change in performance.

**Table 2. SKY67015-396LF Absolute Maximum Ratings (Note 1)**

Parameter	Symbol	Minimum	Maximum	Units
Supply voltage	V <sub>DD</sub>		5.5	V
Drain current	I <sub>DD</sub>		40	mA
RF input power	P <sub>IN</sub>		+18	dBm
Storage temperature	T <sub>STG</sub>	-65	+125	°C
Operating temperature	T <sub>A</sub>	-40	+85	°C
Thermal resistance	Θ <sub>JC</sub>		128	°C/W
Electrostatic discharge:	ESD			
Charged Device Model (CDM), Class 2			250	V
Human Body Model (HBM), Class 1A			300	V
Machine Model (MM), Class A			30	V

**Note 1:** Exposure to maximum rating conditions for extended periods may reduce device reliability. There is no damage to device with only one parameter set at the limit and all other parameters set at or below their nominal value. Exceeding any of the limits listed here may result in permanent damage to the device.

**CAUTION:** Although this device is designed to be as robust as possible, electrostatic discharge (ESD) can damage this device. This device must be protected at all times from ESD. Static charges may easily produce potentials of several kilovolts on the human body or equipment, which can discharge without detection. Industry-standard ESD precautions should be used at all times.

**Electrical and Mechanical Specifications**

The absolute maximum ratings of the SKY67015-396LF are provided in Table 2. Electrical specifications are provided in Tables 3 (18 mA operation) and 4 (5 mA operation).

Typical performance characteristics of the SKY67015-396LF are illustrated in Figures 3 through 15.

**Table 3. SKY67015-396LF Electrical Specifications: Supply Current = 18 mA (Note 1)**  
**(V<sub>DD</sub> = 3.3 V, T<sub>A</sub> = +25 °C, P<sub>IN</sub> = -20 dBm, Characteristic Impedance [Z<sub>0</sub>] = 50 Ω, Reference Frequency = 250 MHz, Unless Otherwise Noted)**

Parameter	Symbol	Test Condition	Min	Typical	Max	Units
<b>RF Specifications</b>						
Noise Figure	NF			0.8	1.0	dB
Small signal gain	IS21I		15.5	17.5		dB
Input return loss	IS11I			17		dB
Output return loss	IS22I			17		dB
Reverse isolation	IS12I			24		dB
3 <sup>rd</sup> Order Input Intercept Point	IIP3	$\Delta f = 1 \text{ MHz}$ , P <sub>IN</sub> = -20 dBm/tone	+3.5	+7.5		dBm
3 <sup>rd</sup> Order Output Intercept Point	OIP3	$\Delta f = 1 \text{ MHz}$ , P <sub>IN</sub> = -20 dBm/tone	+21	+25		dBm
1 dB Input Compression Point	IP1dB		-6.5	-4.0		dBm
1 dB Output Compression Point	OP1dB		+10.0	+12.5		dBm
<b>DC Specifications</b>						
Supply voltage	V <sub>DD</sub>			3.3		V
Quiescent current	I <sub>DDQ</sub>	Set with external resistor		18		mA

Note 1: Performance is guaranteed only under the conditions listed in this table.

**Table 4. SKY67015-396LF Electrical Specifications: Supply Current = 5 mA (Note 1)**  
**(V<sub>DD</sub> = 3.3 V, T<sub>A</sub> = +25 °C, P<sub>IN</sub> = -20 dBm, Characteristic Impedance [Z<sub>0</sub>] = 50 Ω, Reference Frequency = 250 MHz, Unless Otherwise Noted)**

Parameter	Symbol	Test Condition	Min	Typical	Max	Units
<b>RF Specifications</b>						
Noise Figure	NF			1.05		dB
Small signal gain	IS21I			15.5		dB
Input return loss	IS11I			16		dB
Output return loss	IS22I			14		dB
Reverse isolation	IS12I			23		dB
3 <sup>rd</sup> Order Input Intercept Point	IIP3	$\Delta f = 1 \text{ MHz}$ , P <sub>IN</sub> = -20 dBm/tone		0.5		dBm
3 <sup>rd</sup> Order Output Intercept Point	OIP3	$\Delta f = 1 \text{ MHz}$ , P <sub>IN</sub> = -20 dBm/tone		+16		dBm
1 dB Input Compression Point	IP1dB			-2.5		dBm
1 dB Output Compression Point	OP1dB			+12		dBm
<b>DC Specifications</b>						
Supply voltage	V <sub>DD</sub>			3.3		V
Quiescent current	I <sub>DDQ</sub>	Set with external resistor		5		mA

Note 1: Performance is guaranteed only under the conditions listed in this table.

### Typical Performance Characteristics

( $V_{DD} = 3.3\text{ V}$ ,  $I_{DDQ} = 18\text{ mA}$ ,  $T_A = +25\text{ }^\circ\text{C}$ ,  $P_{IN} = -20\text{ dBm}$ , Characteristic Impedance [ $Z_0$ ] =  $50\ \Omega$ , Tuning Optimized for 100 MHz to 250 MHz, Unless Otherwise Noted)

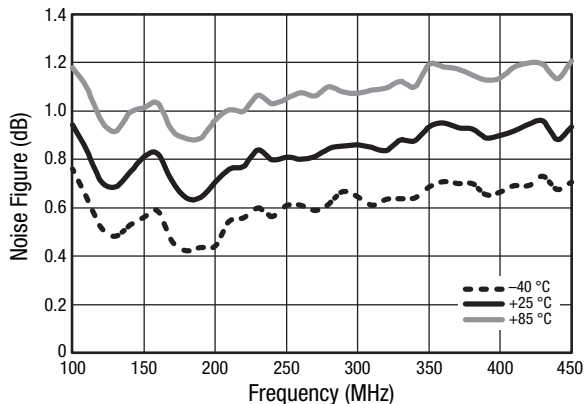

**Figure 3. Noise Figure vs Frequency and Temperature, Narrow Band (Includes EVB Insertion Losses)**

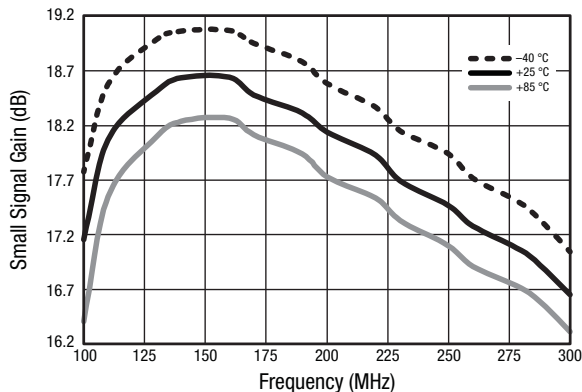

**Figure 4. Small Signal Gain (IS21) vs Frequency and Temperature, Narrow Band**

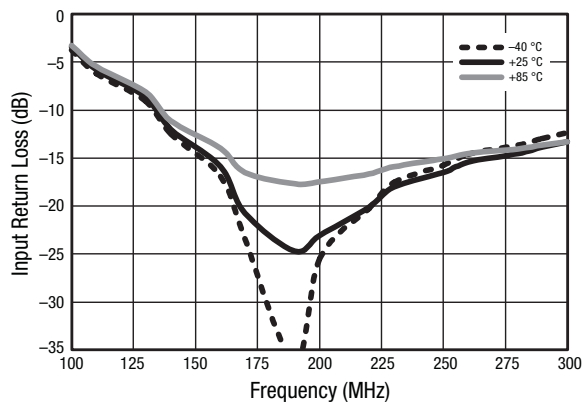

**Figure 5. Small Signal Input Return Loss (IS11) vs Frequency and Temperature, Narrow Band**

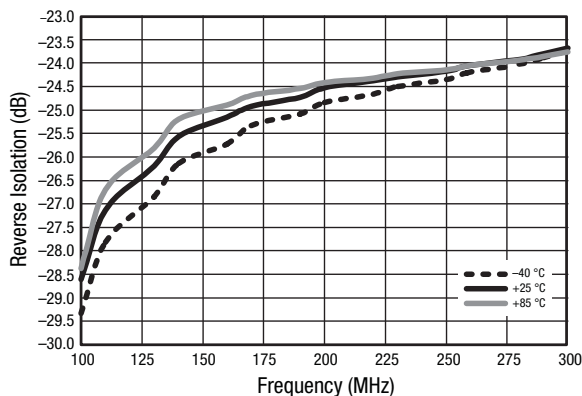

**Figure 6. Small Signal Reverse Isolation (IS12) vs Frequency and Temperature, Narrow Band**

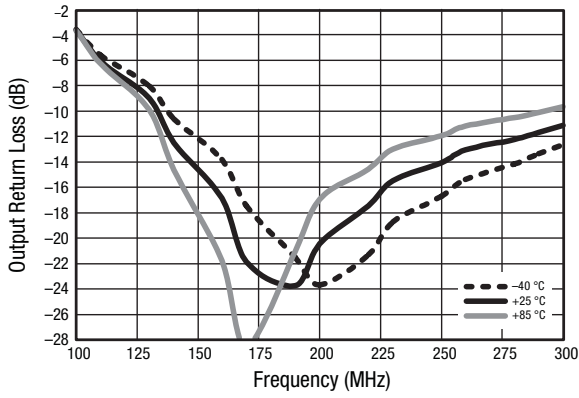

**Figure 7. Small Signal Output Return Loss (IS22) vs Frequency and Temperature, Narrow Band**

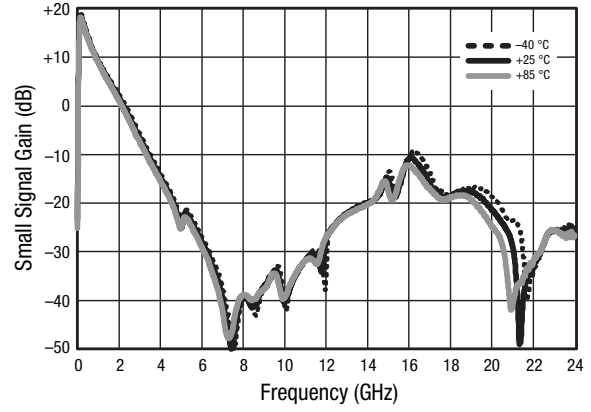

**Figure 8. Small Signal Gain (IS21) vs Frequency and Temperature, Wide Band**

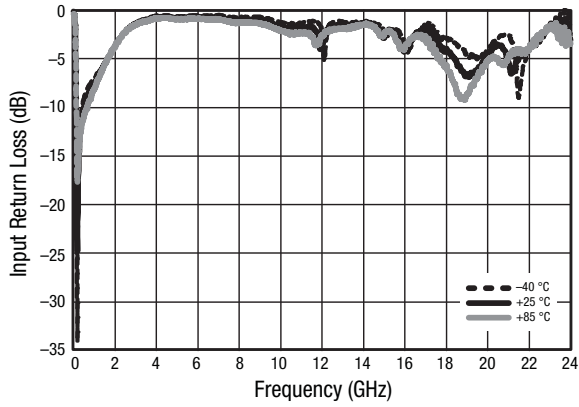

**Figure 9. Small Signal Input Return Loss (IS11) vs Frequency and Temperature, Wide Band**

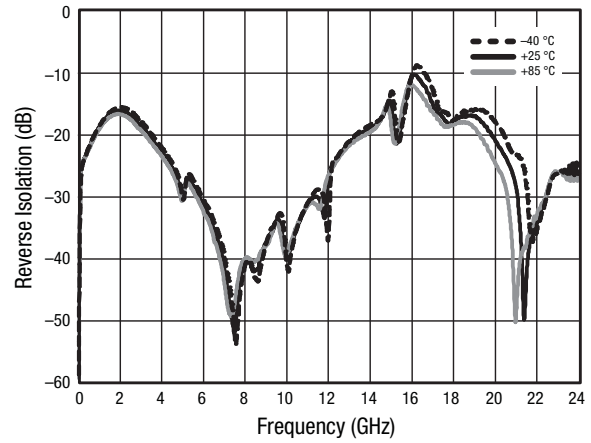

**Figure 10. Small Signal Reverse Isolation (IS12) vs Frequency and Temperature, Wide Band**

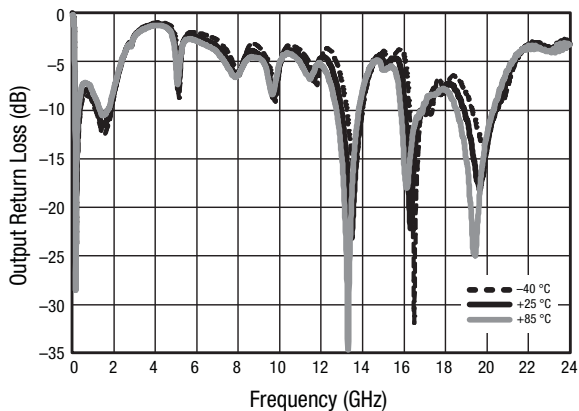

Figure 11. Small Signal Output Return Loss (S22) vs Frequency and Temperature, Wide Band

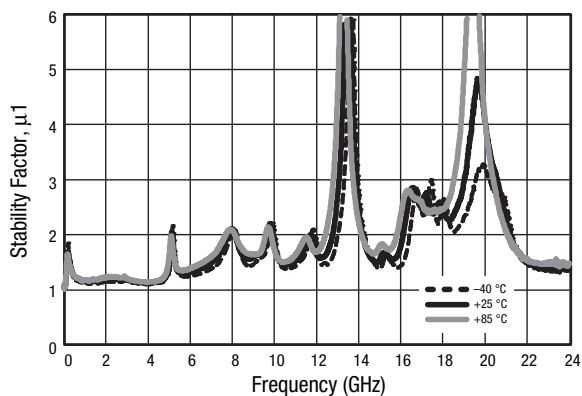

Figure 12. Stability Factor ( $\mu_1$ ) vs Frequency and Temperature, Wide Band

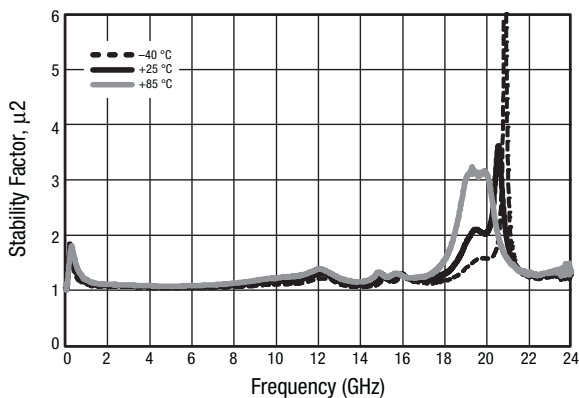

Figure 13. Stability Factor ( $\mu_2$ ) vs Frequency and Temperature, Wide Band

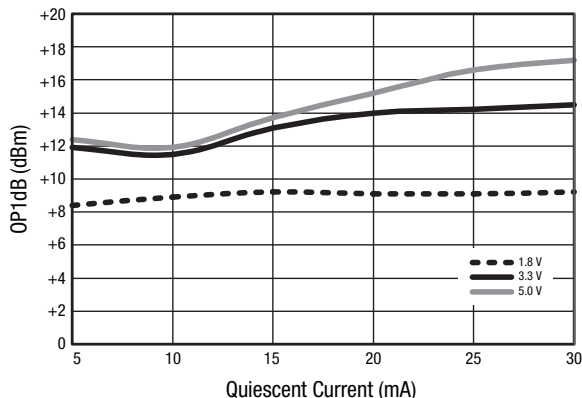

Figure 14. OP1dB vs Quiescent Current

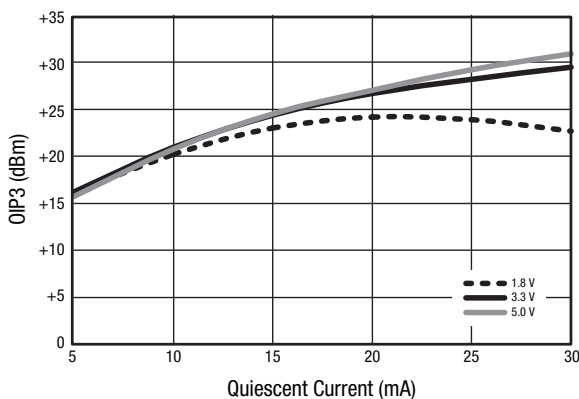

Figure 15. OIP3 vs Quiescent Current

### Evaluation Board Description

The SKY67015-396LF Evaluation Board is used to test the performance of the SKY67015-396LF LNA. An assembly drawing for the Evaluation Board is shown in Figure 16. An Evaluation Board schematic diagram is provided in Figure 17. Table 5 provides the Bill of Materials (BOM) list for Evaluation Board components.

### Package Dimensions

The PCB layout footprint for the SKY67015-396LF is provided in Figure 18. Typical case markings are shown in Figure 19. Package dimensions for the 8-pin DFN are shown in Figure 20, and tape and reel dimensions are provided in Figure 21.

### Package and Handling Information

Instructions on the shipping container label regarding exposure to moisture after the container seal is broken must be followed. Otherwise, problems related to moisture absorption may occur when the part is subjected to high temperature during solder assembly.

The SKY67015-396LF is rated to Moisture Sensitivity Level 1 (MSL1) at 260 °C. It can be used for lead or lead-free soldering. For additional information, refer to the Skyworks Application Note, *Solder Reflow Information*, document number 200164.

Care must be taken when attaching this product, whether it is done manually or in a production solder reflow environment. Production quantities of this product are shipped in a standard tape and reel format.

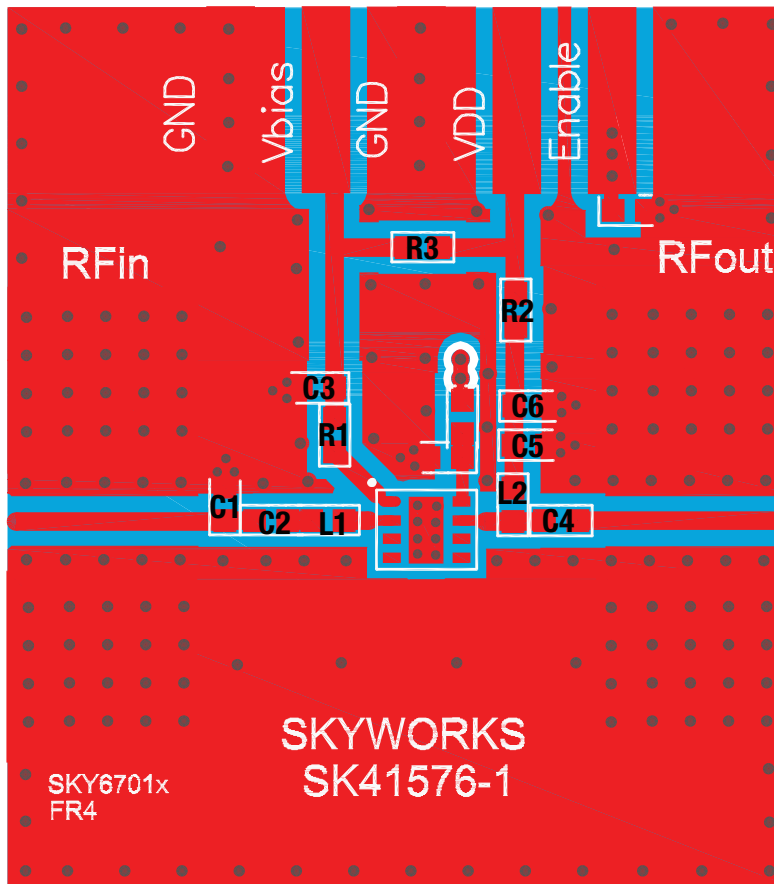

S2394

Figure 16. SKY67015-396LF Evaluation Board Assembly Diagram

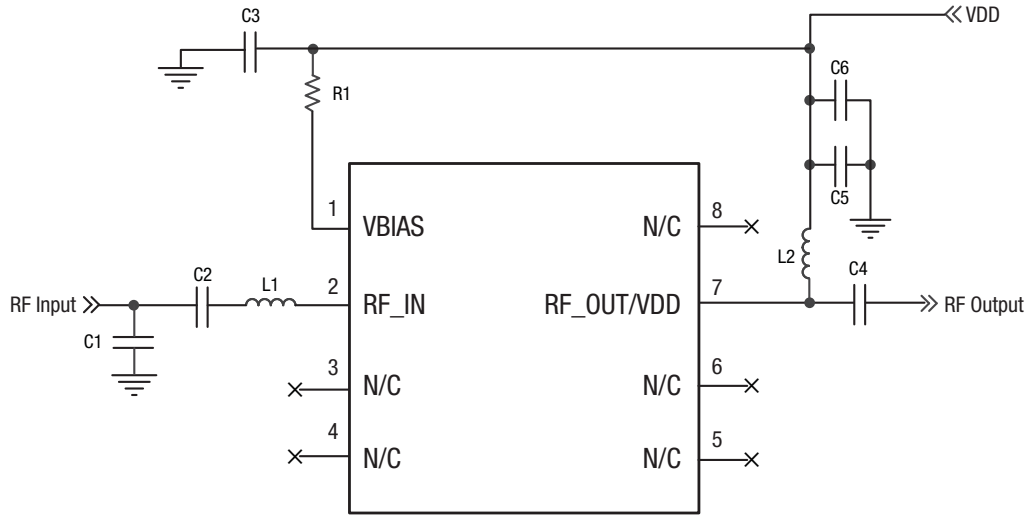

S2397

Figure 17. SKY67015-396LF Evaluation Board Schematic

Table 5. SKY67015-396LF Evaluation Board Bill of Materials

Component	Value	Size	Manufacturer	Part Number
C1	DNI	–	–	–
C2, C3	1000 pF	0402	Murata	GRM1555C1H102JA01D
C4	15 pF	0402	Murata	GRM1555C1H150JZ01D
C5	100 pF	0402	Murata	GRM1555C1H101JZ01D
C6	10000 pF	0402	Murata	GRM155R71H103KA88
L1	12 nH	0402	Coilcraft	0402HP-12NX_L
L2	82 nH	0402	Murata	LQG15HS82NJ02D
R1 (Note 1)	4.7 kΩ	0402	Panasonic	ERJ-2GEJ472X

Note 1: Components R2 and R3 shown on the Evaluation Board are 0 Ω jumpers and are not required.

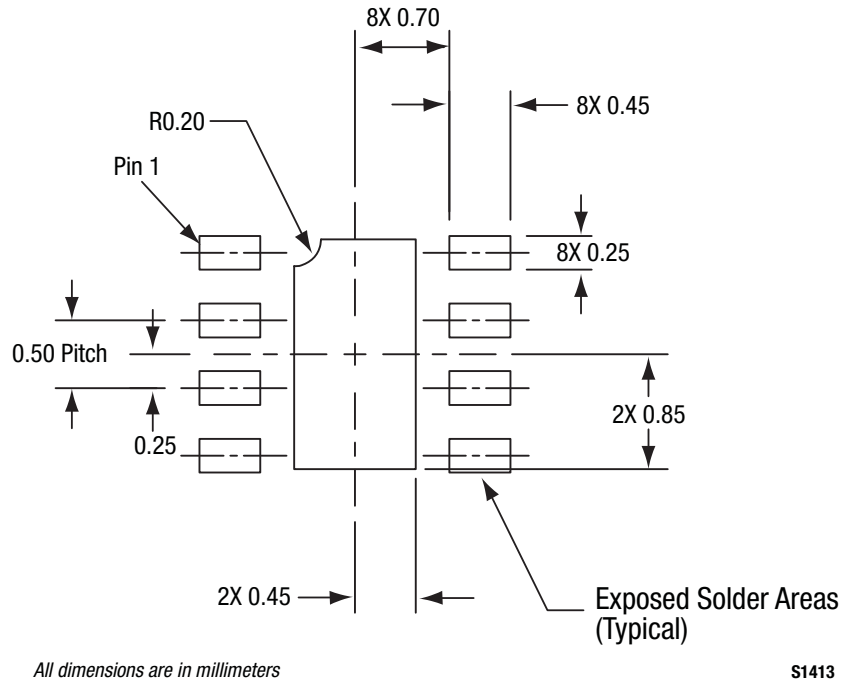

S1413

**Figure 18. SKY67015-396LF PCB Layout Footprint (Top View)**

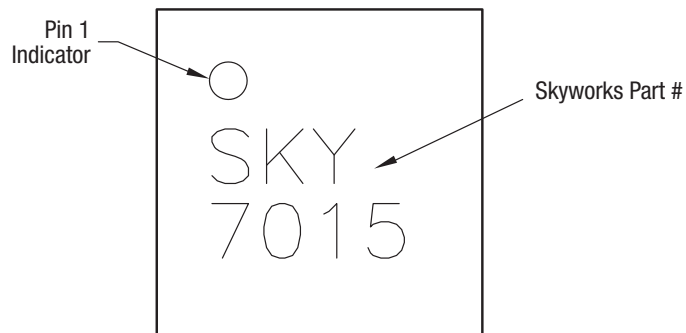

**Figure 19. Typical Case Markings (Top View)**

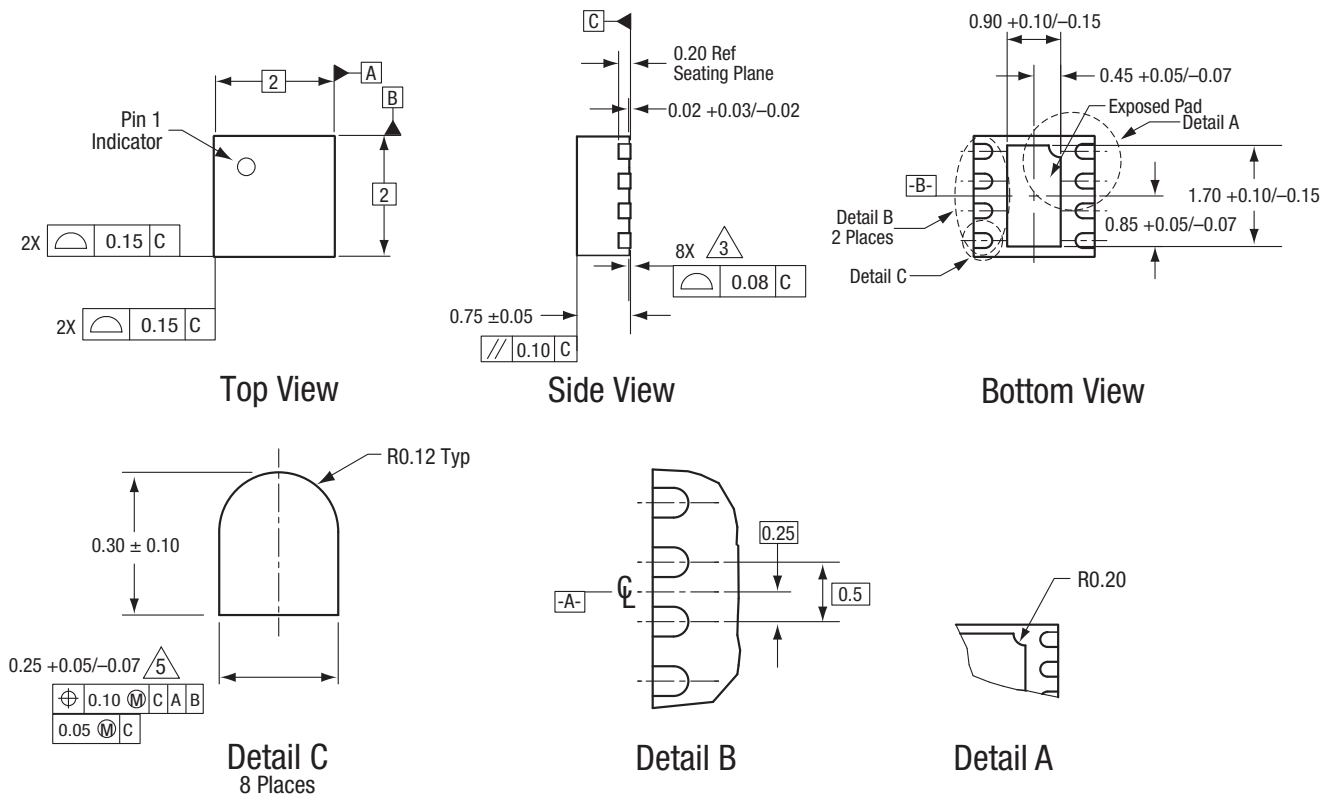

All measurements are in millimeters.  
 Dimensioning and tolerancing according to ASME Y14.5M-1994.  
 Coplanarity applies to the exposed heat sink slug as well as the terminals..  
 Plating requirement per source control drawing (SCD) 2504.  
 Dimension applies to metalized terminal and is measured between 0.15 mm and 0.30 mm from terminal tip.

S1945

Figure 20. SKY67015-396LF 8-Pin DFN Package Dimensions

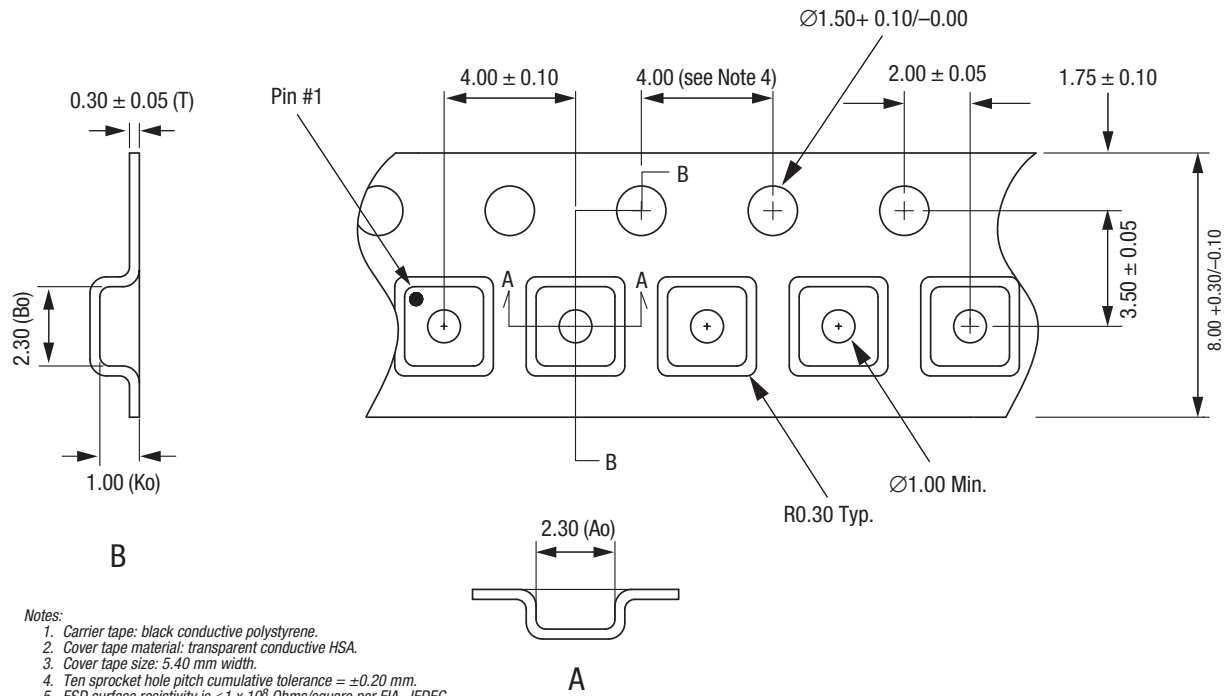

- Notes:
1. Carrier tape: black conductive polystyrene.
  2. Cover tape material: transparent conductive HSA.
  3. Cover tape size: 5.40 mm width.
  4. Ten sprocket hole pitch cumulative tolerance =  $\pm 0.20$  mm.
  5. ESD surface resistivity is  $\leq 1 \times 10^9$  Ohms/square per EIA, JEDEC tape and reel specification.
  6. Ao and Bo measurement point to be 0.30 mm from bottom pocket.
  7. All measurements are in millimeters.

S1601

Figure 21. SKY67015-396LF Tape and Reel Dimensions

## Ordering Information

Model Name	Manufacturing Part Number	Evaluation Board Part Number
SKY67015-396LF: Low-Noise, Low-Current Amplifier	SKY67015-396LF	SKY67015-396LF-EVB

Copyright © 2012-2014 Skyworks Solutions, Inc. All Rights Reserved.

Information in this document is provided in connection with Skyworks Solutions, Inc. (“Skyworks”) products or services. These materials, including the information contained herein, are provided by Skyworks as a service to its customers and may be used for informational purposes only by the customer. Skyworks assumes no responsibility for errors or omissions in these materials or the information contained herein. Skyworks may change its documentation, products, services, specifications or product descriptions at any time, without notice. Skyworks makes no commitment to update the materials or information and shall have no responsibility whatsoever for conflicts, incompatibilities, or other difficulties arising from any future changes.

No license, whether express, implied, by estoppel or otherwise, is granted to any intellectual property rights by this document. Skyworks assumes no liability for any materials, products or information provided hereunder, including the sale, distribution, reproduction or use of Skyworks products, information or materials, except as may be provided in Skyworks Terms and Conditions of Sale.

THE MATERIALS, PRODUCTS AND INFORMATION ARE PROVIDED “AS IS” WITHOUT WARRANTY OF ANY KIND, WHETHER EXPRESS, IMPLIED, STATUTORY, OR OTHERWISE, INCLUDING FITNESS FOR A PARTICULAR PURPOSE OR USE, MERCHANTABILITY, PERFORMANCE, QUALITY OR NON-INFRINGEMENT OF ANY INTELLECTUAL PROPERTY RIGHT; ALL SUCH WARRANTIES ARE HEREBY EXPRESSLY DISCLAIMED. SKYWORKS DOES NOT WARRANT THE ACCURACY OR COMPLETENESS OF THE INFORMATION, TEXT, GRAPHICS OR OTHER ITEMS CONTAINED WITHIN THESE MATERIALS. SKYWORKS SHALL NOT BE LIABLE FOR ANY DAMAGES, INCLUDING BUT NOT LIMITED TO ANY SPECIAL, INDIRECT, INCIDENTAL, STATUTORY, OR CONSEQUENTIAL DAMAGES, INCLUDING WITHOUT LIMITATION, LOST REVENUES OR LOST PROFITS THAT MAY RESULT FROM THE USE OF THE MATERIALS OR INFORMATION, WHETHER OR NOT THE RECIPIENT OF MATERIALS HAS BEEN ADVISED OF THE POSSIBILITY OF SUCH DAMAGE.

Skyworks products are not intended for use in medical, lifesaving or life-sustaining applications, or other equipment in which the failure of the Skyworks products could lead to personal injury, death, physical or environmental damage. Skyworks customers using or selling Skyworks products for use in such applications do so at their own risk and agree to fully indemnify Skyworks for any damages resulting from such improper use or sale.

Customers are responsible for their products and applications using Skyworks products, which may deviate from published specifications as a result of design defects, errors, or operation of products outside of published parameters or design specifications. Customers should include design and operating safeguards to minimize these and other risks. Skyworks assumes no liability for applications assistance, customer product design, or damage to any equipment resulting from the use of Skyworks products outside of stated published specifications or parameters.

Skyworks and the Skyworks symbol are trademarks or registered trademarks of Skyworks Solutions, Inc., in the United States and other countries. Third-party brands and names are for identification purposes only, and are the property of their respective owners. Additional information, including relevant terms and conditions, posted at [www.skyworksinc.com](http://www.skyworksinc.com), are incorporated by reference.

## Looking for pricing, stock, or lifecycle information?

Click below to explore more details on WIN SOURCE:

 [View SKY67015-396LF on WIN SOURCE](#)

 [Skyworks Solutions Inc. Information](#)

## Optimize Your Supply Chain with WIN SOURCE Solutions

-  Global Sourcing Solution
-  Obsolete Management
-  Cost Control Management
-  Shortage Management
-  Alternative Solution
-  Excess Inventory Management