



THE DATASHEET OF SR4C033-R



Latona Antenna for LP-WAN applications

Part No. SR4C033-L SR4C033-R

lamiiANT[®]

Product Specification

1. Features

- Antenna for LP-WAN applications. Including NB-IOT, LoRa, SigFox, ISM and Weightless-P
- Frequency bands from 791- 960MHz
- Maintains high performance on device: DFI (Designed for Integration)
- Corner placement to save space
- Low profile innovative design.
- SMD mounting
- Supplied on Tape and Reel
- Automotive temperature rating.

2. Description

Latona uses a ground plane on the host PCB to radiate effectively. The antenna itself requires a clearance underneath. An external matching circuit is used to optimise the antenna within a device to the required bands. Designed specifically for LP-WAN applications that require a small robust solution. Latona comes in Left and Right hand versions to optimise placement.

3. Applications

- Remote monitoring/ Smart meters
- Network Devices
- Smart Buildings
- Smart cities
- Manufacturing automation
- Agriculture/Environment
- Consumer tracking



4. Part Number

Latona Left: SR4C033-L



Latona Right: SR4C033-R



5. General Data

Product name	Latona
Part Number	SR4C033
Frequency	791 – 960MHz
Polarization	Linear
Operating temperature	-40°C to140°C
Environmental Condition Test	ISO16750-4 5.1.1.1/5.1.2.1/5.3.2
Impedance with matching	50 Ω
Weight	< 2g
Antenna type	SMD
Dimensions	20.0 x 11.0 x 1.6 (mm)

6. RF Characteristics

	791 – 862 MHz	824 – 960 MHz
Peak gain	0.5dBi	0.8dBi
Average gain (Linear)	-1.50dBi	-1.50dBi
Average efficiency	>60%	>65%
Maximum return loss	-9dB	-7dB
Maximum VSWR	2.1:1	2.6:1

All data measured on Antenna's evaluation PCB
Part No. SR4C033-EVB-1

7. RF Performance

The performance is shown for two tuned variants (Tuning dependant on required band). Matching circuit is used for band selection.

B20: 791 – 862MHz

B5 and B8: 824-894MHz; 880- 960MHz

7.1 Return Loss

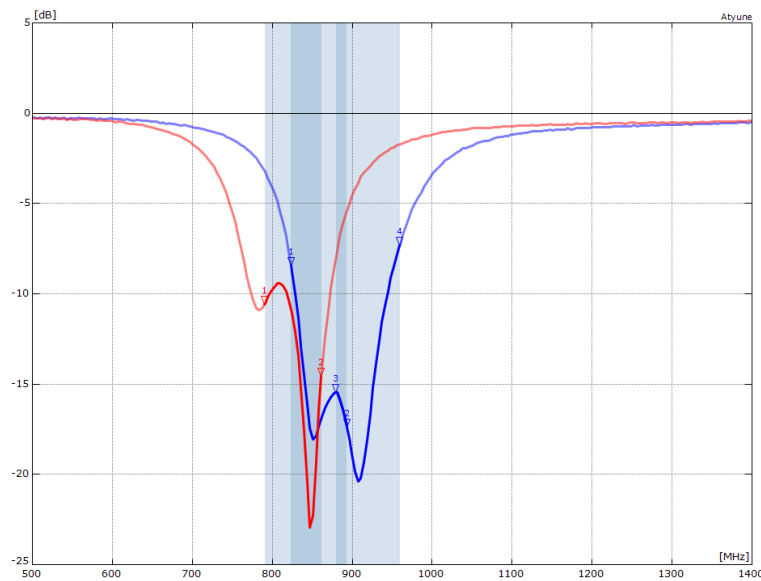

7.2 VSWR

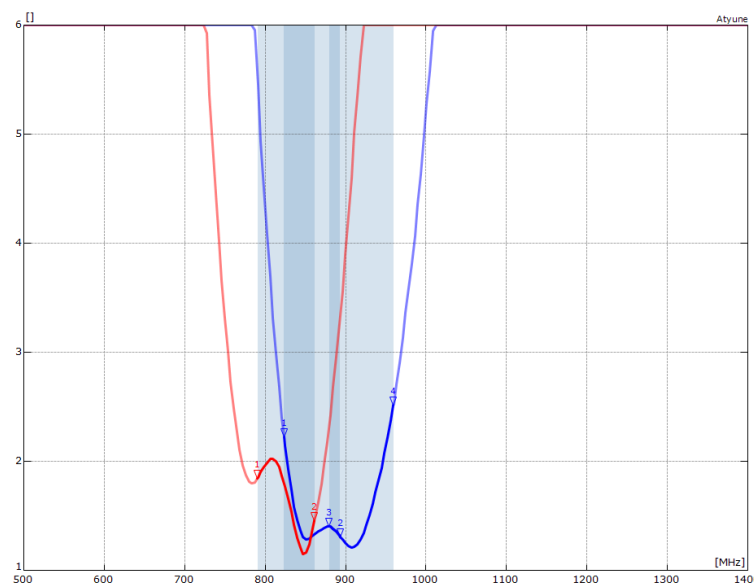

7.3 Antenna pattern

7.3.1 791 – 862 MHz

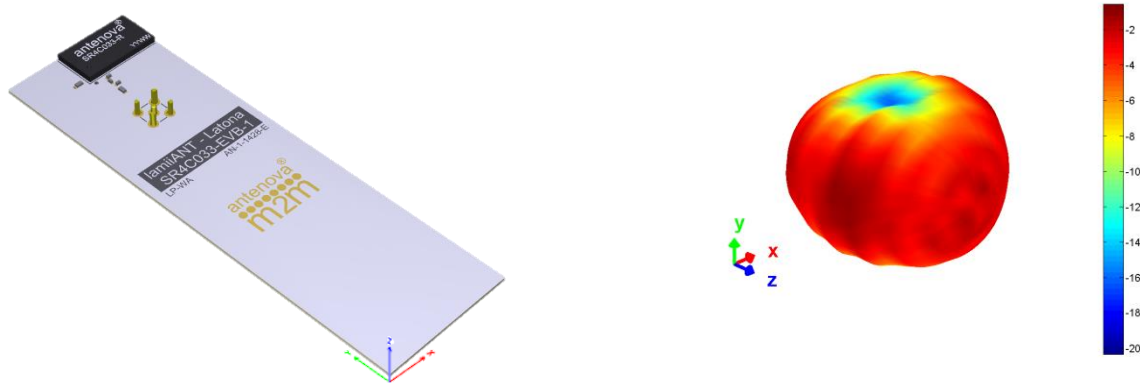

3D pattern at 830 MHz

*Drag to rotate pattern and PCB by using Adobe Reader
(Click to Activate)*

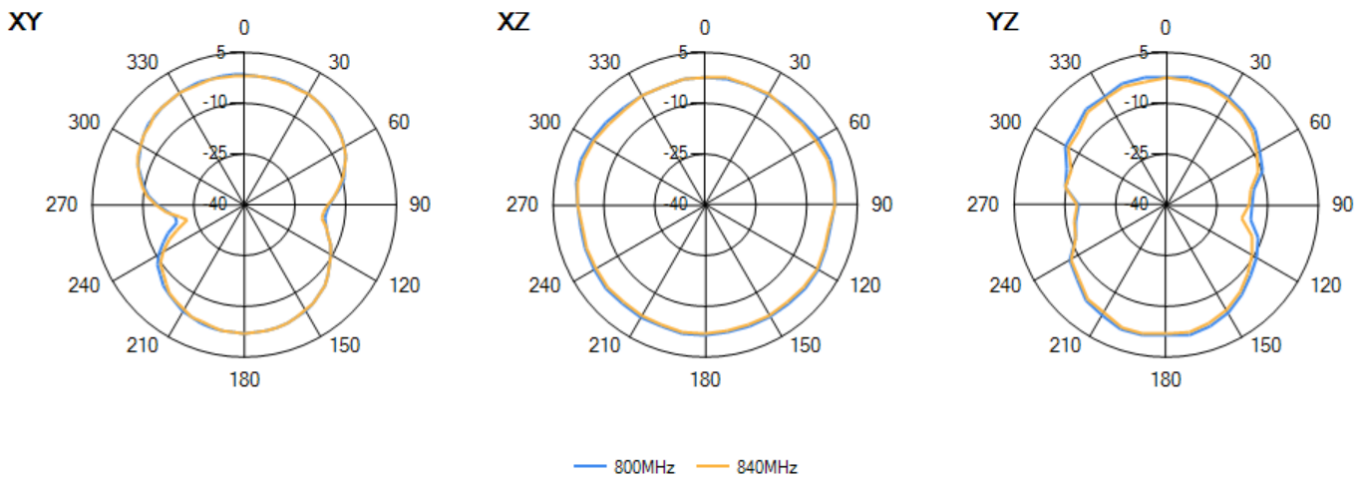

7.3.2 824 – 960 MHz

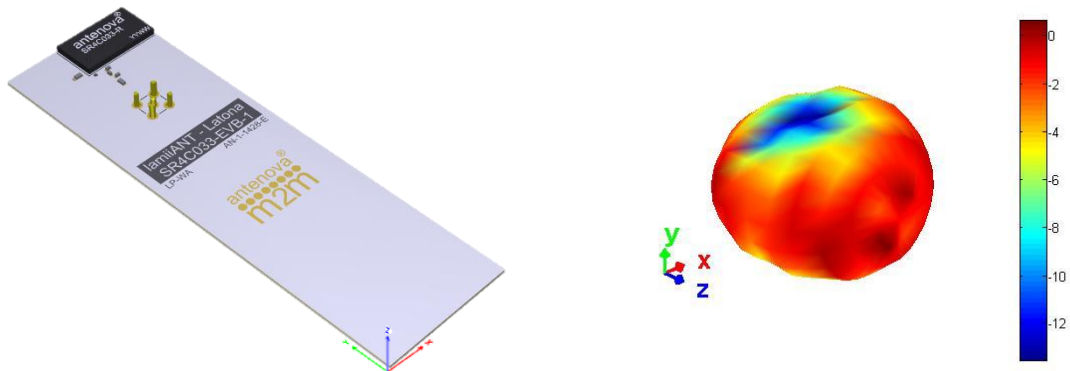

3D pattern at 880 MHz
*Drag to rotate pattern and PCB by using Adobe Reader
(Click to Activate)*

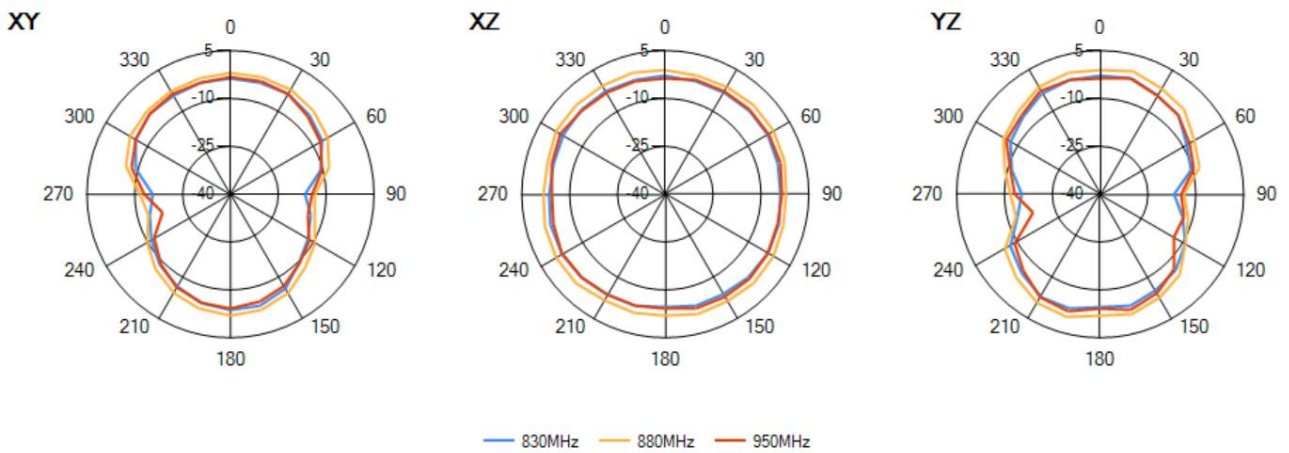

8. Antenna Dimensions

Latona Left: SR4C033-L

Latona Right: SR4C033-R



Top side

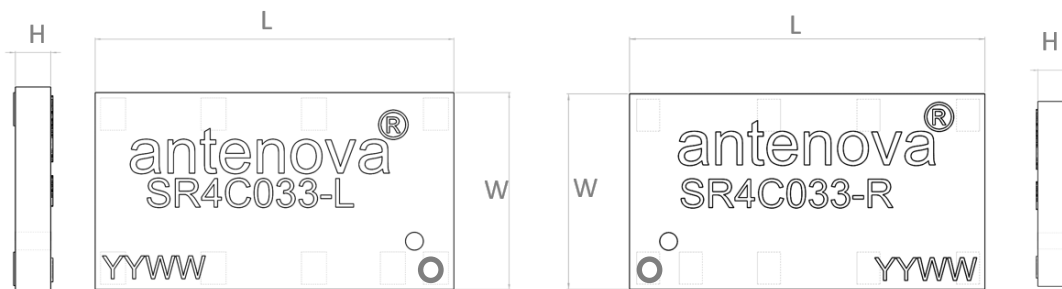

L	W	H
Length	Width	Height
20.0 ±0.1	11.0 ±0.1	1.6 ±0.1

All Dimensions in (mm)

Bottom Side

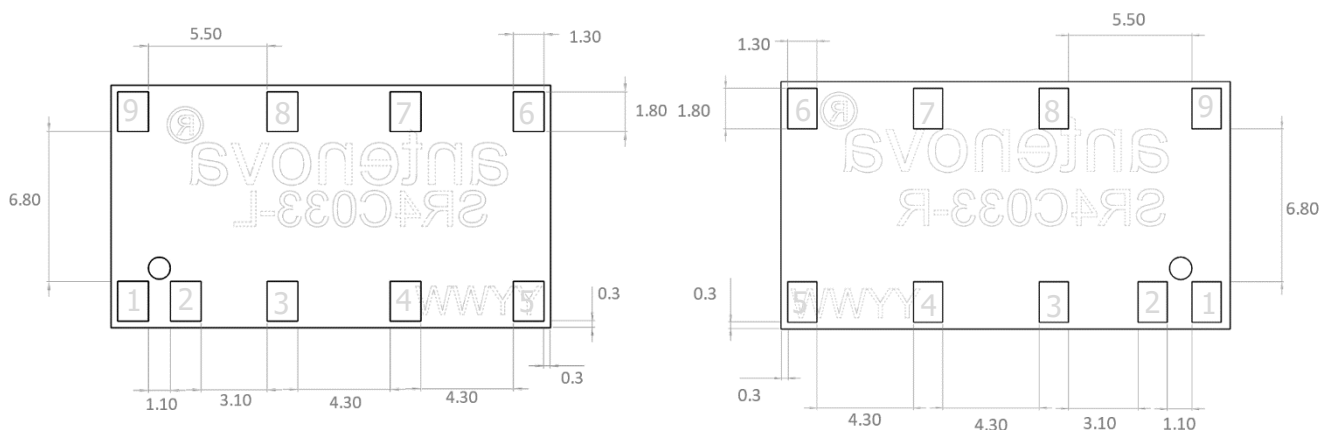

All Dimensions in (mm)

Antennas for Wireless M2M Applications

9.0 Schematic symbol and Pin definition

The circuit symbol for the antenna is shown below. The antenna has 9 pins with only two as functional. All other pins are for mechanical strength.

Pin	Description
2	Feed
1	Band Select (B.SEL)
3,4,5,6,7,8,9	Not used (Mechanical only)



10.0 Antenna footprint

The recommended host PCB footprint is below.

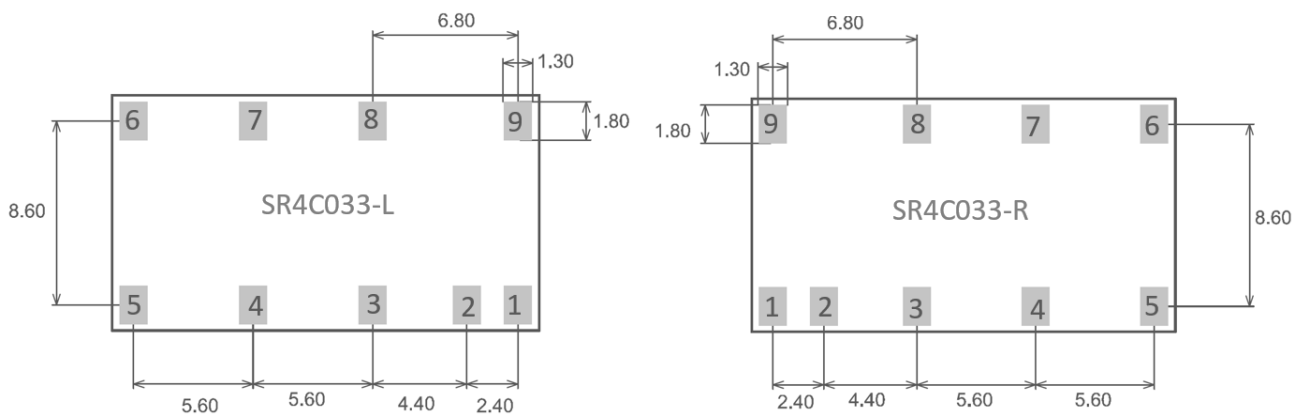

9 copper pads all 1.8 x 1.3 (mm)
All Dimensions in mm

11. Electrical Interface

11.1 Transmission Line

All transmission lines should be designed to have a characteristic impedance of 50Ω.

- The length of the transmission lines should be kept to a minimum.
- Any other parts of the RF system like transceivers, power amplifiers, etc, should also be designed to have an impedance of 50 Ω.

Once the material for the PCB has been chosen (PCB thickness and dielectric constant), a coplanar transmission line can easily be designed using any of the commercial software packages for transmission line design. For the chosen PCB thickness, copper thickness and substrate dielectric constant, the program will calculate the appropriate transmission line width and gaps on either side of the track so the characteristic impedance of the co-planar transmission is 50 Ω.

11.2 Matching Circuit

The antenna requires a matching circuit that must be optimized for each product. The matching circuit will require up to five components and the following circuit should be designed into the host PCB. Not all components may be required but should be included as a precaution. The matching network must be placed close to the antenna feed to ensure it is more effective in tuning the antenna.

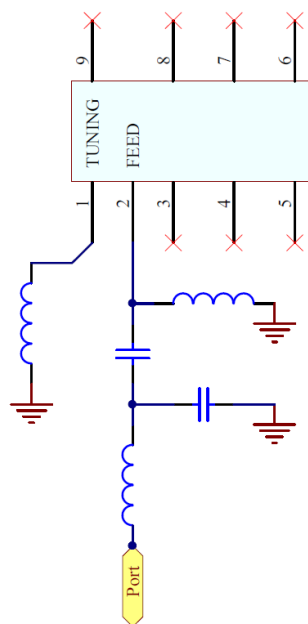

12.0 Antenna Integration Guide

12.1 Antenna Placement

Whatever the size of the host PCB, the antenna should ideally be placed on the host PCB's shortest side, in the corner. The left / right antennas are placed in the corresponding corner of the PCB: SR4C033-L (Left Corner) and SR4C033-R (Right Corner).

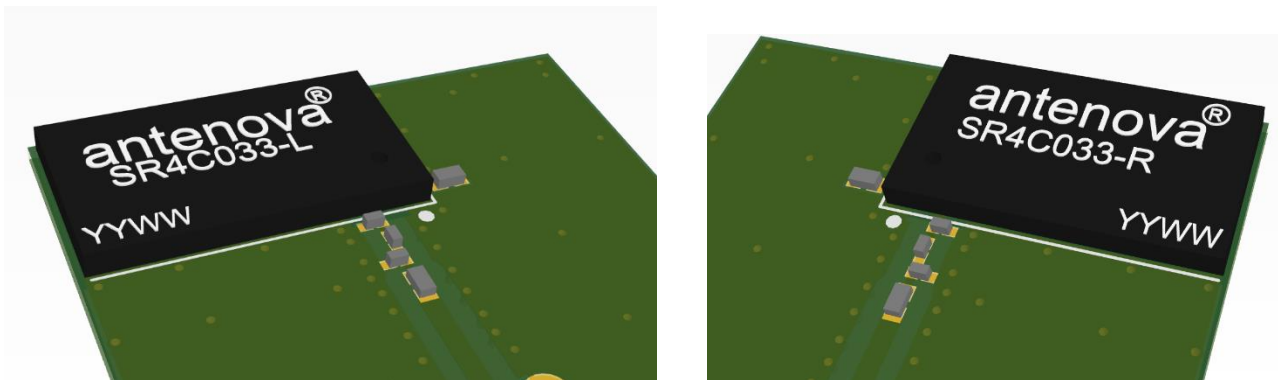

12.2 Host PCB Layout

The footprint and clearance on the host PCB must meet the antenna specification. An example of the PCB layout shows the antenna footprint with clearance. The feed (Pin 2) connects to the matching circuit close to the antenna. For Pin 1 (B.SEL) the component should be close to this pin.

Example host layout

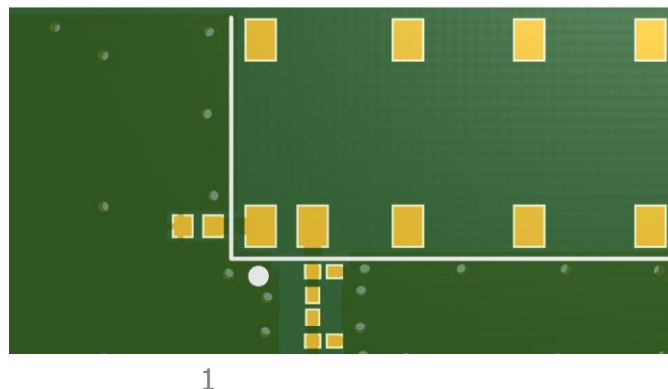

12.3 Host PCB Clearance

Below shows the antenna footprint and clearance through all layers on the PCB. Only the antenna pads and connections to feed and GND are present within this clearance area. The clearance area required is 20.0 x 11.0 (mm).

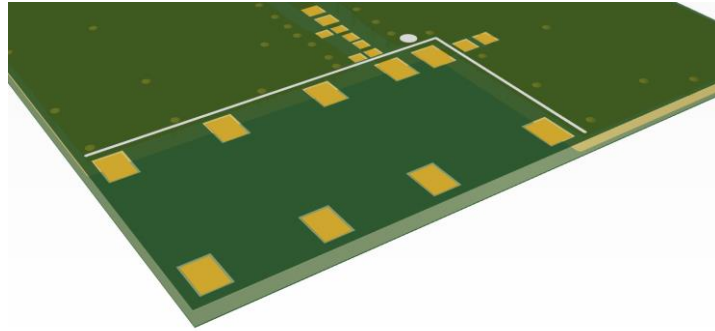

The clear-out area is simply defined as the same size as the antenna. No additional clearance is required.

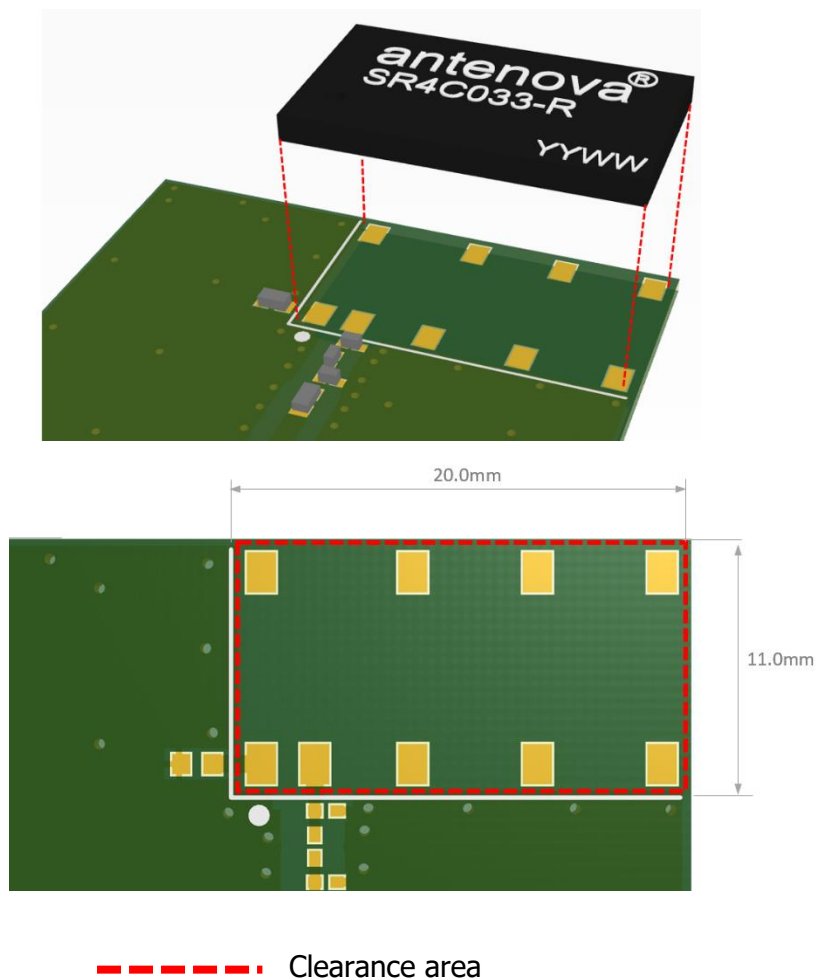

13.0 Reference Board

The reference board has been designed for evaluation purposes of SR4C033 antenna and includes a SMA female connector.

SR4C033-EVB-1 Evaluation Board
(For SR4C033-R)



SR4C033-EVB-2 Evaluation Board
(For SR4C033-L)



To order a reference board contact sales@antenna-m2m.com.
Please state if Left or Right version.

SR4C033-EVB-1 = SR4C033-R (Right)

SR4C033-EVB-2 = SR4C033-L (Left)

13.1 Reference Board Matching Circuit

The reference board has been designed for evaluation purposes of SR4C033-L and SR4C033-R and includes a SMA female connector.

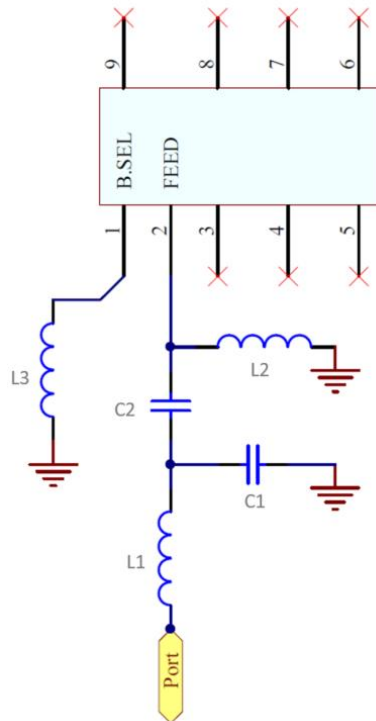

Designator	Type	Value	Description
L1	Inductor	33nH	Murata LQG15HN series
L2	Not Fitted	Not Fitted	Not Fitted
C1	Not Fitted	Not Fitted	Not Fitted
C2	Capacitor	0.5pF	Murata GRM15 series

B.SEL (Band Selection pin component)				
Frequency band	Designator	Type	Value	Description
B20	L3	Inductor	6.8nH	Murata LQG15 series
B5, B8	L3	Inductor	3.3nH	Murata LQG15 series

Band 20 = 791-862MHz

Band 5 = 880-960MHz

Band 8 = 824-894MHz

14. Soldering

This antenna is suitable for lead free soldering.

The reflow profile should be adjusted to suit the device, oven and solder paste, while observing the following conditions:

- The maximum temperature should not exceed 240 °C
- However for lead free soldering, a maximum temperature of 255 °C for no more than 20 seconds is permitted.
- The antenna should not be exposed to temperatures exceeding 120 °C more than 3 times during the soldering process.

15. Hazardous Material Regulation Conformance

The antenna has been tested to conform to RoHS requirements. A certificate of conformance is available from Antenova M2M's website.

16. Packaging

16.1 Optimal Storage Conditions

Temperature	-10°C to 40°C
Humidity	Less than 75% RH
Shelf life	24 Months
Storage place	Away from corrosive gas and direct sunlight
Packaging	Reels should be stored in unopened sealed manufacturer's plastic packaging.

Note: Storage of open reels of antennas is not recommended due to possible oxidization of pads on antennas. If short term storage is necessary, then it is highly recommended that the bag containing the antenna reel is re-sealed and stored in like storage conditions as in above table.

16.2 Tape Characteristics

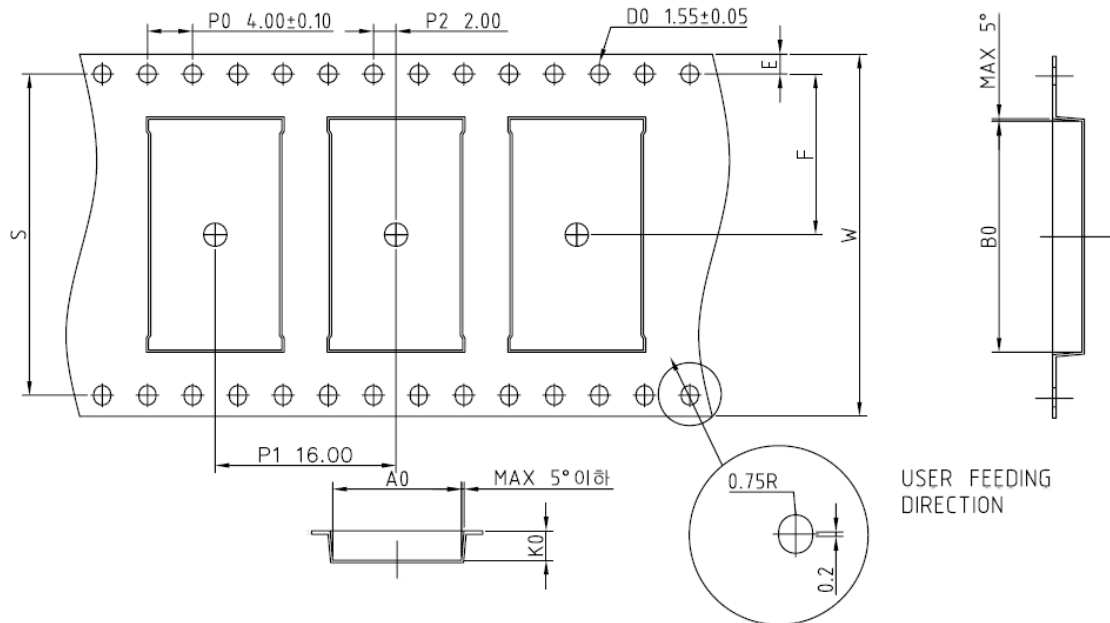

Ko	Ao	Bo	P0	P1	P2
2.80	11.40 ± 0.1	20.40 ± 0.1	4.00 ± 0.1	16.00 ± 0.1	2.00 ± 0.1

E1	F	W
1.75 ± 0.1	14.2 ± 0.15	32.00 ± 0.3

Dimensions in mm

Notes:

- 1) 10 sprocket hole pitch cumulative tolerance $\pm 0.2\text{mm}$.
- 2) Camber not to exceed 1mm in 100mm.
- 3) Ao and Bo measured on a plane 0.1mm above the bottom of the packet.
- 4) Ko measured from a plane on the inside bottom of the packet to the top surface carrier.

16.3 Reel Dimensions

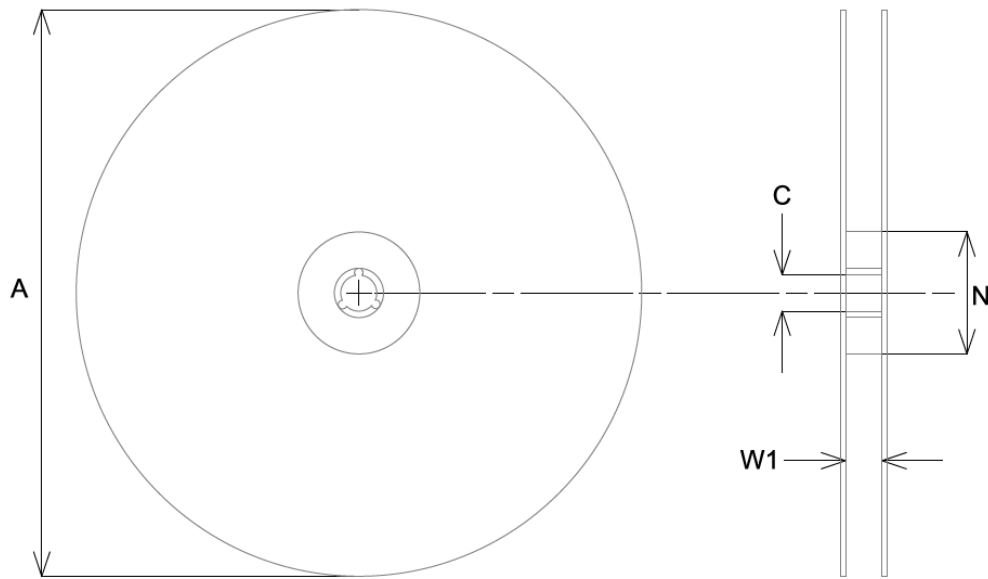

A	C	N	W1
330.0 ± 2.0	13.0 ± 0.5	80.0 ± 0.2	44.4 ± 0.3

All dimensions in mm

16.4 Box Dimensions

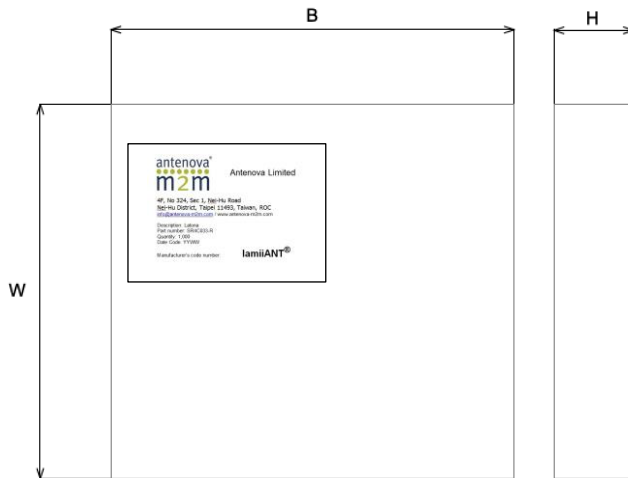

Width (W)	Breadth (B)	Thickness (H)
350mm	355mm	70mm

16.5 Bag Properties

Reels are supplied in protective plastic packaging.

16.6 Reel Label Information

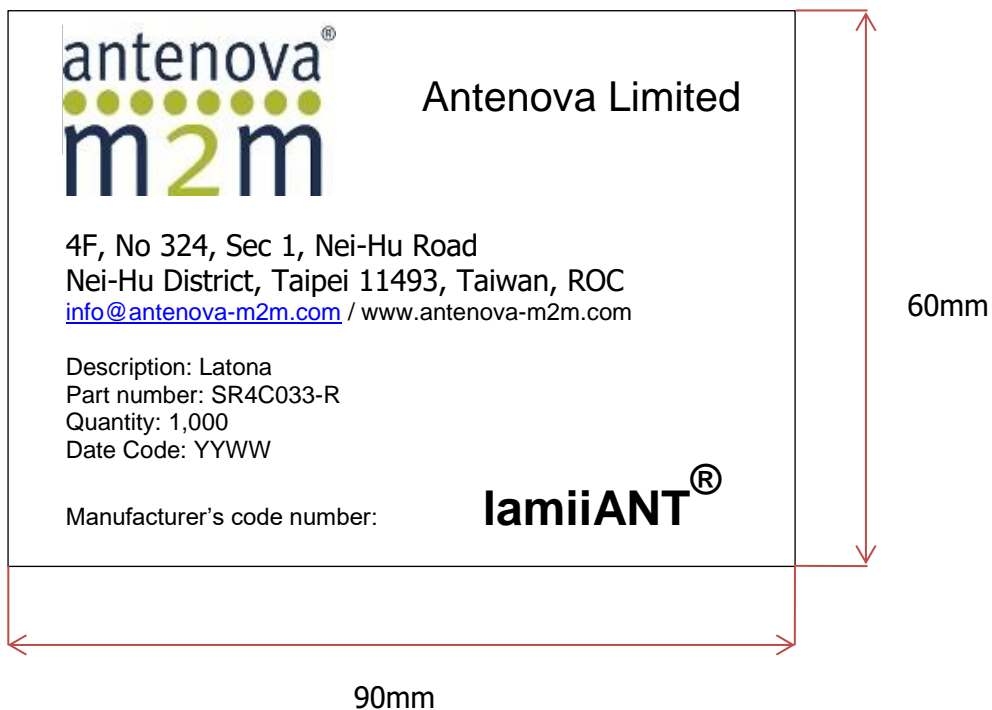



www.antenova-m2m.com

Corporate Headquarters

Antenova Limited
2nd Floor Titan Court
3 Bishop Square
Hatfield
AL10 9NA
UK

Tel: +44 1223 810600

Email: sales@antenova-m2m.com

North America Headquarters

Antenova Limited
100 Brush Creek Road
Suite 103, Santa Rosa
California 95404,
USA

Tel: +1 707 890 5202

Email: sales@antenova-m2m.com

Asia Headquarters

Antenova Asia Limited
4F, No. 324, Sec. 1, Nei-Hu Road
Nei-Hu District
Taipei 11493
Taiwan, ROC

Tel: +886 (0) 2 8797 8630

Fax: +886 (0) 2 8797 6890

Email: sales@antenova-m2m.com

Copyright© Antenova Ltd. All Rights Reserved. Antenova®, Antenova M2M®, gigaNOVA®, the Antenova product family names, and the Antenova and Antenova M2M logos are trademarks and/or registered trademarks of Antenova Ltd. Any other names and/or trademarks belong to their respective companies.



The materials provided herein are believed to be reliable and correct at the time of printing. Antenova does not warrant the accuracy or completeness of the information, text, graphics or other items contained within this information. Antenova further assumes no responsibility for the use of this information, and all such information shall be entirely at the user's risk.



Antennas for Wireless M2M Applications

Looking for pricing, stock, or lifecycle information?

Click below to explore more details on WIN SOURCE:

-  [View SR4C033-R on WIN SOURCE](#)
-  [Antenova Information](#)

Optimize Your Supply Chain with WIN SOURCE Solutions

-  Global Sourcing Solution
-  Obsolete Management
-  Cost Control Management
-  Shortage Management
-  Alternative Solution
-  Excess Inventory Management