



**THE DATASHEET OF
SGGP.12.4.A.02**





TAOGLAS®



Datasheet

12mm GPS/GLONASS/GALILEO SMT Mount Ceramic Patch Antenna

Part No:
SGGP.12.4.A.02

Features:

- 1575.42 /1602 MHz GPS/GLONASS Antenna
- 2.67 dBi Peak Gain for GPS/GALILEO Band
- 2.94 dBi Peak Gain for GLONASS Band
- 12 x 12 x 4mm dimension
- SMT direct mount ceramic patch antenna
- Automotive TS16949 Production and Quality Approved
- RoHS Compliant

1.	Introduction	2
2.	Specification	3
3.	Antenna Characteristics	4
4.	Radiation Patterns	6
5.	Mechanical Drawing	9
6.	Antenna Integration Guide	10
7.	Solder Reflow Profile	14
8.	Packaging	15
<hr/>		
	Changelog	16

Taoglas makes no warranties based on the accuracy or completeness of the contents of this document and reserves the right to make changes to specifications and product descriptions at any time without notice. Taoglas reserves all rights to this document and the information contained herein. Reproduction, use or disclosure to third parties without express permission is strictly prohibited.



1. Introduction



The SGGP.12.4.A.02 is a ceramic GPS/GLONASS/GALILEO passive patch antenna with low-profile thickness of 4mm. It is designed for applications in navigation devices, vehicle tracking/fleet management systems, and telematics devices. Typical applicable industries are transportation, defense, marine, agriculture, and navigation.

The antenna has been tuned on a 50 x 50 mm ground plane, working at 1575.42MHz and 1602MHz, with a 2.67 dBi gain and 2.94 dBi gain, respectively. The ceramic patch is mounted via SMT process. It is manufactured and tested in a TS16949 first tier automotive approved facility.

For customer specific device environments, custom tuned patch antennas are highly recommended, subject to potential NRE and MOQ. Contact your regional Taoglas sales office for details.

2. Specification

GNSS Frequency Bands					
GPS	L1 1575.42 MHz	L2 1227.6 MHz	L5 1176.45 MHz		
	■	□	□		
GLONASS	G1 1602 MHz	G2 1248 MHz	G3 1207 MHz		
	■	□	□		
Galileo	E1 1575.24 MHz	E5a 1176.45 MHz	E5b 1201.5 MHz	E6 1278.75 MHz	
	■	□	□	□	
BeiDou	B1C 1575.42 MHz	B1I 1561 MHz	B2a 1176.45 MHz	B2b 1207.14 MHz	B3 1268.52 MHz
	■	□	□	□	□
QZSS (Regional)	L1 1575.42 MHz	L2C 1227.6 MHz	L5 1176.45 MHz	L6 1278.75e6	
	■	□	□	□	
IRNSS (Regional)	L5 1176.45 MHz				
	□				
SBAS	L1/E1/B1 1575.42 MHz	L5/B2a/E5a 1176.45 MHz	G1 1602 MHz	G2 1248 MHz	G3 1207 MHz
	■	□	■	□	□

GNSS Electrical		
Frequency (MHz)	1575.42	1602
VSWR (max.)	2.0:1	2.0:1
Passive Antenna Efficiency (%) (Without cable loss)	65.69	43.15
Passive Antenna Gain at Zenith (dBi) (Without cable loss)	2.96	1.77
Polarization	RHCP	
Impedance	50 Ω	
Mechanical		
Ceramic Dimension (mm)	12 x 12 x 4	
Weight (g)	3.3	
Environmental		
Operation Temperature	-40°C to 85°C	
Humidity	Non-condensing 65°C 95% RH	
Moisture Sensitivity Level (MSL)	3 (168 Hours)	

3. Antenna Characteristics

3.1 Return Loss

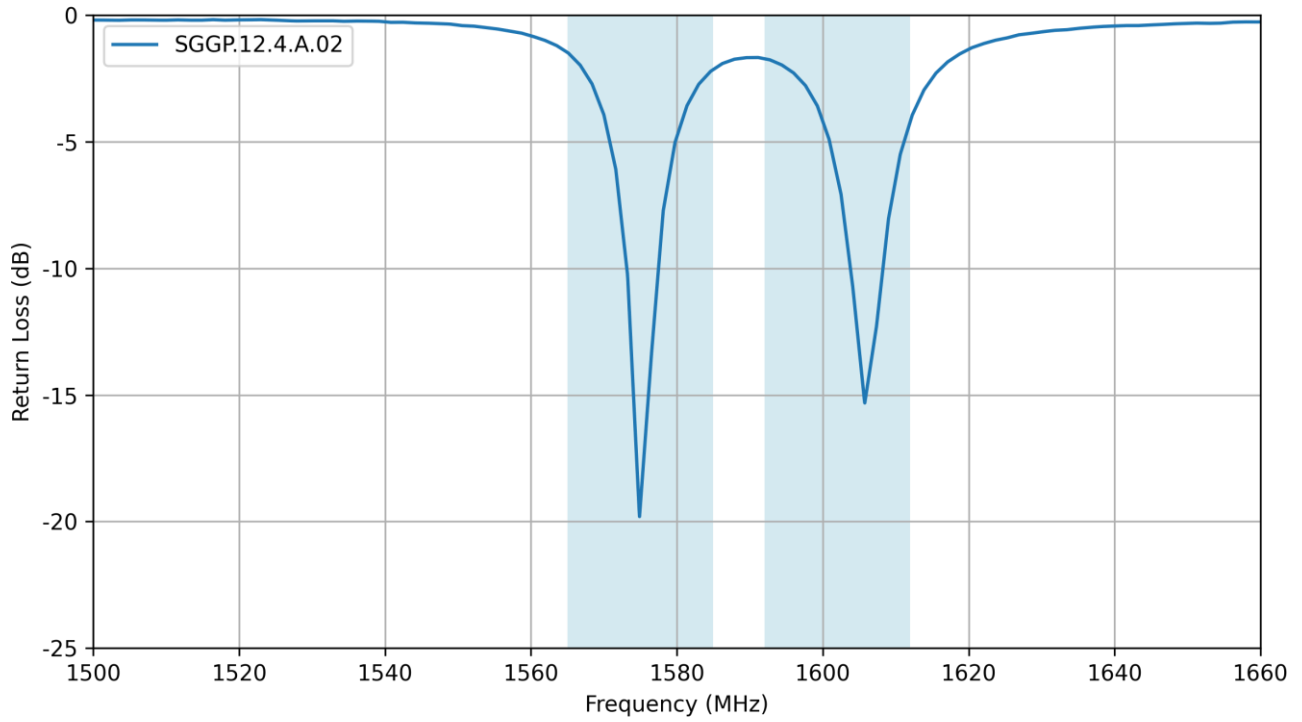

3.2 Efficiency

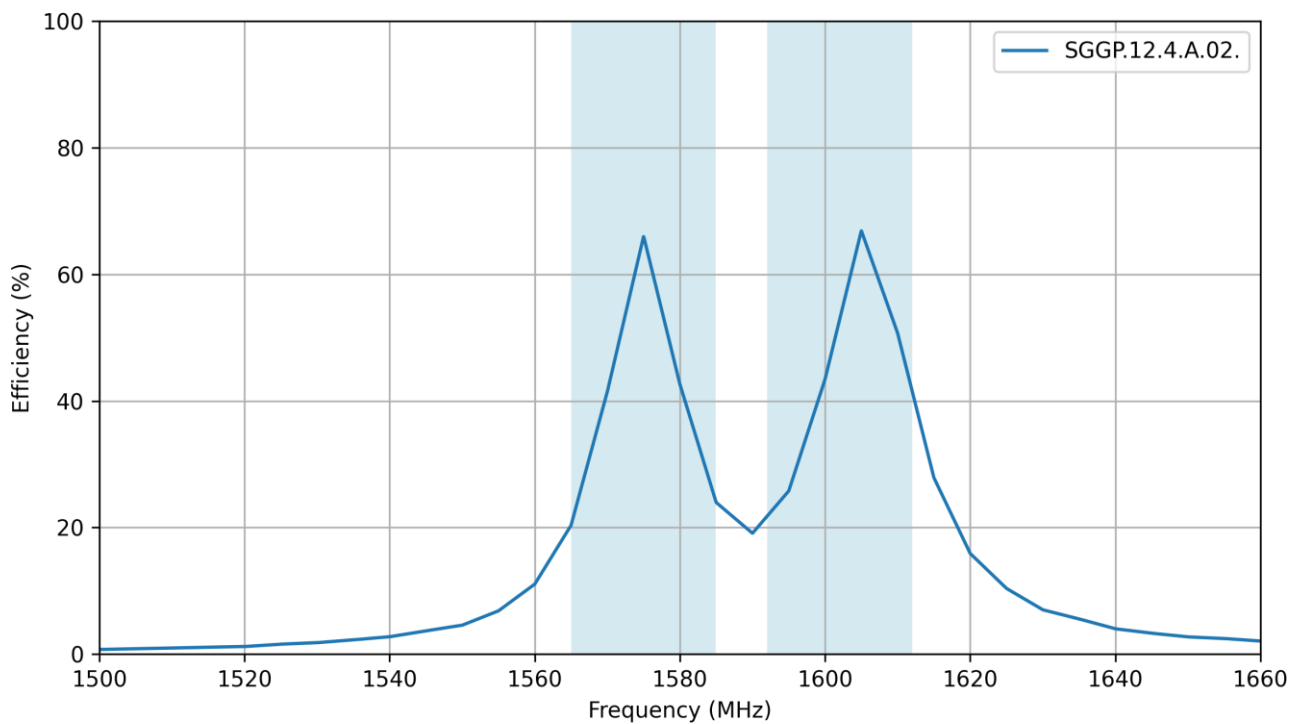

3.3 Average Gain

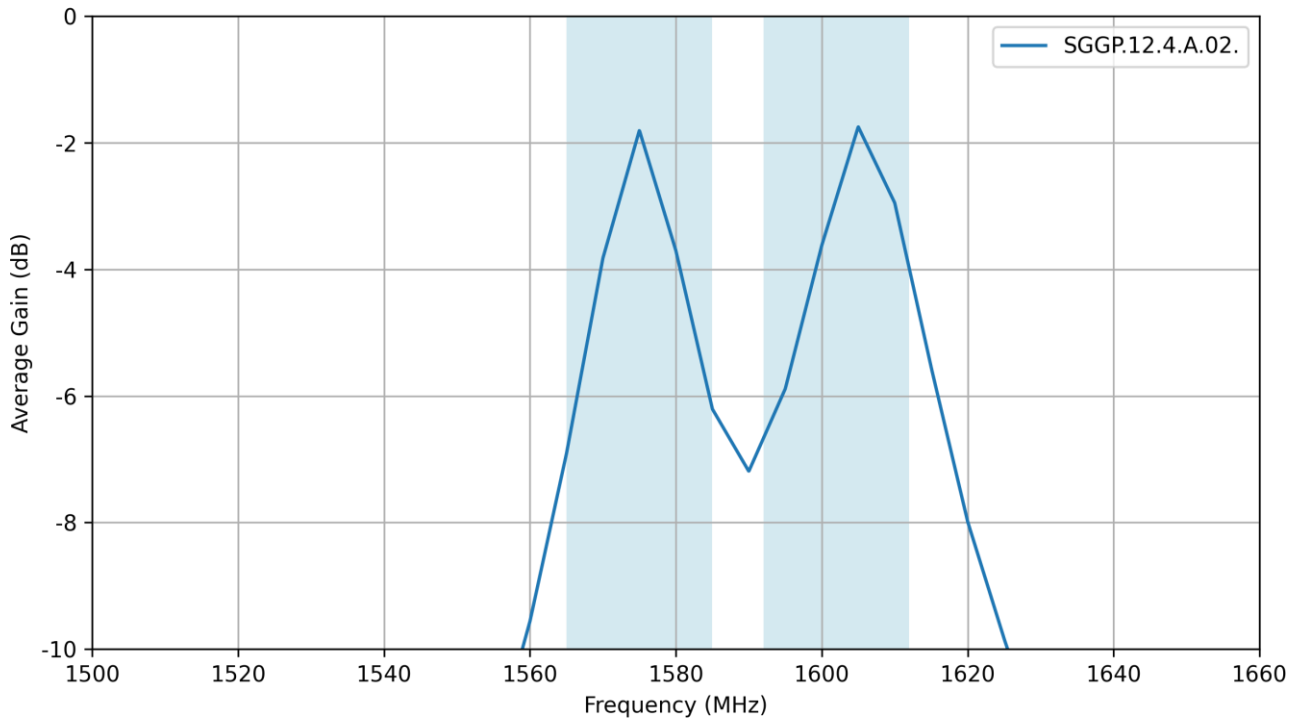

3.4 Peak Gain

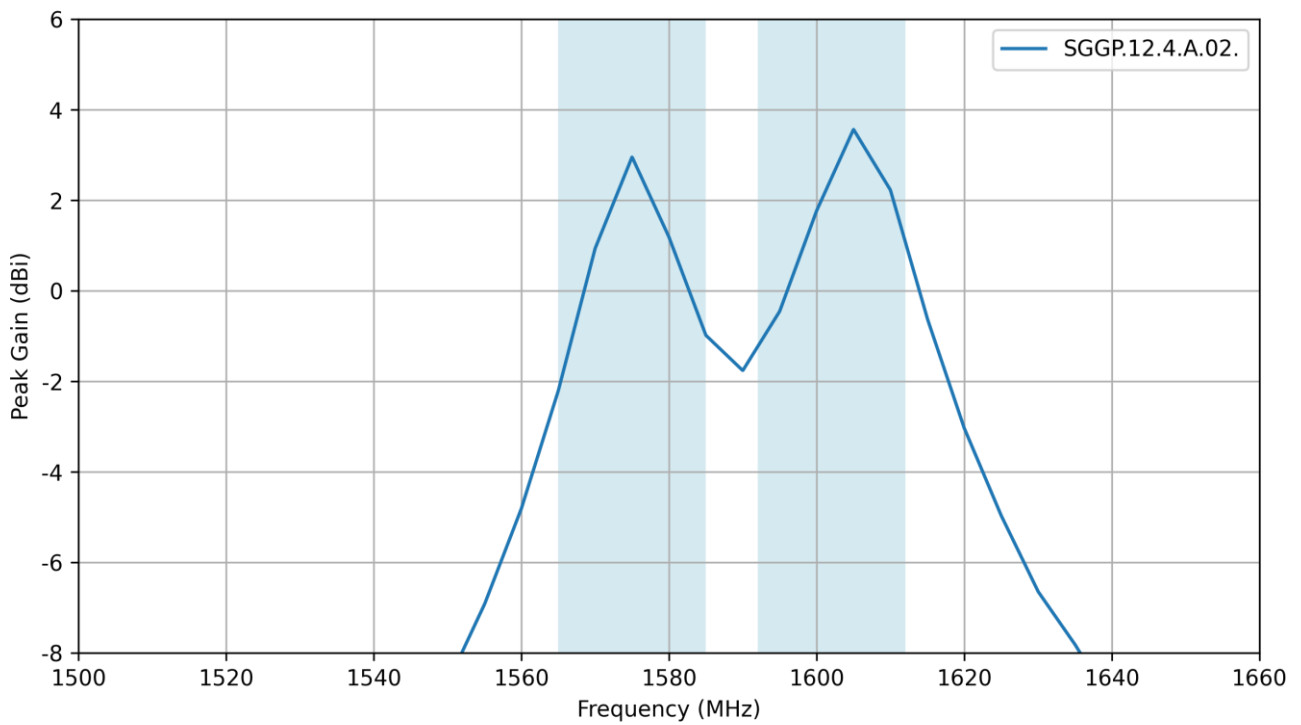

4. Radiation Patterns

4.1 Test Setup

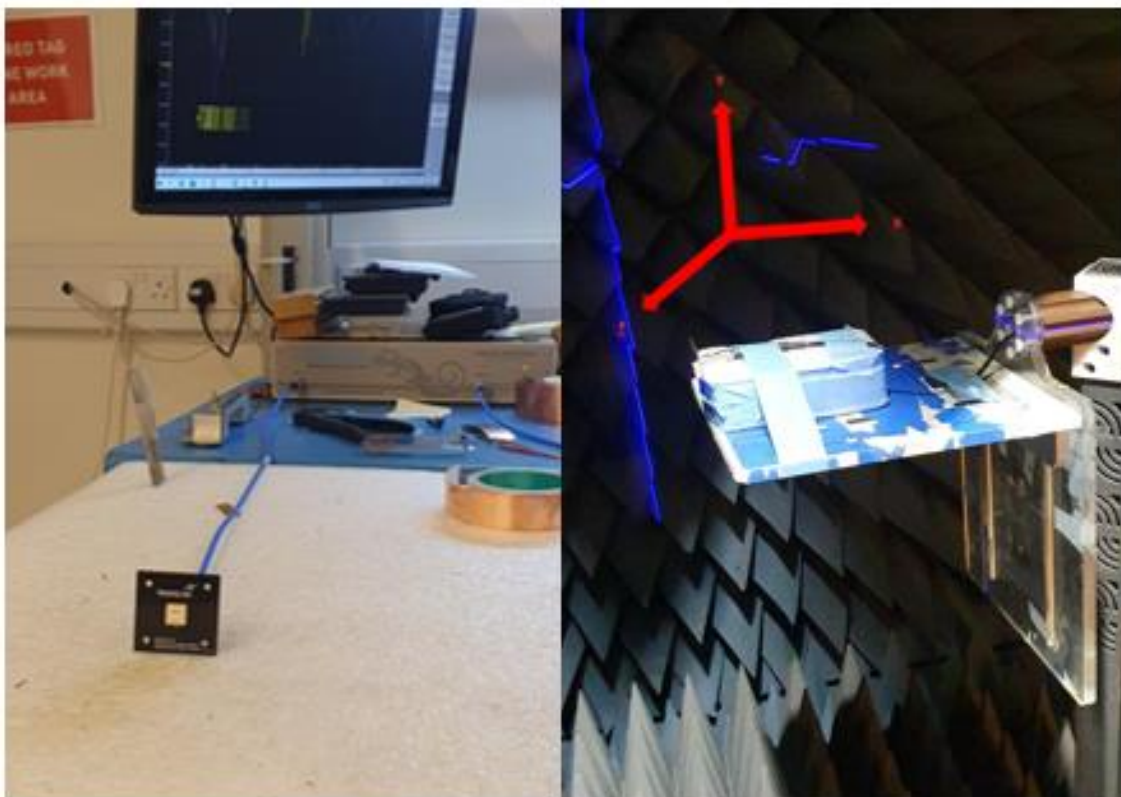
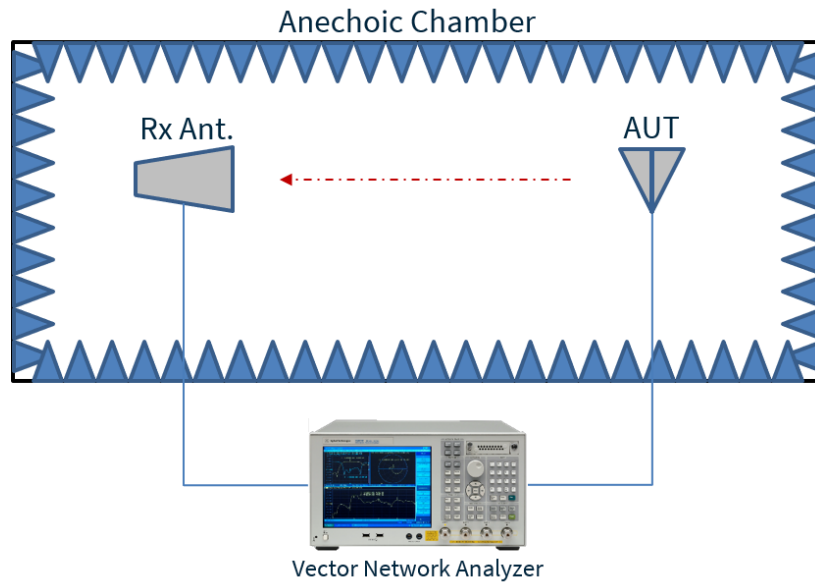

4.2 SGGP.12.4.A.02. Patterns at 1575 MHz

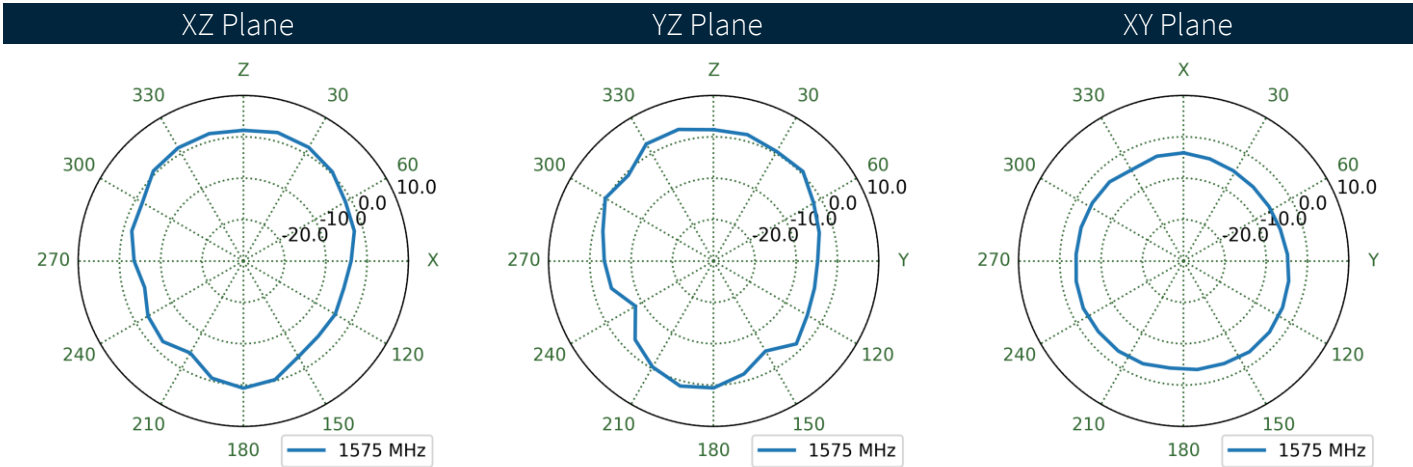
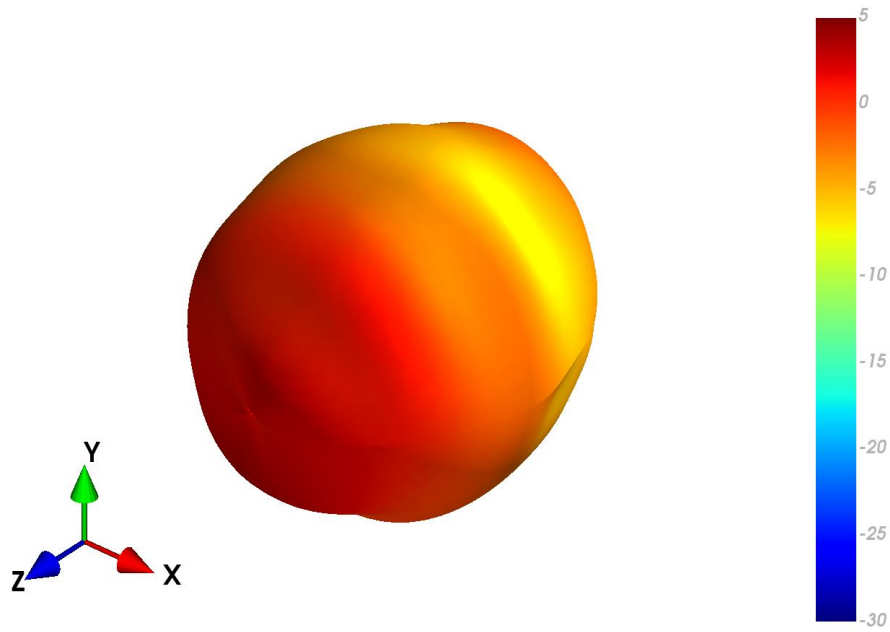

4.3 SGGP.12.4.A.02. Patterns at 1602 MHz

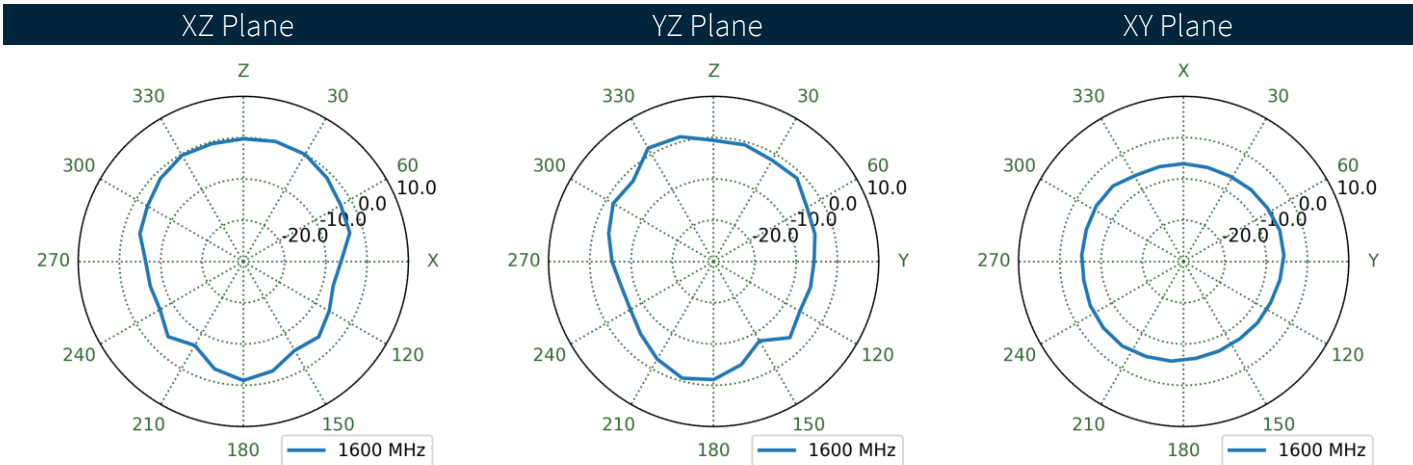
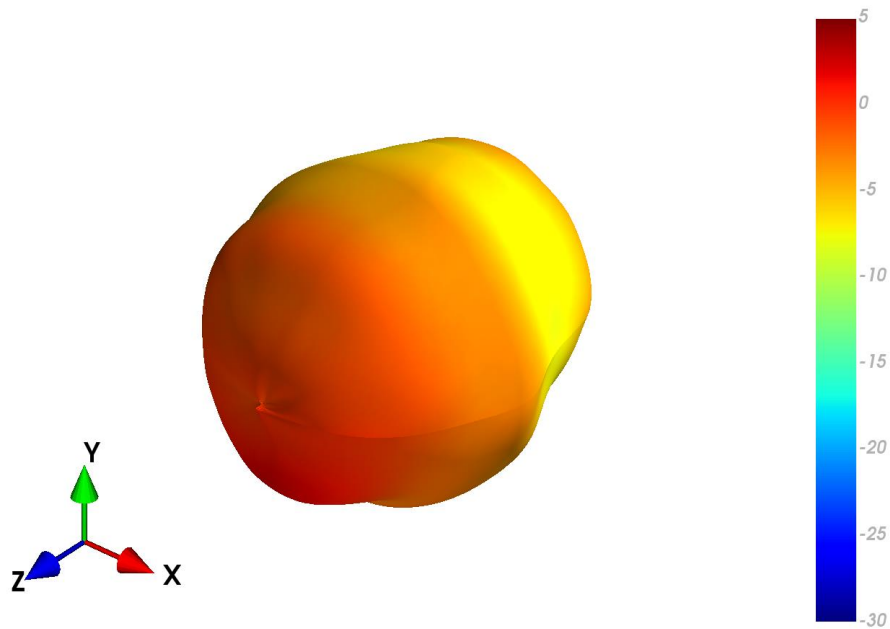

5. Mechanical Drawing

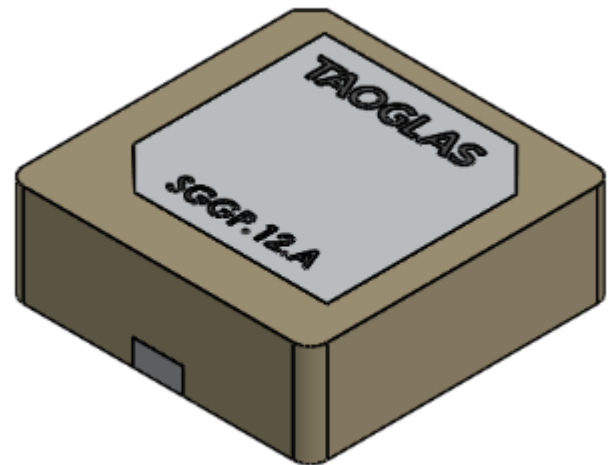
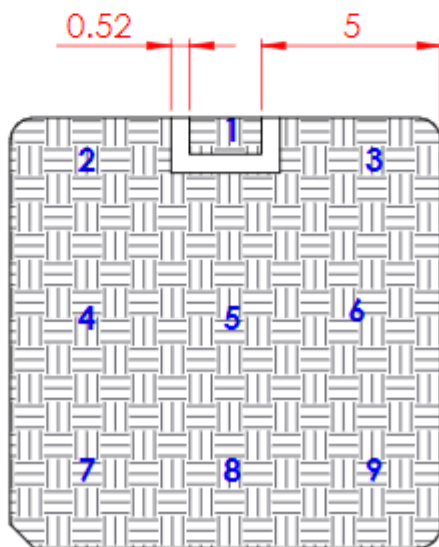
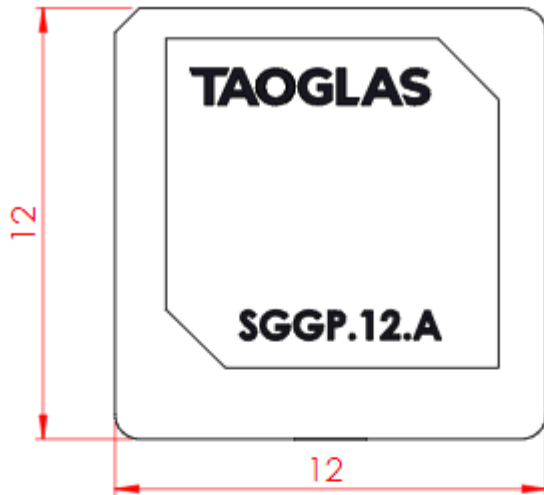

MODEL VIEW

6. Antenna Integration Guide

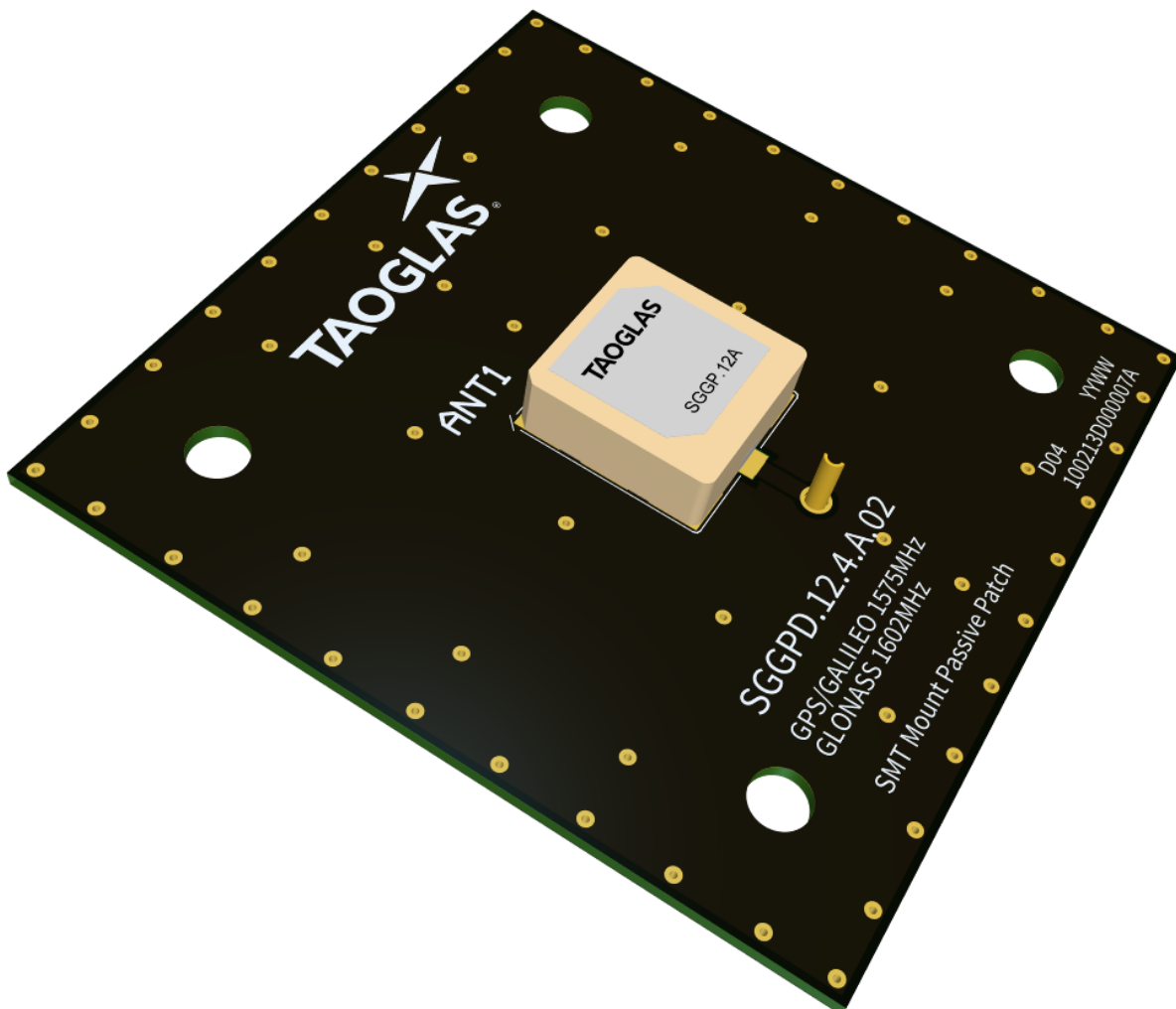

6.1 Schematic and Symbol Definition

The circuit symbol for the antenna is shown below. The antenna has 9 pins as indicated below.

SGGP.12.4.A.02 ANT1

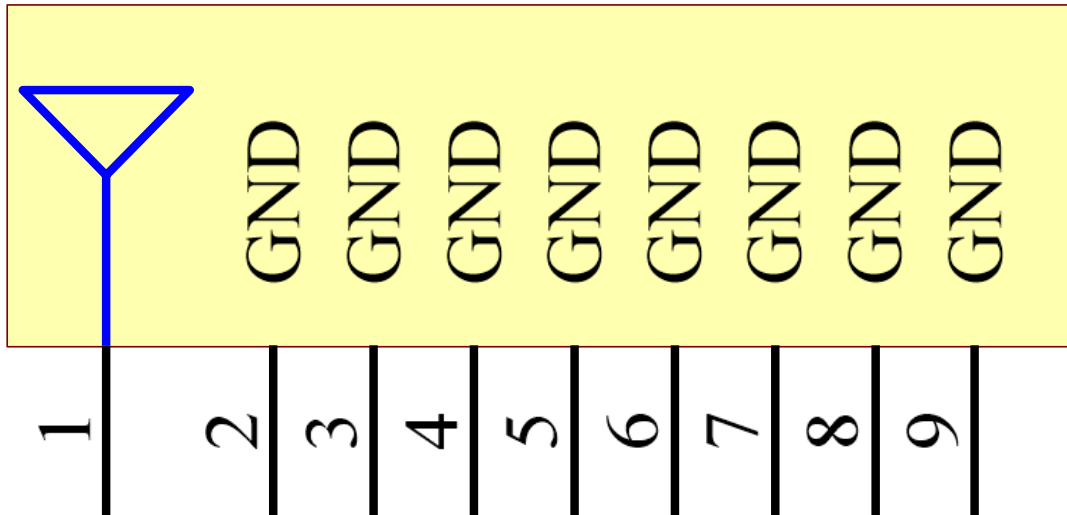

Pin	Description
1	RF Feed
2, 3, 4, 5, 6, 7, 8, 9	Ground

6.2 Antenna Integration

The antenna should be placed at the center of the ground plane with a length and width of 50mm. Maintaining a square symmetric ground plane shape and symmetric environment around the antenna is critical to maintaining the excellent axial ratio and phase center performance shown in this datasheet.



Top Side w/ Solder Mask



Top Side w/o Solder Mask

6.3 PCB Layout

The footprint and clearance on the PCB must comply with the antenna specification. The PCB layout shown in the diagram below demonstrates the antenna footprint.

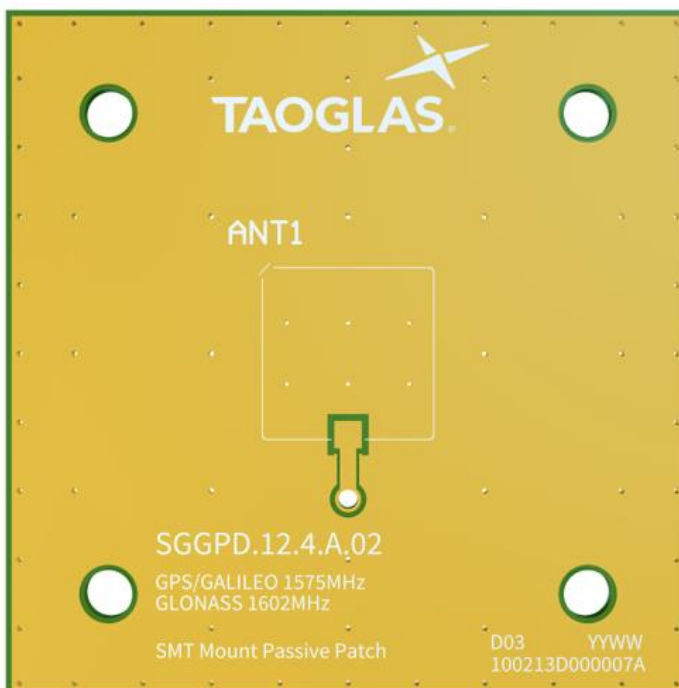

Topside

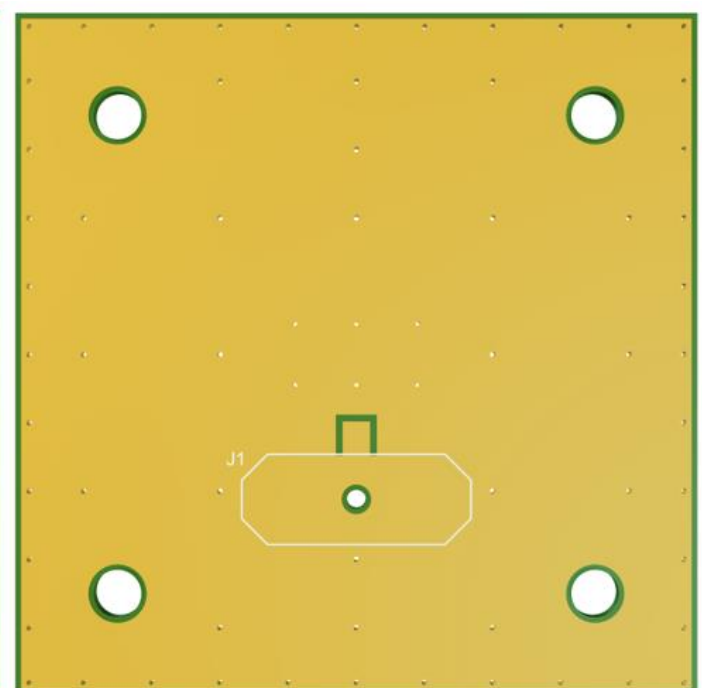

Bottom Side

6.4 Evaluation Board

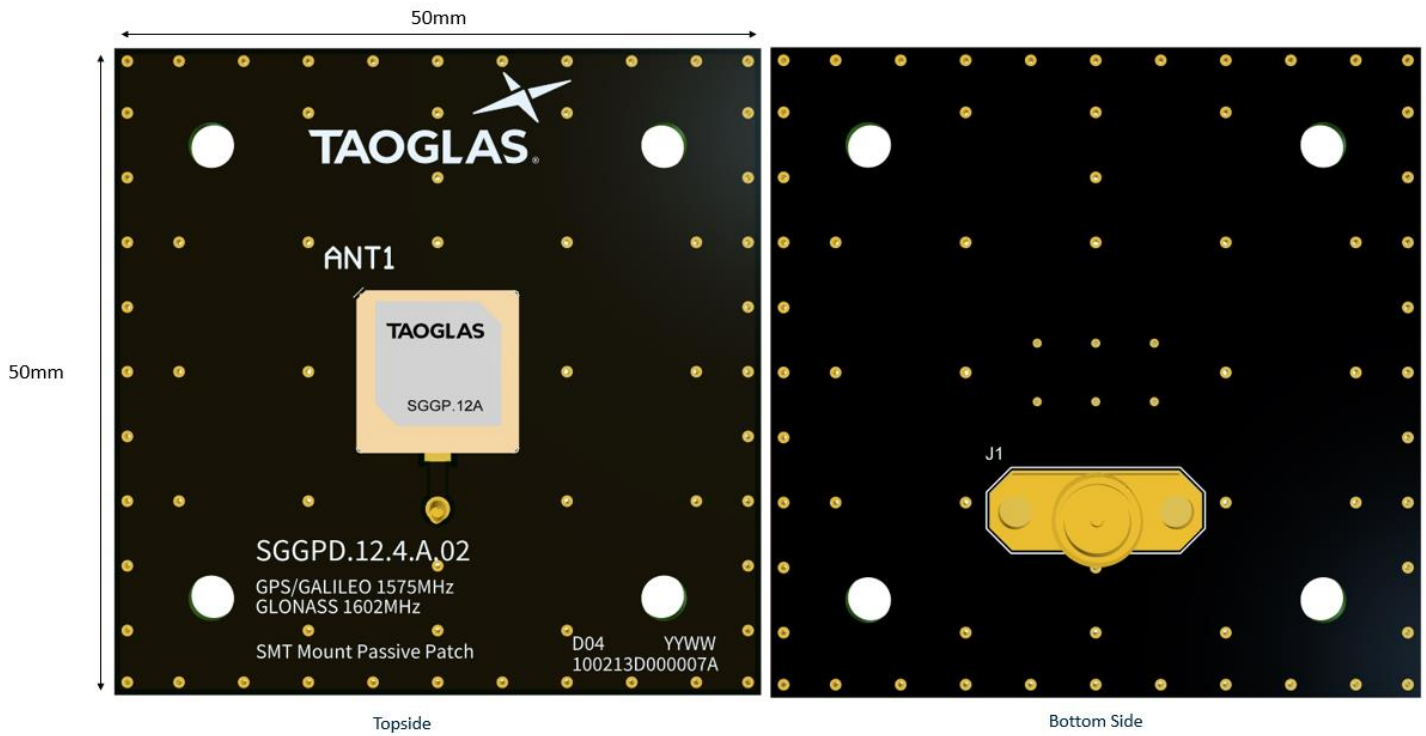

6.5 Footprint

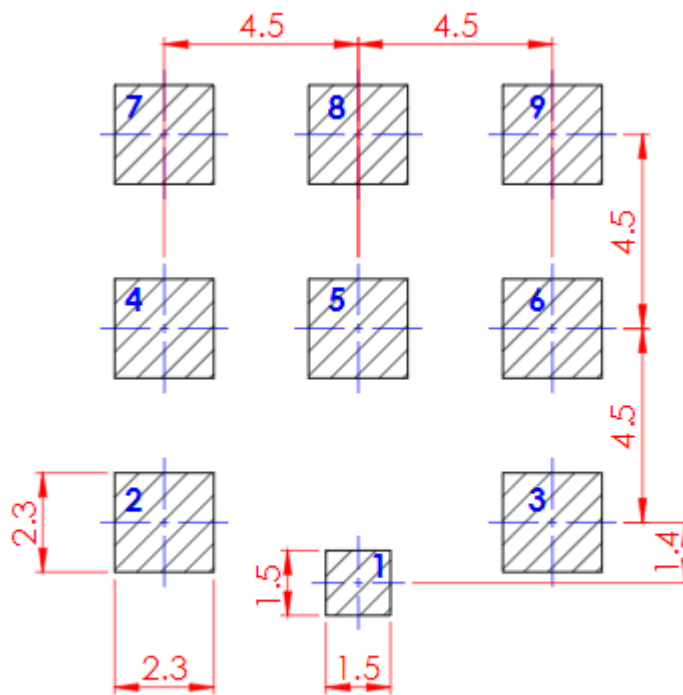

FOOTPRINT PCB
SCALE 6:1

7. Solder Reflow Profile

The SGGP.12.4.A.02 can be assembled by following the recommended soldering temperatures are as follows:

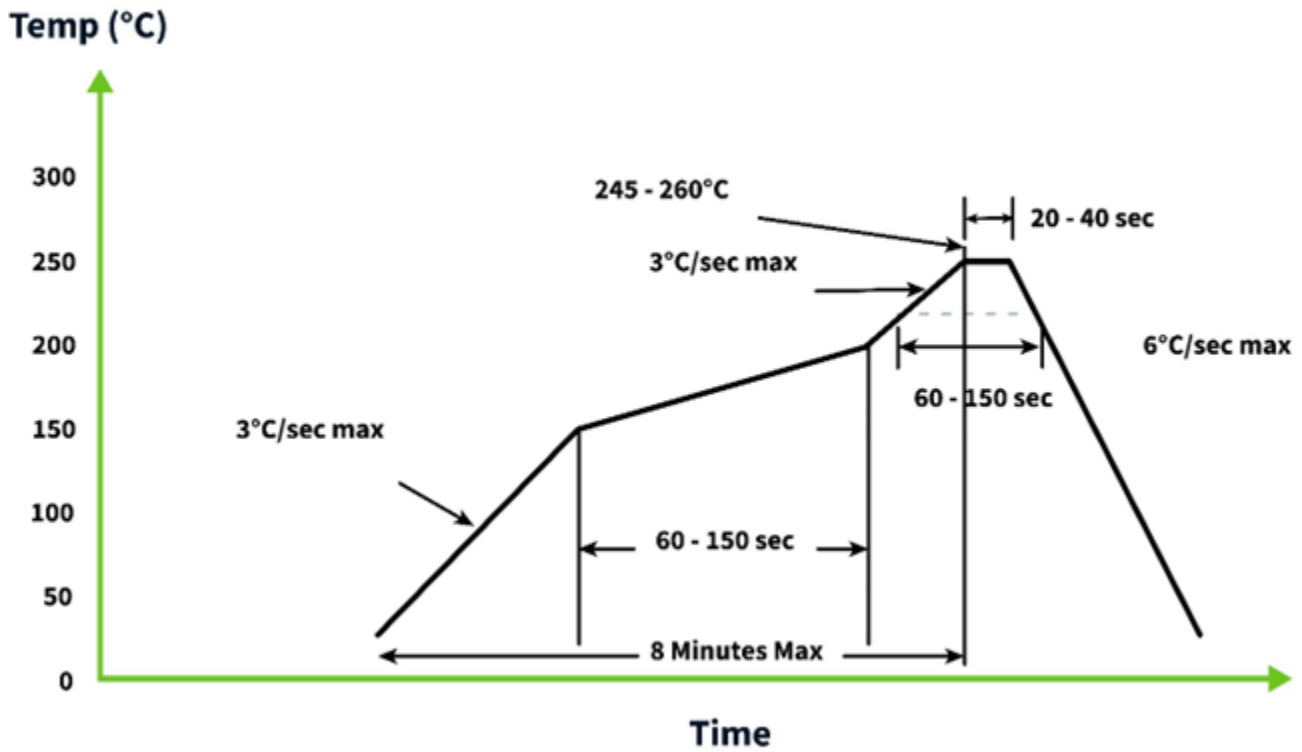

*Temperatures listed within a tolerance of +/- 10° C

Smaller components are typically mounted on the first pass, however, we do advise mounting the SGGP.12.4.A.02 when placing larger components on the board during subsequent reflows.

Note: Soldering flux classified ROL0 under IPC J-STD-004 is recommended.

8. Packaging

500 pc SGGP.12.4.A.02 per reel
 Dimensions - Ø330*38mm
 Weight - 2.0Kg

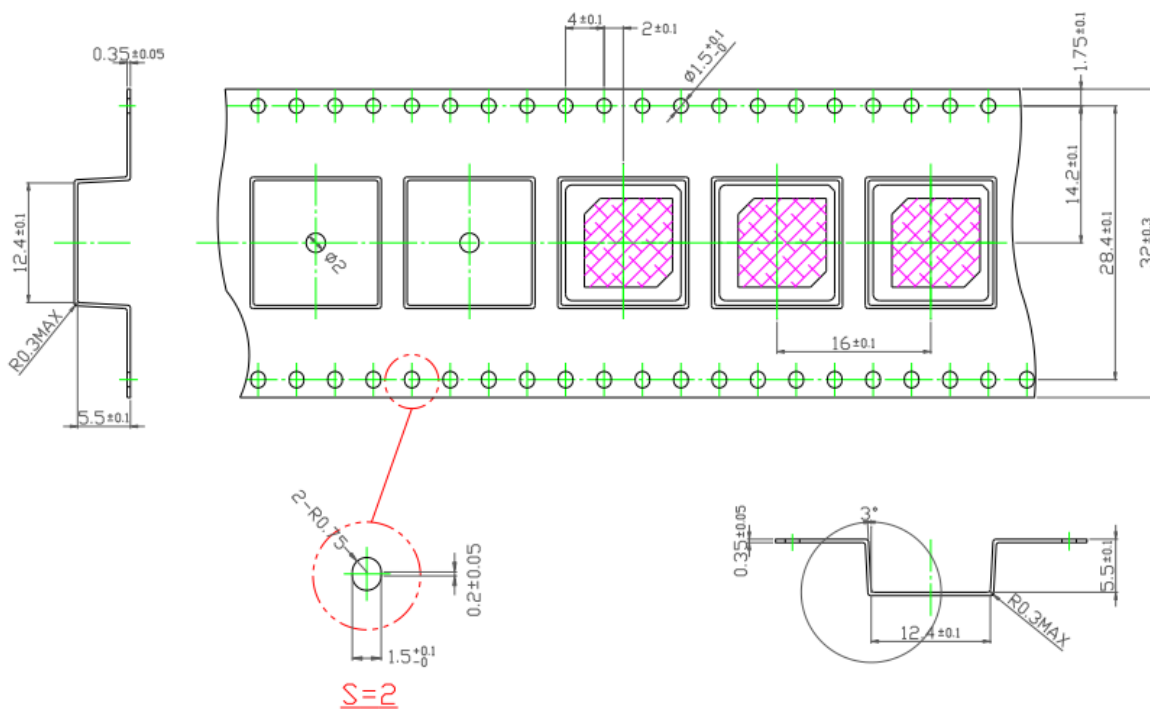
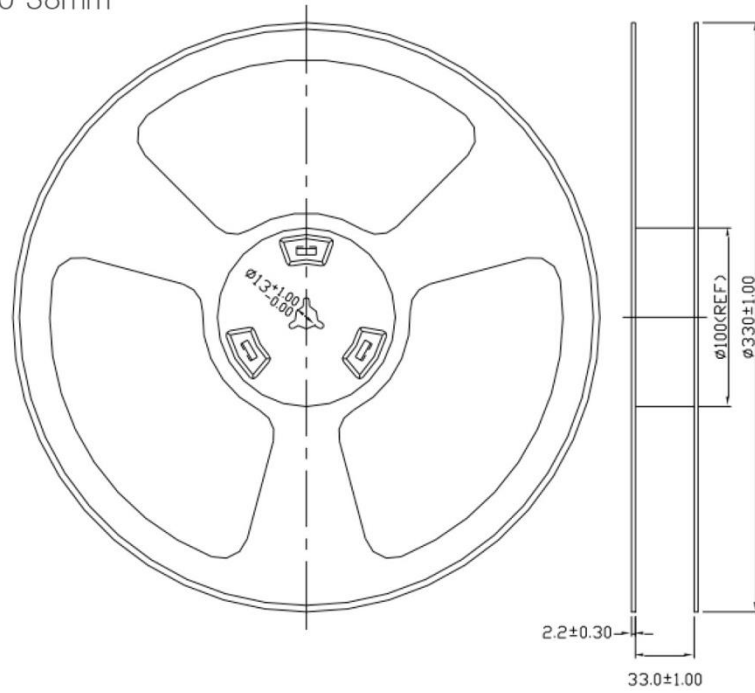

Changelog for the datasheet

SPE-15-8-034- SGGP.12.4.A.02

Revision: D (Current Version)

Date:	2023-09-07
Changes:	Updated Solder Reflow Information
Changes Made by:	Cesar Sousa

Previous Revisions

Revision: C

Date:	2023-04-11
Changes:	Updated environmental specifications
Changes Made by:	Cesar Sousa

Revision: B

Date:	2022-10-24
Changes:	Full Datasheet Update
Changes Made by:	Evan Murphy

Revision: A (Original First Release)

Date:	
Notes:	
Author:	Technical Writer



www.taoglas.com



Looking for pricing, stock, or lifecycle information?

Click below to explore more details on WIN SOURCE:

- ⊖ [View SGGP.12.4.A.02 on WIN SOURCE](#)
- ⊖ [Taoglas Limited Information](#)

Optimize Your Supply Chain with WIN SOURCE Solutions

- ✓ Global Sourcing Solution
- ✓ Obsolete Management
- ✓ Cost Control Management
- ✓ Shortage Management
- ✓ Alternative Solution
- ✓ Excess Inventory Management