



THE DATASHEET OF SDWA.01





Datasheet

Part No:
SDWA.01

Description:

2.4/5-7.125GHz Wi-Fi (Including Wi-Fi 6) Ceramic SMD Antenna

Features:

High Efficiency/ High Peak Gain

2400-2500MHz, 5150-5825MHz, 5925-7125MHz Wi-Fi coverage

Covers newly established Wi-Fi 6 spectrum for future proof design

Small Footprint

Low Profile

Dimensions: 10*4*1.5mm

RoHS & Reach Compliant

1.	Introduction	3
2.	Specifications	4
3.	Antenna Characteristics	5
4.	Radiation Patterns	8
5.	Mechanical Drawing	10
6.	Antenna Integration Guide	11
7.	Mechanical Drawing Evaluation Board	17
8.	Matching Circuit	18
9.	Recommended Soldering Conditions	19
10.	Packaging	20
	Changelog	21

Taoglas makes no warranties based on the accuracy or completeness of the contents of this document and reserves the right to make changes to specifications and product descriptions at any time without notice. Taoglas reserves all rights to this document and the information contained herein. Reproduction, use or disclosure to third parties without express permission is strictly prohibited.



1. Introduction

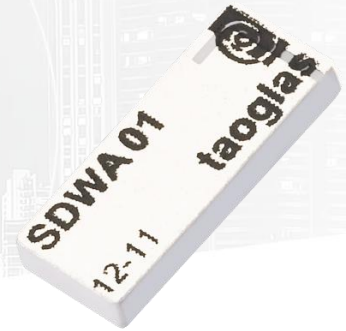

The SDWA.01 SMD ceramic antenna is an embedded, high efficiency, high peak gain solution for Wi-Fi applications which require high-speed data rates and wide coverage areas. Designed for the 2.4 GHz, 5.8 GHz and 7.125GHz bands. The antenna covers the newly established Wi-Fi 6 spectrum for future proof design. It is designed to perform optimally mounted in the corner of a device PCB. Two SDWA.01 antennas can be used for MIMO applications. The antenna's low profile, at only 1.5mm, allows for use on extremely thin devices while still maintaining excellent performance characteristics. This antenna is delivered on Tape and Reel for SMD application.

Many module manufacturers specify peak gain limits for any antennas that are to be connected to that module. Those peak gain limits are based on free-space conditions. In practice, the peak gain of an antenna tested in free space can degrade by at least 1 or 2dBi when put inside a device. So ideally you should go for a slightly higher peak gain antenna than mentioned on the module specification to compensate for this effect, giving you better performance.

Upon testing of any of our antennas with your device and a selection of appropriate layout, integration technique, or cable, Taoglas can make sure any of our antennas' peak gain will be below the peak gain limits. Taoglas can then issue a specification and/or report for the selected antenna in your device that will clearly show it complying with the peak gain limits, so you can be assured you are meeting regulatory requirements for that module.

For example, a module manufacturer may state that the antenna must have less than 2dBi peak gain, but you don't need to select an embedded antenna that has a peak gain of less than 2dBi in free space. This will give you a less optimized solution. It is better to go for a slightly higher free-space peak gain of 3dBi or more if available. Once that antenna gets integrated into your device, performance will degrade below this 2dBi peak gain due to the effects of GND plane, surrounding components, and device housing. If you want to be absolutely sure, contact Taoglas and we will test. Choosing a Taoglas antenna with a higher peak gain than what is specified by the module manufacturer and enlisting our help will ensure you are getting the best performance possible without exceeding the peak gain limits.

For further information, please contact your regional Taoglas customer support team.

2. Specifications

Wi-Fi Electrical							
Band	Frequency (MHz)	Efficiency (%)	Average Gain (dB)	Peak Gain (dBi)	Impedance	Polarization	Radiation Pattern
2.4GHz Wi-Fi	2400~2500	55.7	-2.5	3	50 Ω	Linear	Omni-Directional
5.8GHz Wi-Fi	5150~5850	66.2	-1.9	5.9			
7.1GHz Wi-Fi 6	5925~7125	44.7	-3.6	4.9			

Mechanical	
Height	1.5 mm
Planner Dimension	10 x 4 mm
Material	Ceramic
Evaluation Board Dimensions	100mm*50mm
Weight	1g

Environmental	
Operation Temperature	-40°C to +85°C
Storage Temperature	-40°C to +105°C
Temperature Coefficient (τ_f)	0 \pm 20 ppm @-20°C to +80°C
Humidity	Non-condensing 65°C 95% RH
Recommended Reel Storage Conditions	5°C to 40°C Relative Humidity 20% to 70%
Moisture Sensitivity Level (MSL)	3 (168 Hours)

3. Antenna Characteristics

3.1 Return Loss

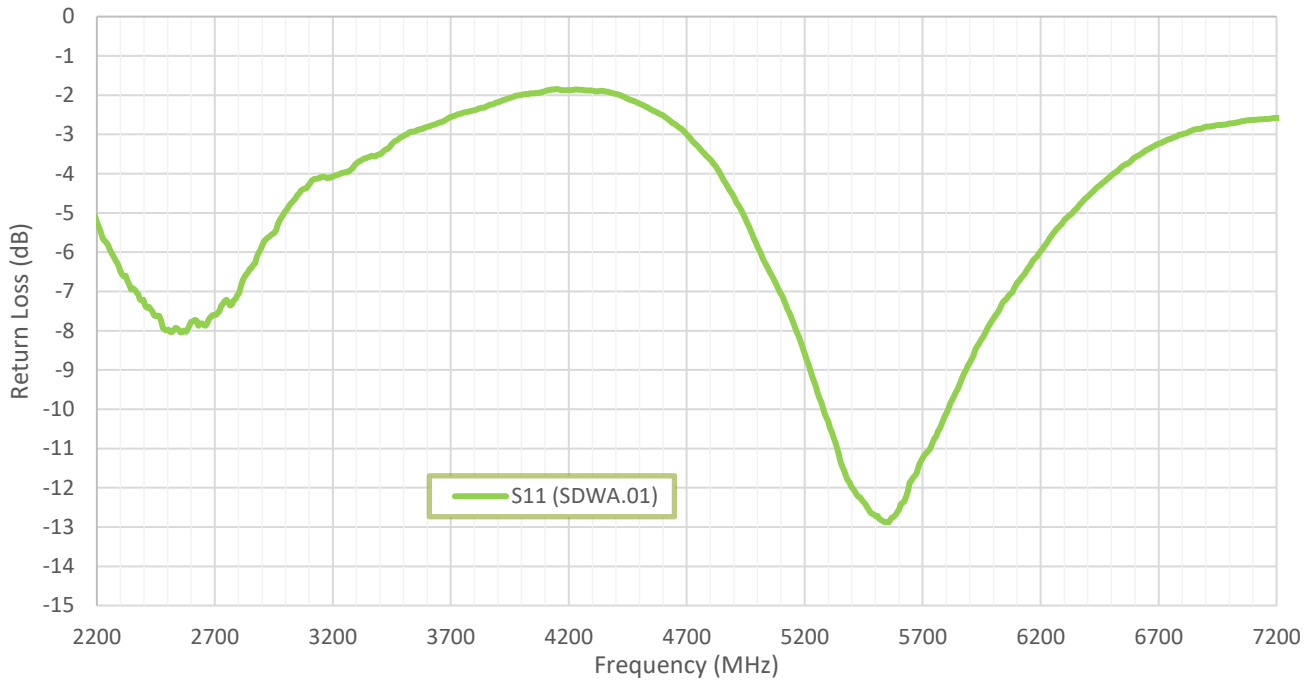

3.2 VSWR

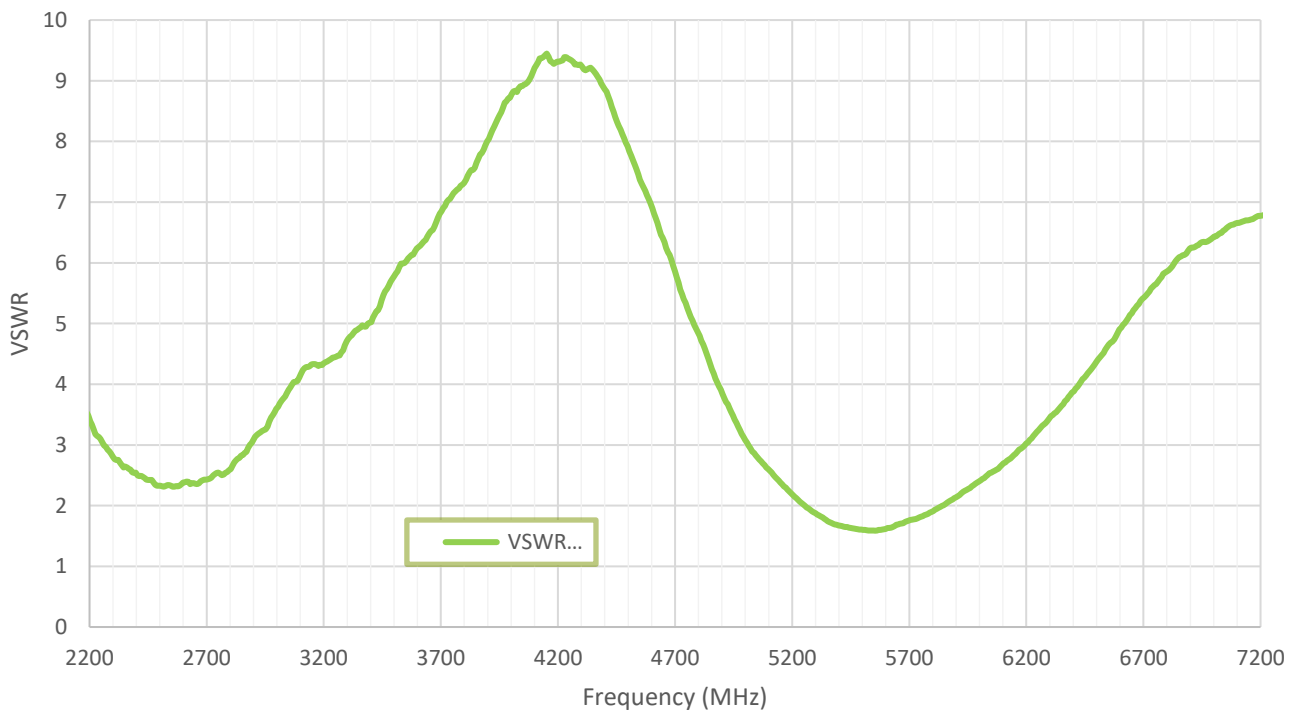

3.3 Efficiency

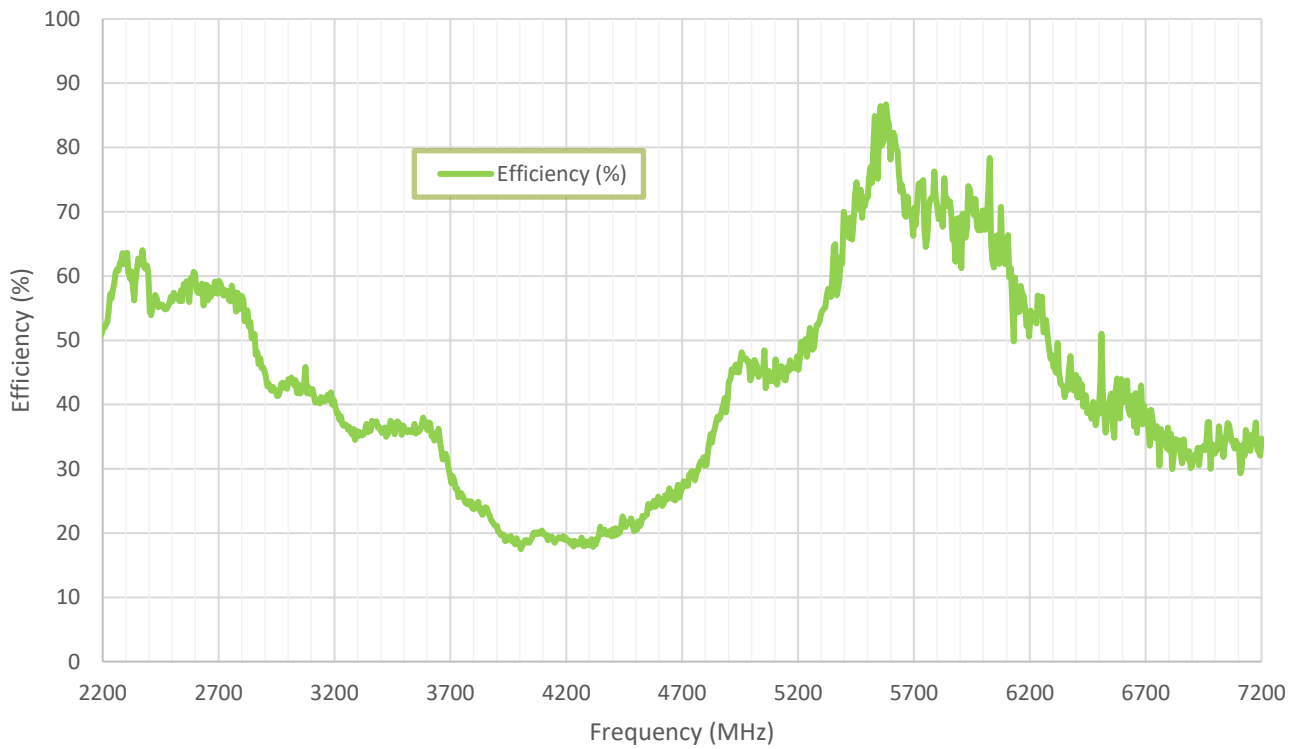

3.4 Peak Gain

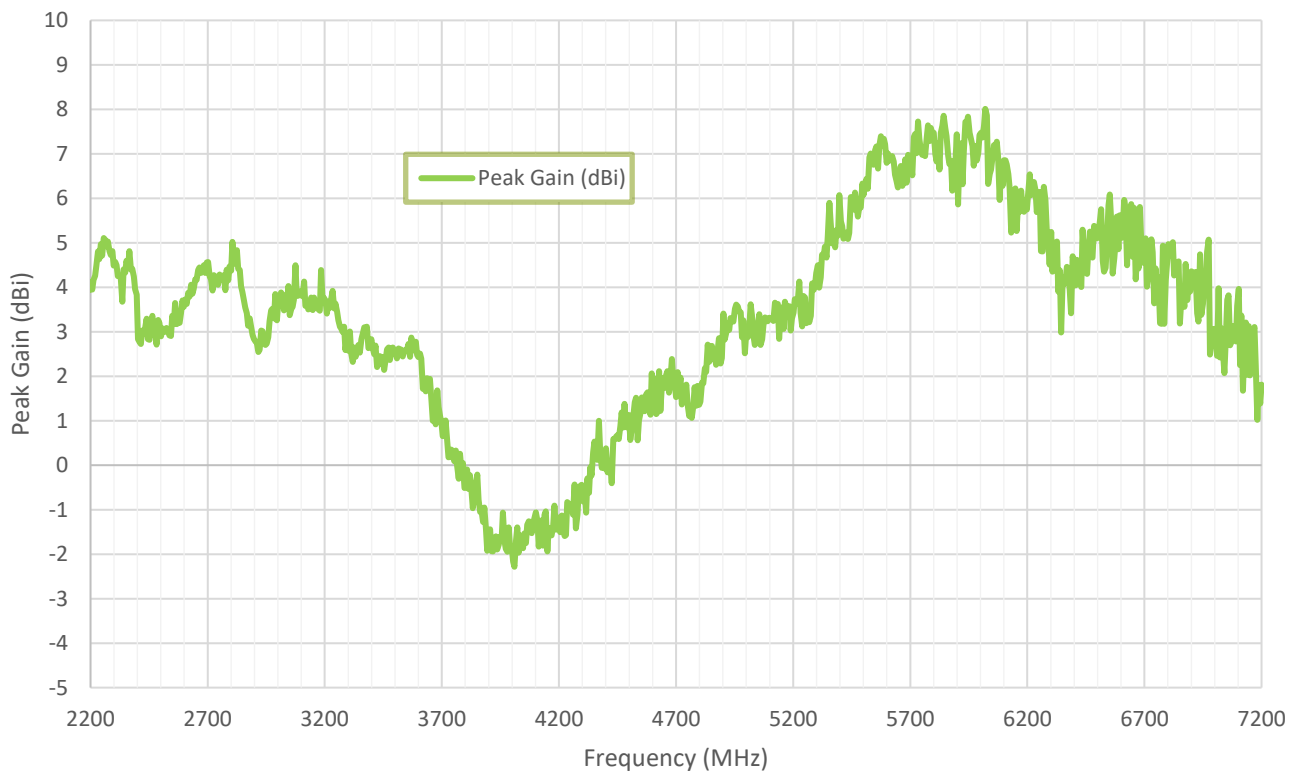

3.5 Average Gain

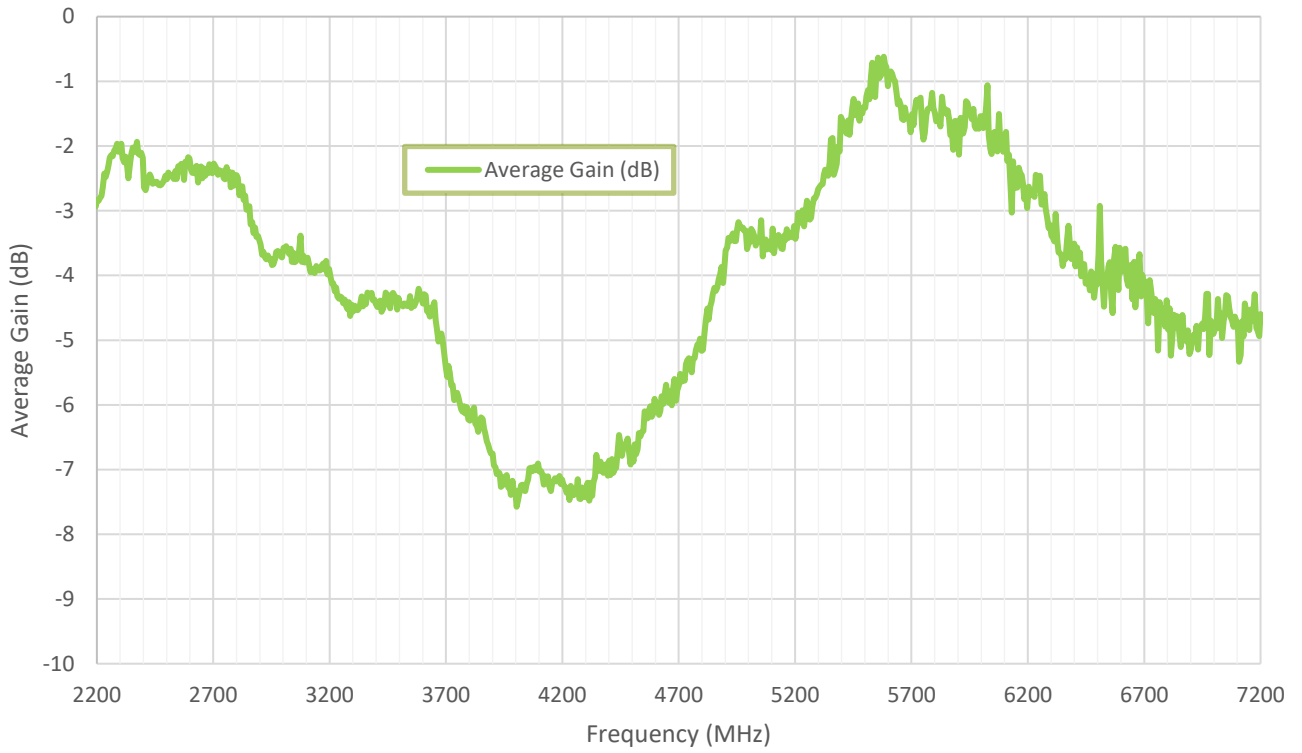

4. 2D Radiation Patterns

4.1 Test Setup – On Eval Board

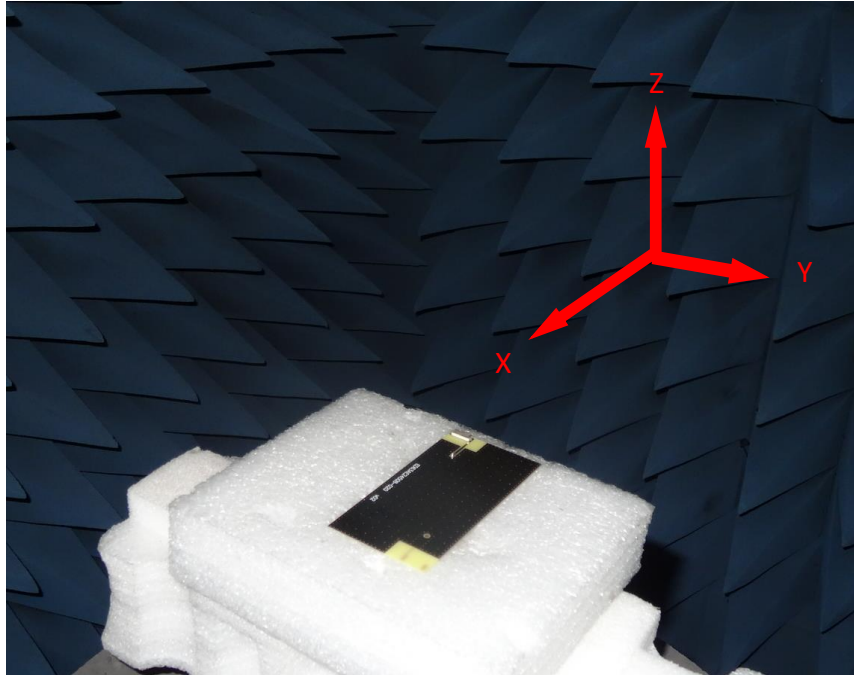

4.2 2D Radiation Patterns

2400-2500MHz

XY Plane

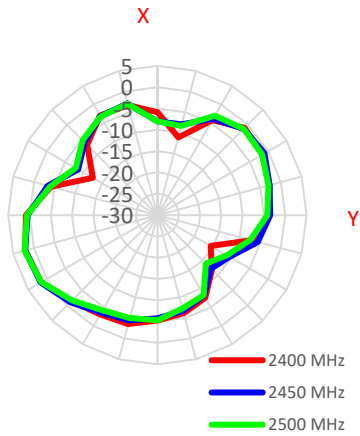

XZ Plane

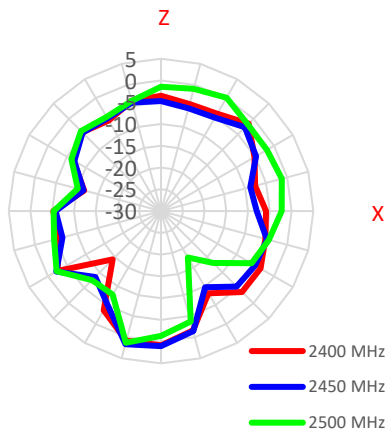

YZ Plane

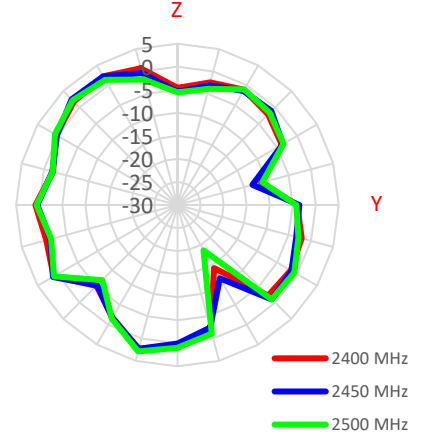

5000-7000MHz

XY Plane

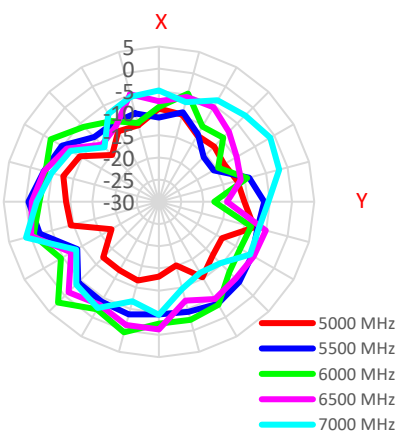

XZ Plane

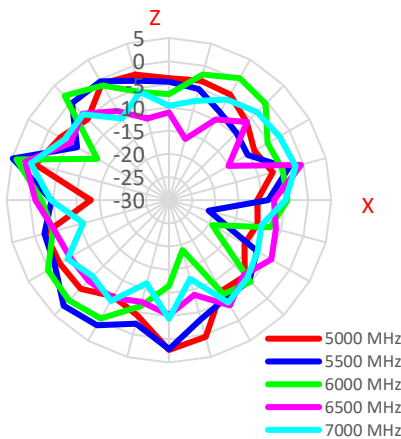

YZ Plane

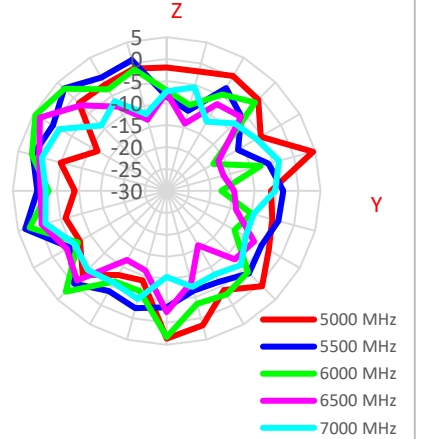

5. Mechanical Drawing (Units: mm)

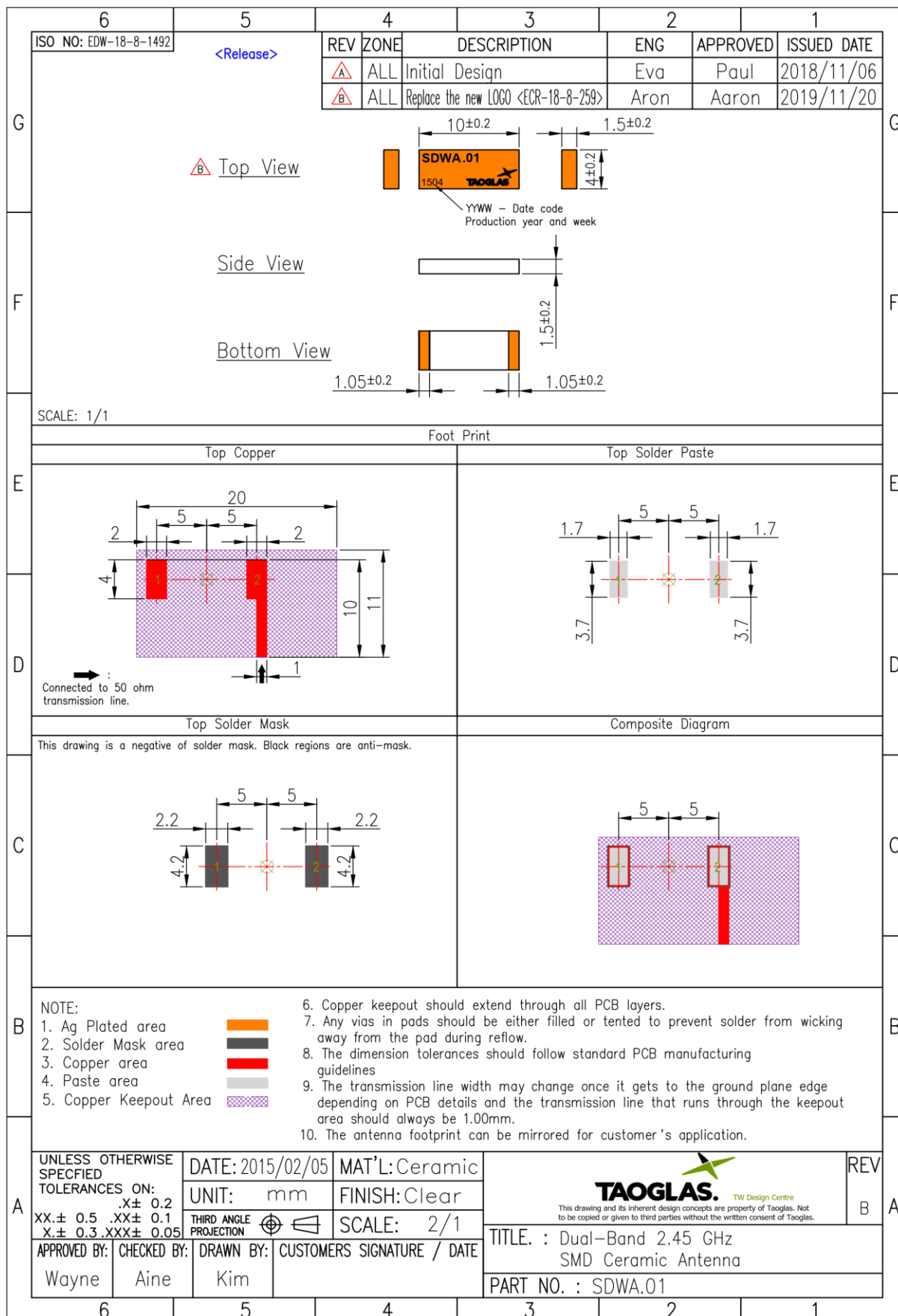

6. Antenna Integration Guide



6.1 Schematic Symbol and Pin Definition

The circuit symbol for the antenna is shown below. The antenna has 2 pins with only one pin (Pin 1) as functional. Pin 2 is for mechanical strength.

Pin	Description
1	RF Feed
2	Mechanical, Not Connected

SDWA.01
ANT1

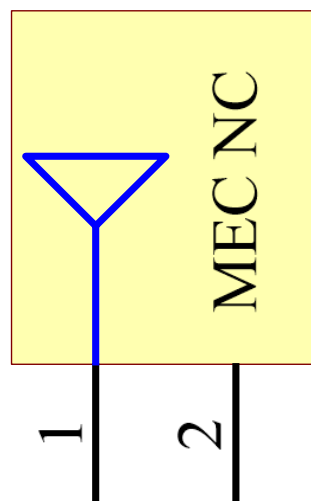

6.2 Antenna Integration

For any given PCB size, the antenna should ideally be placed on the PCB's shortest side, to take advantage of the ground plane. Optimized matching components can be placed as shown.

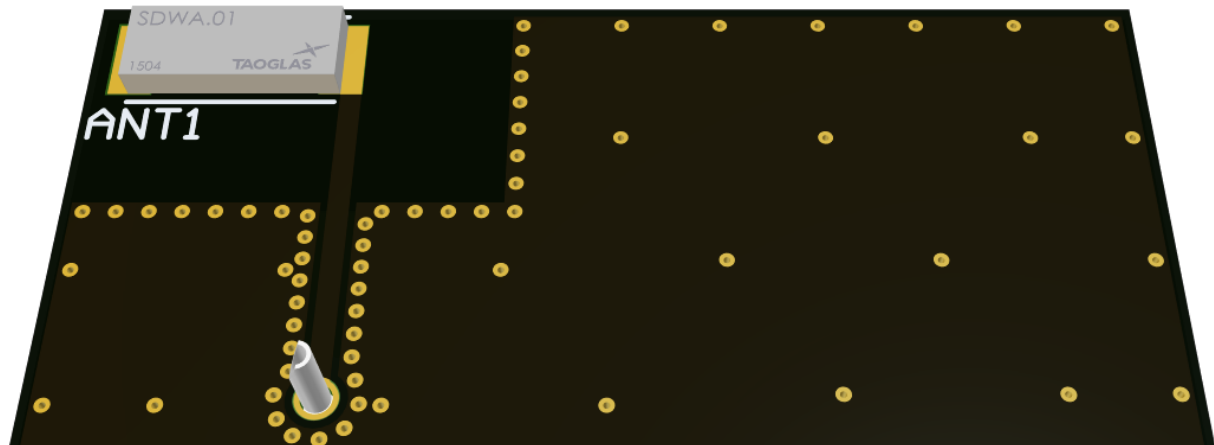

Top Side w/ Solder Mask

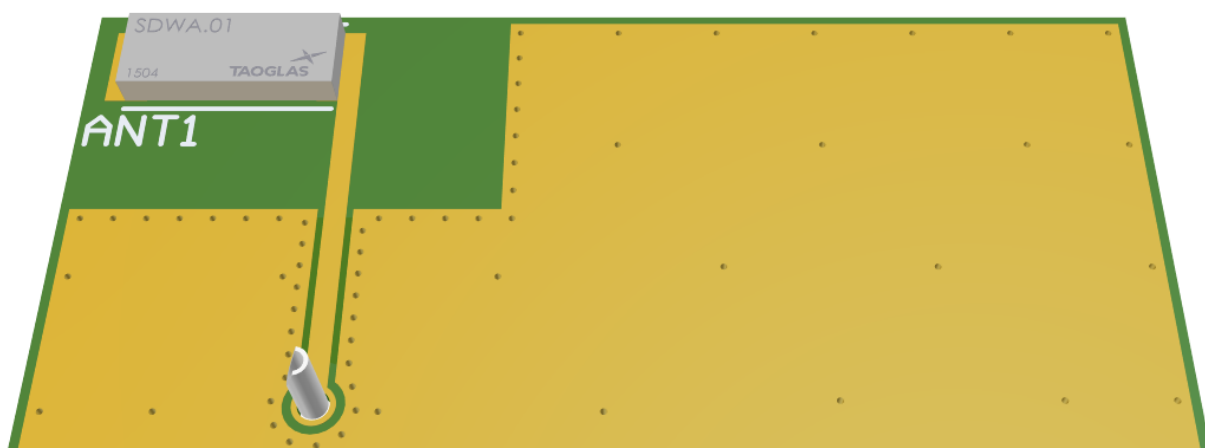

Top Side w/o Solder Mask

6.3 PCB Layout

The footprint and clearance on the PCB must meet the layout drawing in (Footprint Drawing).



Topside

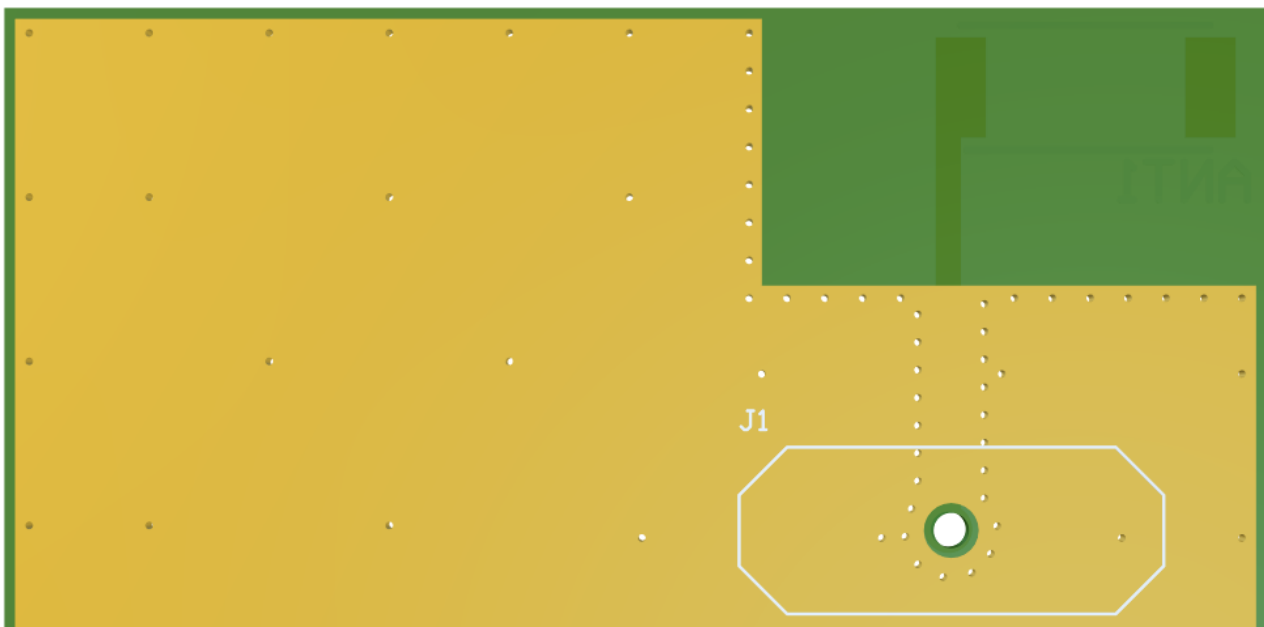

Bottom Side

6.4 PCB Clearance

Below shows the antenna footprint and clearance through ALL layers on the PCB. Only the antenna pads and connections to feed are present within this clearance area (marked RED). The clearance area extends to 10mm in width and 20mm in length from the top right corner of the PCB. This clearance area includes the bottom side and ALL internal layers on the PCB.

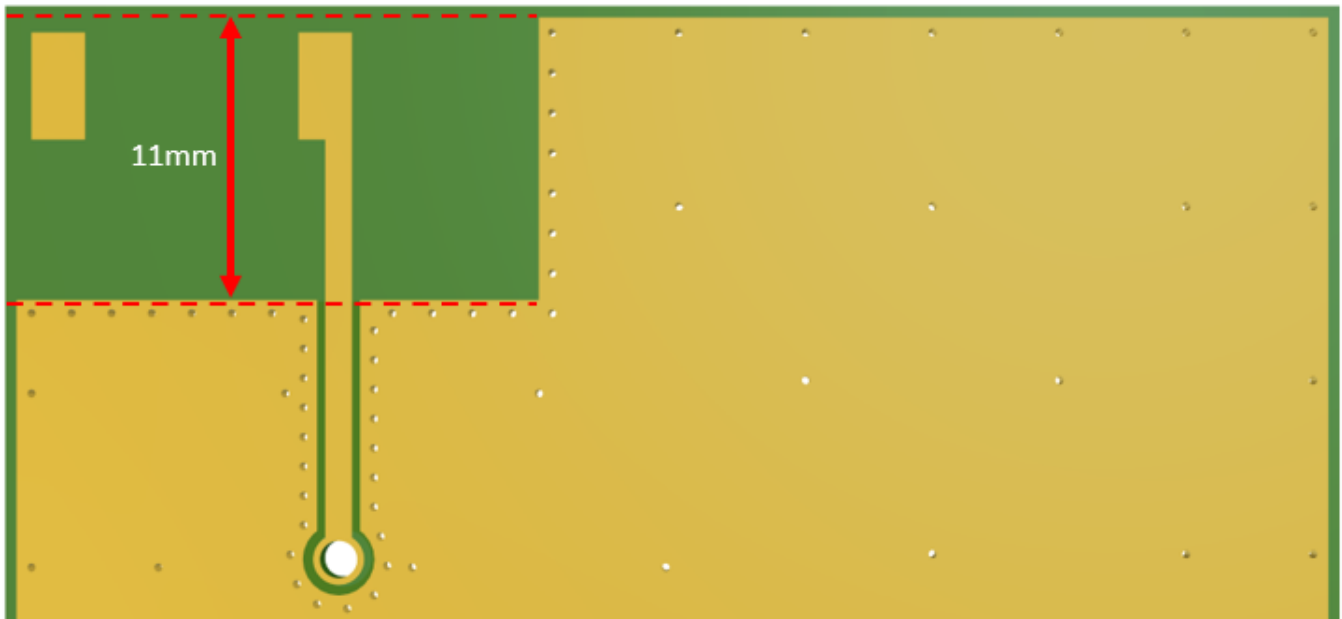

Topside

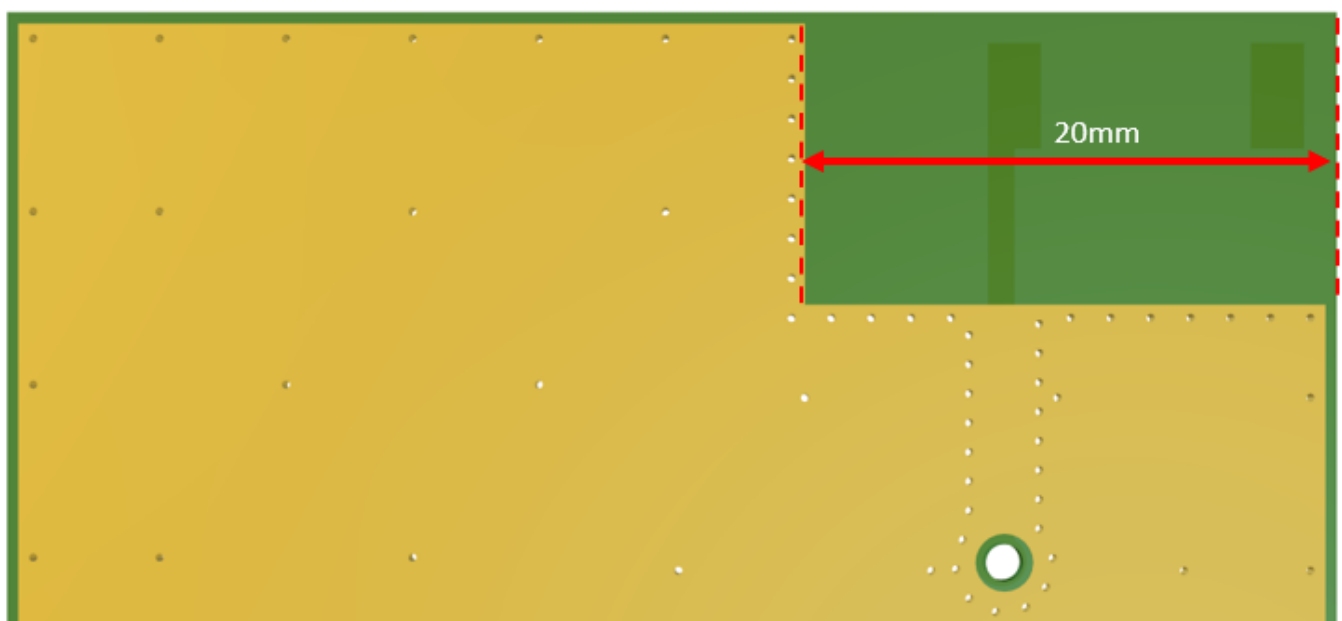

Bottom Side

6.5 Evaluation Board

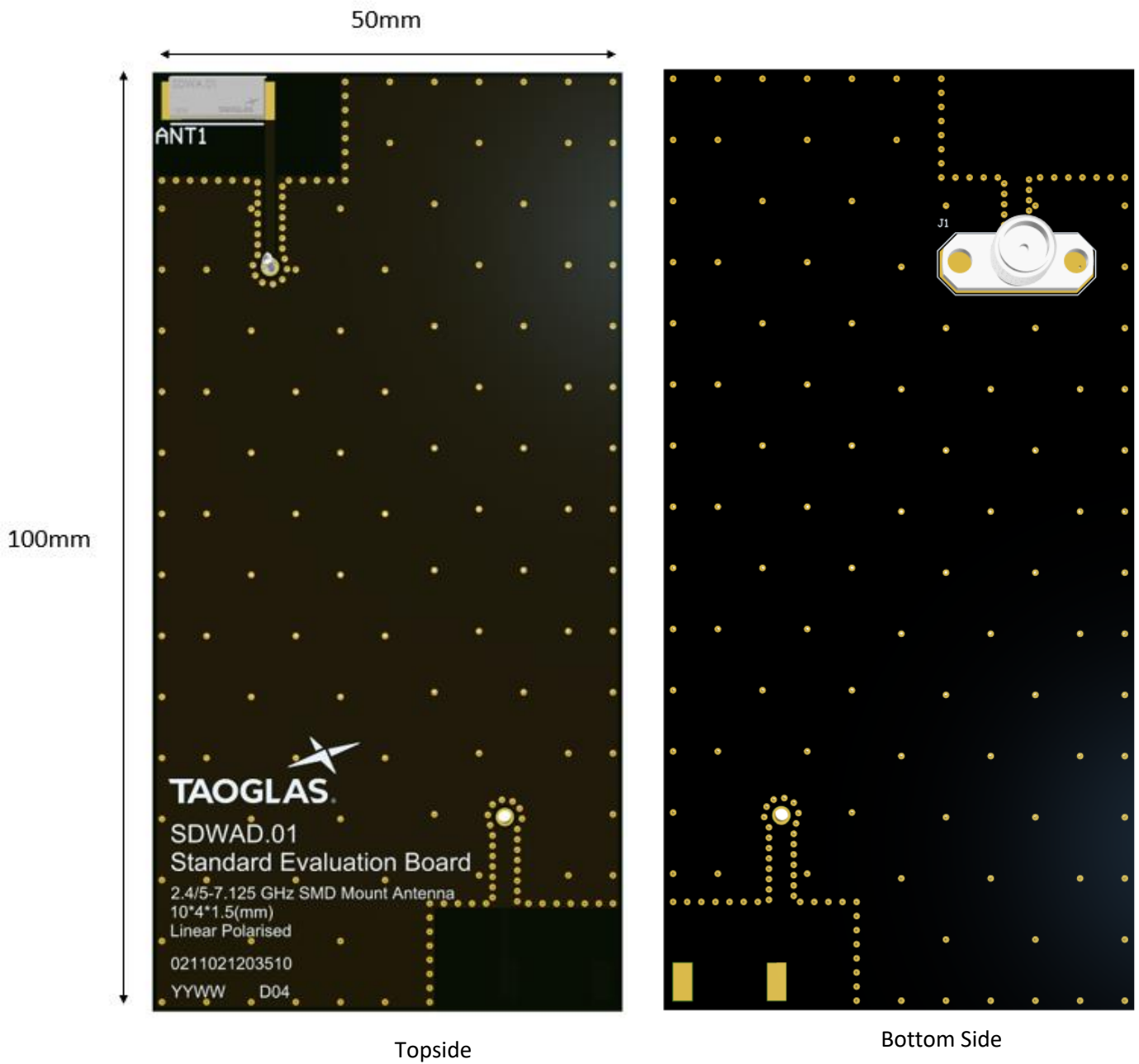

8. Matching Circuit

Like all antennas, surrounding components, enclosures, and changes to the GND plane dimensions can alter performance. A pi-matching network like the one shown below is required in case adjustments need to be made. Make S1 a zero ohm resistor and leave S2 and S3 unpopulated when building first prototypes. These components will likely need to be adjusted upon integration to provide the best match between the antenna and transmission line. The additional zero ohm resistor in the diagram is needed for the ability to solder down a coax pigtail to make measurements with a vector network analyzer.

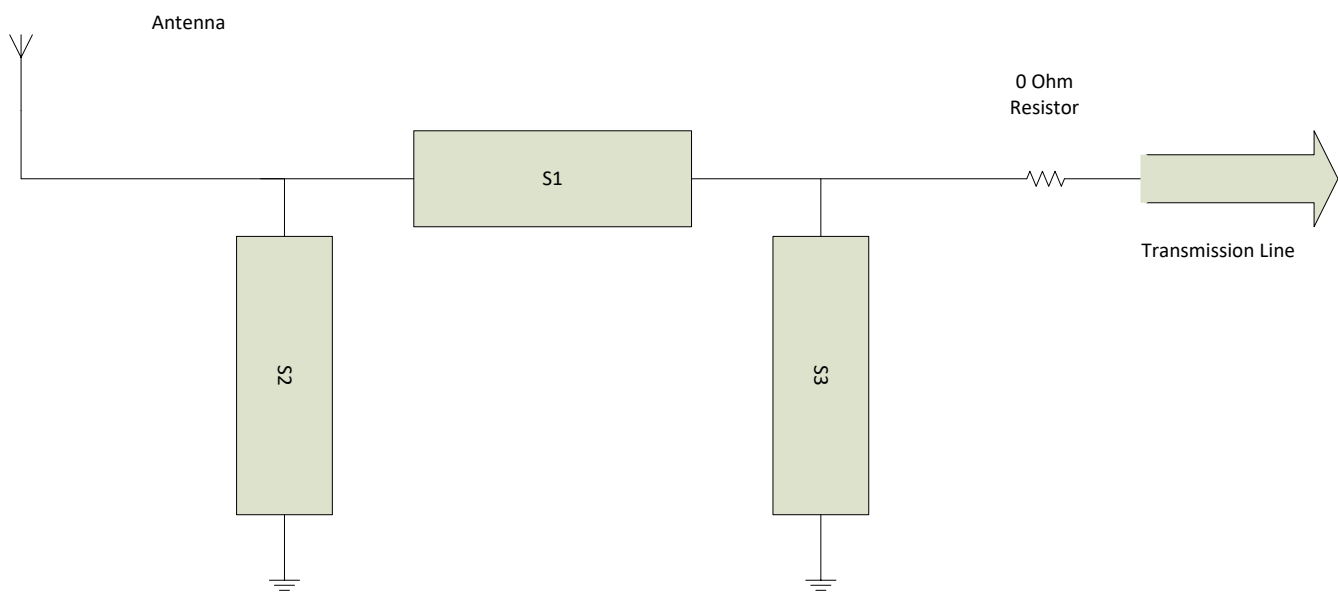

9. Recommended Soldering Conditions

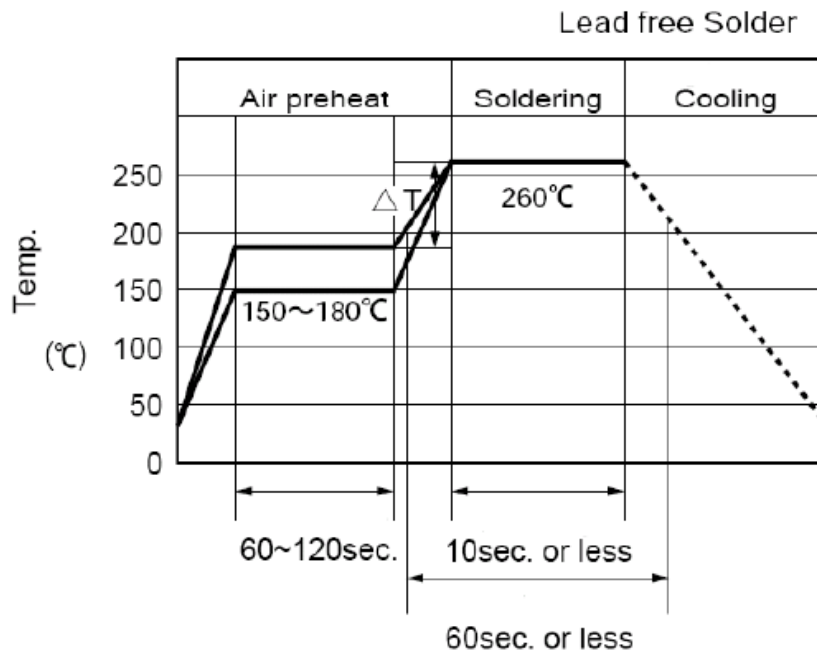

1. Time shown in the above figures is measured from the point when chip surface reaches temperature.
2. Temperature difference in high temperature part should be within 110°C.
3. After soldering, do not force cool, allow the parts to cool gradually.

***General attention to soldering:**

- High soldering temperatures and long soldering times can cause leaching of the termination, decrease in adherence strength, and the change of characteristic may occur.
- for soldering, please refer to the soldering curves above. However, please Keep exposure to temperatures exceeding 200°C to under 50 seconds.
- please use a mild flux (containing less than 0.2wt% Cl). Also, if the flux is water soluble, be sure to wash thoroughly to remove any residue from the underside of components that could affect resistance.

Cleaning:

When using ultrasonic cleaning, the board may resonate if the output power is too high. Since this vibration can cause cracking or a decrease in the adherence of the termination, we recommend that you use the conditions below.

- Frequency: 40 kHz max.
- Output power: 20W/liter
- Cleaning time: 5minutes max.

10. Packaging

1000pcs SDWA.01 per Tape & Reel

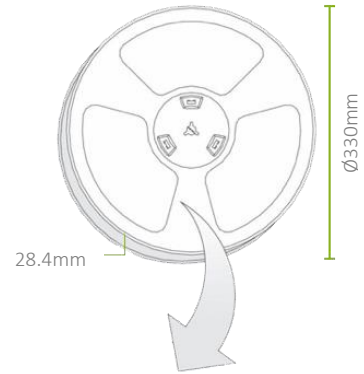

1000pcs SDWA.01 per carton
Dimensions - 350*340*47mm

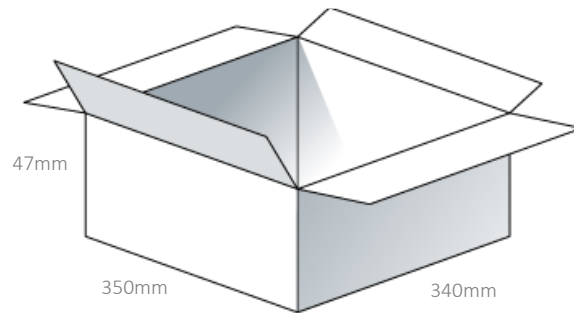

5000pcs SDWA.01 per carton
Dimensions - 370*370*300mm

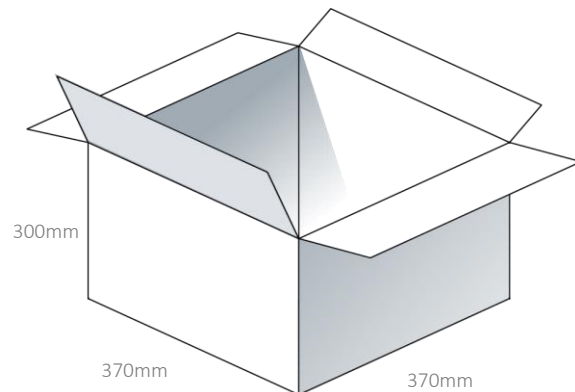

Changelog for the datasheet

SPE-11-8-129 – SDWA.01

Revision: M (Current Version)

Date:	2023-03-16
Changes:	Antenna Integration Guide Added
Changes Made by:	Cesar Sousa

Previous Revisions

Revision: L

Date:	2022-05-13
Changes:	Updated Packaging
Changes Made by:	Jack Conroy

Revision: G

Date:	2017-03-08
Changes:	Packaging Details Updated
Changes Made by:	Aine Doyle

Revision: K (Current Version)

Date:	20208-09-03
Changes:	Added Wi-Fi 6 test data
Changes Made by:	Jack Conroy

Revision: F

Date:	2016-03-08
Changes:	Amended SPQ
Changes Made by:	Aine Doyle

Revision: J

Date:	2019-06-11
Changes:	Evaluation Board Drawing Updated
Changes Made by:	Jack Conroy

Revision: E

Date:	2015-08-20
Changes:	Packaging Details Updated
Changes Made by:	Aine Doyle

Revision: I

Date:	2019-08-26
Changes:	EC-19-8-071
Changes Made by:	Jack Conroy

Revision: D

Date:	2015-03-02
Changes:	Amended Drawing
Changes Made by:	Aine Doyle

Revision: H

Date:	2018-03-08
Changes:	Packaging Details Updated
Changes Made by:	Made by Andy Mahoney

Revision: C

Date:	2013-11-08
Changes:	Amended Reel Quantity
Changes Made by:	Aine Doyle

Revision: B	
Date:	2013-08-19
Changes:	Packaging Details Updated
Changes Made by:	Aine Doyle

Revision: A (Original First Release)	
Date:	2017-10-27
Notes:	
Author:	Technical Writer



www.taoglas.com



Looking for pricing, stock, or lifecycle information?

Click below to explore more details on WIN SOURCE:

- ⊖ [View SDWA.01 on WIN SOURCE](#)
- ⊖ [Taoglas Limited Information](#)

Optimize Your Supply Chain with WIN SOURCE Solutions

- ✓ Global Sourcing Solution
- ✓ Obsolete Management
- ✓ Cost Control Management
- ✓ Shortage Management
- ✓ Alternative Solution
- ✓ Excess Inventory Management