



# THE DATASHEET OF HMC615LP4E





# HMC615LP4 / 615LP4E

## GaAs MMIC MIXER w/ INTEGRATED LO AMPLIFIER, 2.3 - 4.0 GHz

### Typical Applications

The HMC615LP4E is ideal for:

- PCS / 3G Infrastructure
- Base Stations & Repeaters
- WiMAX & WiBro
- ISM & Fixed Wireless

### Features

- High Input IP3: +35 dBm
- Low Input LO Drive: -2 to +6 dBm
- Low Conversion Loss: 10 dB
- Single Positive Supply: +5V @ 65 mA
- 24 Lead 4x4mm QFN Package: 9 mm<sup>2</sup>

### Functional Diagram

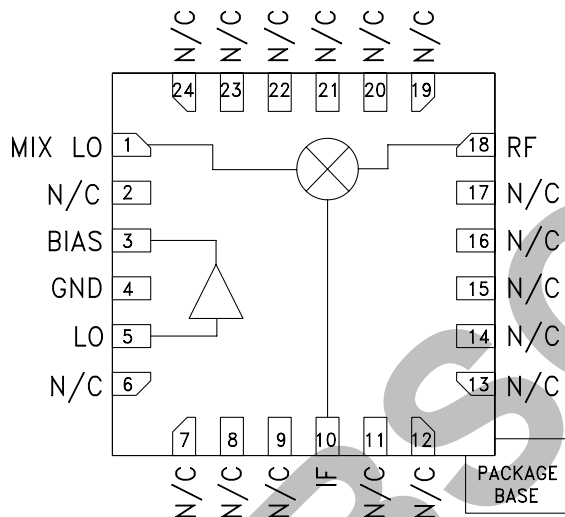

### General Description

The HMC615LP4(E) are high linearity, GaAs FET converter ICs that operate from 2.3 to 4.0 GHz and deliver a +35 dBm input third order intercept point. The LO amplifier output and high dynamic range mixer input are positioned so that an external LO filter can be placed in series between them. The IC operates from a single +5V supply consuming 65 mA of current and accepts a LO drive level of -2 to +6 dBm. The design requires no external baluns and supports IF frequencies between DC and 1 GHz. The HMC615LP4(E) is pin for pin compatible with the HMC551LP4(E), HMC552LP4(E) and HMC215LP4(E), which operate from 0.8 to 4.0 GHz. For availability on Non-RoHS HMC615LP4 products please contact Hittite Microwave sales directly.

### Electrical Specifications, $T_A = +25^\circ\text{C}$ , LO = 4 dBm, Vcc = +5V, R1 = 18 Ohms, IF = 200 MHz\*

| Parameter                      | Min.      | Typ. | Max. | Units |
|--------------------------------|-----------|------|------|-------|
| Frequency Range, RF, LO        | 2.3 - 4.0 |      |      | GHz   |
| Frequency Range, IF            | DC - 1.0  |      |      | GHz   |
| Conversion Loss *              |           | 10   | 13   | dB    |
| Noise Figure (SSB)             |           | 10   |      | dB    |
| LO to RF Isolation             | 5         | 15   |      | dB    |
| LO to IF Isolation *           | 1         | 10   |      | dB    |
| IP3 (Input)                    |           | 35   |      | dBm   |
| 1 dB Compression (Input)       |           | 21   |      | dBm   |
| LO Drive Input Level (Typical) | -2 to +6  |      |      | dBm   |
| Supply Current (Icc)           |           | 65   | 75   | mA    |

\*Unless otherwise noted, all measurements performed as a downconverter configured as shown in application circuit.



# HMC615LP4 / 615LP4E

## GaAs MMIC MIXER w/ INTEGRATED LO AMPLIFIER, 2.3 - 4.0 GHz

**Conversion Gain vs. Temperature @ LO = 4 dBm**

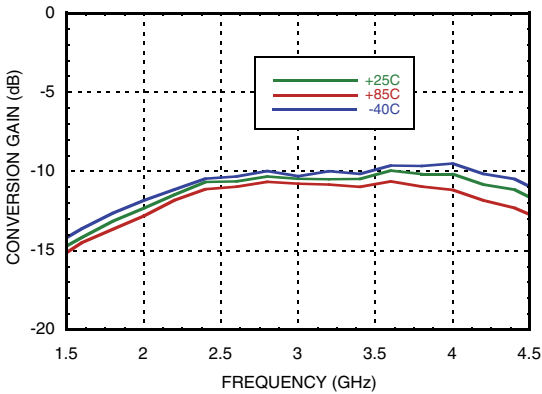

**Isolation @ LO = 4 dBm**

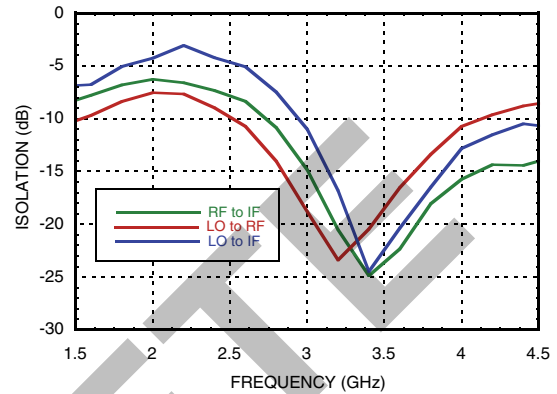

**Conversion Gain vs. LO Drive**

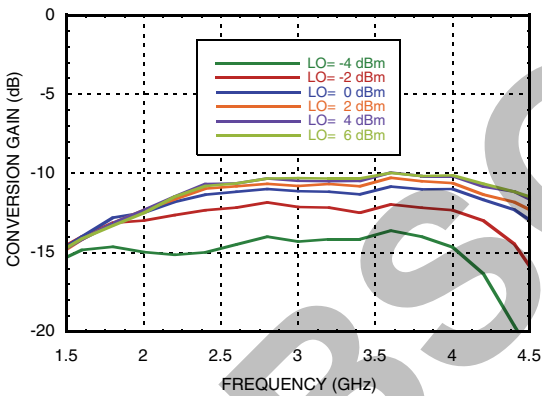

**Return Loss @ LO = 4 dBm**

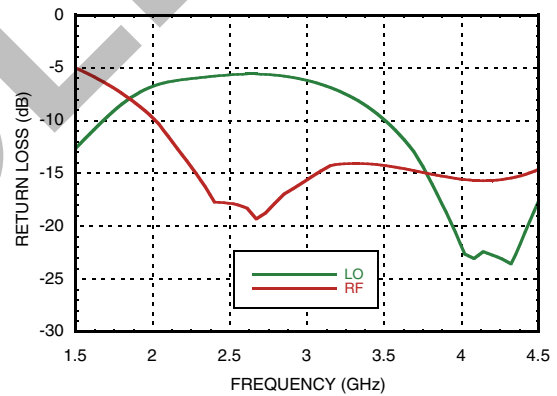

**Upconverter Performance (IF = 100 MHz) Conversion Gain vs. LO Drive**

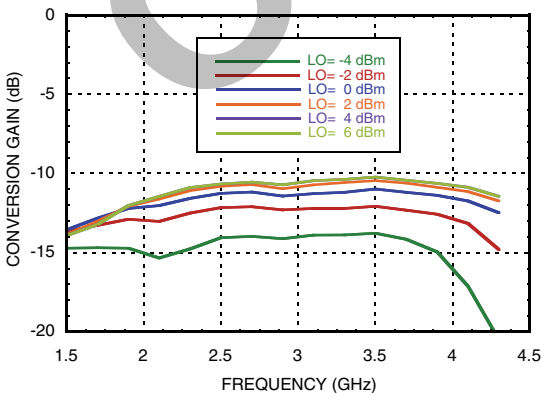

**IF Bandwidth @ LO = 4 dBm**

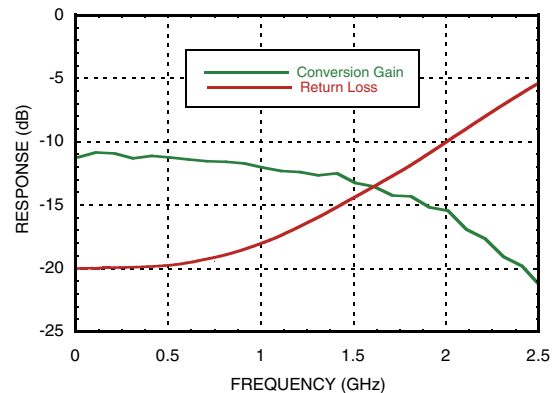



# HMC615LP4 / 615LP4E

## GaAs MMIC MIXER w/ INTEGRATED LO AMPLIFIER, 2.3 - 4.0 GHz

MIXERS - HIGH IP3 - SMT

**Input IP3 vs. Temperature @ LO = 4 dBm**

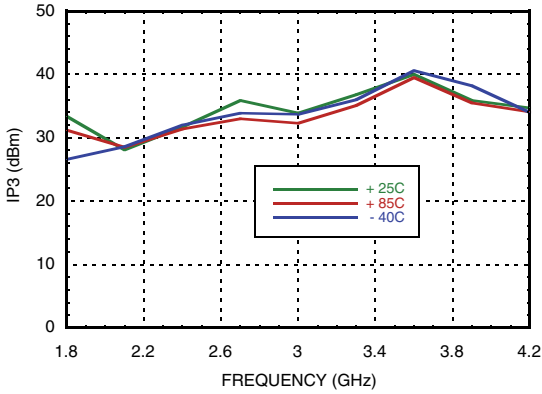

**Input IP3 vs. LO Drive**

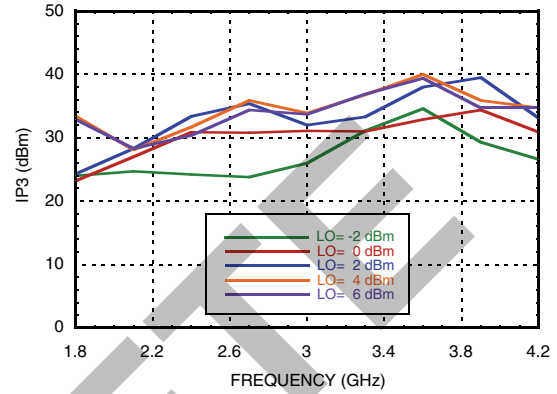

**Input IP2 vs. Temperature @ LO = 4 dBm**

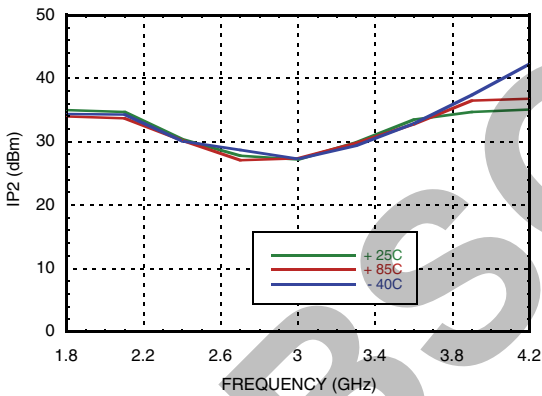

**Input IP2 vs. LO Drive**

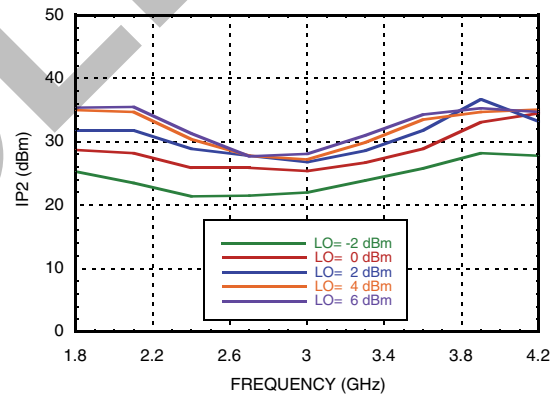

**Input P1dB vs. Temperature @ LO = 4 dBm**

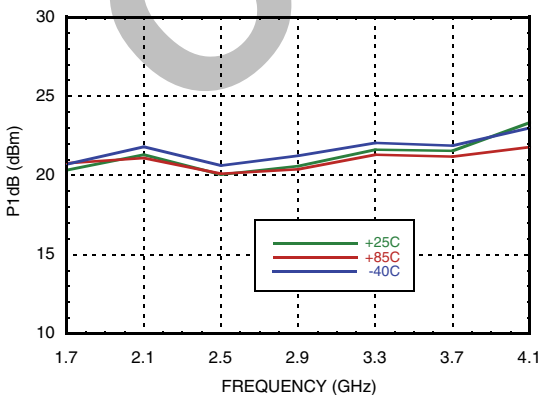

**MxN Spurious @ IF Port**

| mRF | nLO |     |     |     |     |
|-----|-----|-----|-----|-----|-----|
|     | 0   | 1   | 2   | 3   | 4   |
| 0   | xx  | -11 | -1  | 6   | 10  |
| 1   | 5   | 0   | 16  | 37  | 36  |
| 2   | 58  | 67  | 55  | 51  | 60  |
| 3   | 98  | 102 | 103 | 82  | 91  |
| 4   | 99  | 99  | 104 | 106 | 107 |

RF Freq. = 3 GHz @ -10 dBm  
 LO Freq. = 2.8 GHz @ 0 dBm  
 All values in dBc relative to the IF power level.



# HMC615LP4 / 615LP4E

## GaAs MMIC MIXER w/ INTEGRATED LO AMPLIFIER, 2.3 - 4.0 GHz

### Absolute Maximum Ratings

|   |               |
|---|---------------|
| RF / IF Input (Vcc= +5V)  | +27 dBm       |
| LO Drive (Vcc= +5V)   | +10 dBm       |
| BIAS  | +7 Vdc        |
| Junction Temperature  | 150°C         |
| Continuous P <sub>diss</sub> (T = 85°C)<br>(derate 5.21 mW/°C above 85°C) | 0.339 W       |
| Thermal Resistance<br>(junction to ground paddle)                         | 192 °C/W      |
| Storage Temperature   | -65 to +150°C |
| Operating Temperature   | -40 to +85°C  |

### Harmonics of LO

| LO Freq. (GHz) | nLO Spur @ RF Port |    |    |    |
|----------------|--------------------|----|----|----|
|                | 1                  | 2  | 3  | 4  |
| 1              | 8                  | 13 | 29 | 31 |
| 1.8            | 5                  | 23 | 18 | 34 |
| 2.6            | 11                 | 12 | 27 | 30 |
| 3.4            | 15                 | 16 | 48 | 27 |
| 4.2            | 7                  | 18 | 27 | 27 |
| 5              | 16                 | 27 | 38 | 43 |

LO = 0 dBm  
All values in dBc below input LO level measured at RF port.



**ELECTROSTATIC SENSITIVE DEVICE  
OBSERVE HANDLING PRECAUTIONS**

### Typical Supply Current

| Vcc  | Icc (mA) |
|------|----------|
| +5.0 | 65 mA    |

### Outline Drawing

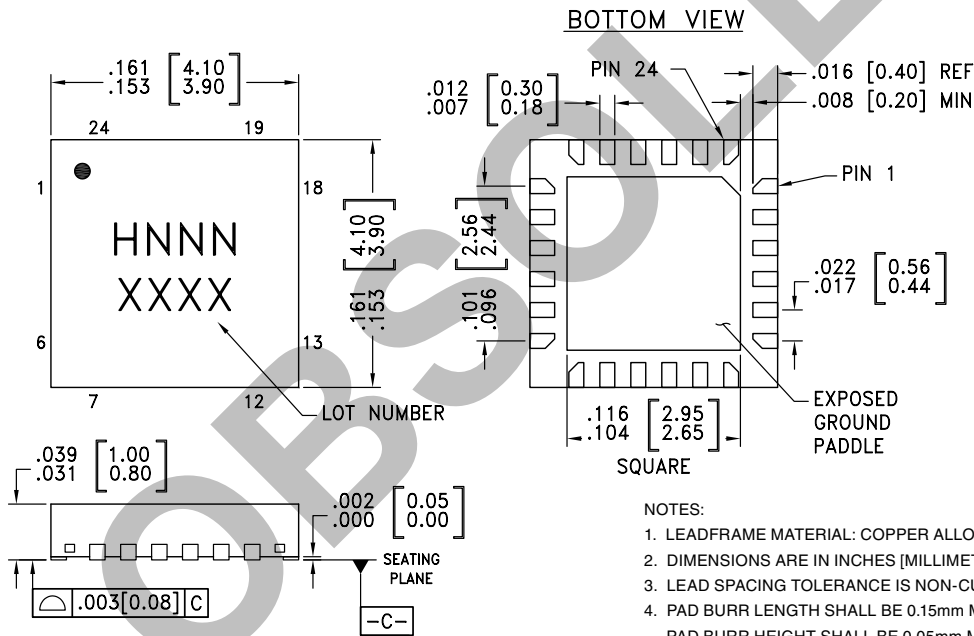

#### NOTES:

- LEADFRAME MATERIAL: COPPER ALLOY
- DIMENSIONS ARE IN INCHES [MILLIMETERS]
- LEAD SPACING TOLERANCE IS NON-CUMULATIVE.
- PAD BURR LENGTH SHALL BE 0.15mm MAXIMUM.  
PAD BURR HEIGHT SHALL BE 0.05mm MAXIMUM.
- PACKAGE WARP SHALL NOT EXCEED 0.05mm.
- ALL GROUND LEADS AND GROUND PADDLE MUST BE SOLDERED TO PCB RF GROUND.
- REFER TO HITTITE APPLICATION NOTE FOR SUGGESTED LAND PATTERN.

### Package Information

| Part Number | Package Body Material                              | Lead Finish   | MSL Rating          | Package Marking <sup>[3]</sup> |
|-------------|--|---------------|---------------------|--------------------------------|
| HMC615LP4   | Low Stress Injection Molded Plastic <sup>[4]</sup> | Sn/Pb Solder  | MSL1 <sup>[1]</sup> | H615<br>XXXX                   |
| HMC615LP4E  | RoHS-compliant Low Stress Injection Molded Plastic | 100% matte Sn | MSL1 <sup>[2]</sup> | H615<br>XXXX                   |

[1] Max peak reflow temperature of 235 °C

[2] Max peak reflow temperature of 260 °C

[3] 4-Digit lot number XXXX

[4] For availability of Non-RoHS HMC615LP4 products please contact Hittite Microwave sales directly.

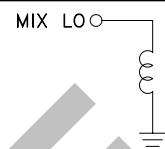
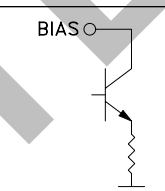
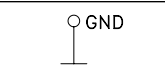
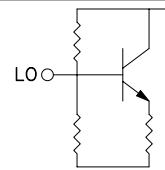
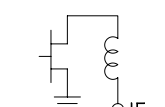
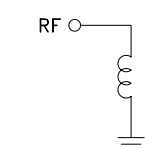

### Pin Descriptions

| Pin Number                 | Function | Description  | Interface Schematic   |
|----------------------------|----------|--|---|
| 1                          | MIX LO   | This pin is DC coupled and matched to 50 Ohms. An off chip DC blocking capacitor is required.  |    |
| 2, 6 - 9, 11 - 17, 19 - 24 | N/C      | No connection. These pins may be connected to RF ground. Performance will not be affected.   |   |
| 3                          | BIAS     | Power supply for the LO amplifier, a Bias resistor is required. Three external bypass capacitors are recommended for optimum performance, as illustrated in the application circuit.   |    |
| 4                          | GND      | Backside of package has exposed metal ground paddle that must also be connected to ground.   |    |
| 5                          | LO       | This pin is DC coupled and matched to 50 Ohms. An off chip DC blocking capacitor is required.  |   |
| 10                         | IF       | This pin is DC coupled. For applications not requiring operation to DC, this port should be DC blocked externally using a series capacitor whose value has been chosen to pass the necessary IF frequency range. For operation to DC, this pin must not source/sink more than 18 mA of current or die non-function and possible die failure will result. |  |
| 18                         | RF       | This pin is DC coupled and matched to 50 Ohms.   |  |

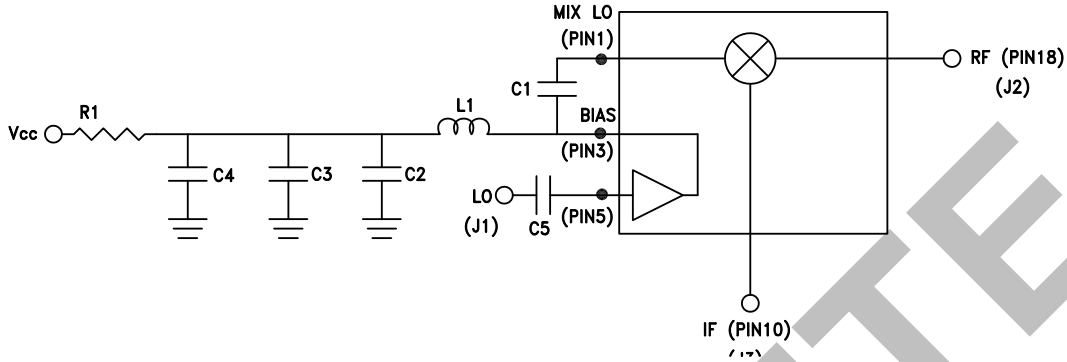
**Application Circuit**

**Evaluation PCB**

**Recommended Components Values (IF = DC - 300 MHz)**

| Component  | Value   |
|------------|---------|
| C3         | 1000 pF |
| C4         | 2.2 μF  |
| C1, C2, C5 | 100 pF  |
| L1         | 18 nH   |
| R1         | 18 Ohm  |

**Note :**

Select R1 to achieve I<sub>cc</sub> by using equation below,  
R1 ≥ 18 Ohms.

$$I_{cc} = (V_s - 3.8) / R_1$$

**List of Materials for Evaluation PCB 115906 [1]**

| Item       | Description                         |
|------------|-------------------------------------|
| J1 - J3    | PCB Mount SMA RF Connector          |
| J4, J5     | DC Pin                              |
| C1, C2, C5 | 100 pF Chip Capacitor, 0402 Pkg.    |
| C3         | 1000 pF Chip Capacitor, 0603 Pkg.   |
| C4         | 2.2 μF Capacitor, Tantalum          |
| L1         | 18 nH Chip Inductor, 0603 Pkg.      |
| R1         | 18 Ohm Resistor, 1210 1/8 watt Pkg. |
| U1         | HMC615LP4E                          |
| PCB [2]    | 113417 Evaluation Board             |

[1] Reference this number when ordering complete evaluation PCB

[2] Circuit Board Material: Rogers 4350

The circuit board used in the application should use RF circuit design techniques. Signal lines should have 50 Ohm impedance while the package ground leads and exposed paddle should be connected directly to the ground plane similar to that shown. A sufficient number of via holes should be used to connect the top and bottom ground planes. The evaluation circuit board shown is available from Hittite upon request.

## Looking for pricing, stock, or lifecycle information?

Click below to explore more details on WIN SOURCE:

 [View HMC615LP4E on WIN SOURCE](#)

 [Analog Devices Inc. Information](#)

## Optimize Your Supply Chain with WIN SOURCE Solutions

-  Global Sourcing Solution
-  Obsolete Management
-  Cost Control Management
-  Shortage Management
-  Alternative Solution
-  Excess Inventory Management