



**THE DATASHEET OF
SA606D/01,112**



SA606

Low-voltage high performance mixer FM IF system

Rev. 6 — 8 November 2013

Product data sheet

1. General description

The SA606 is a low-voltage high performance monolithic FM IF system incorporating a mixer/oscillator, two limiting intermediate frequency amplifiers, quadrature detector, logarithmic Received Signal Strength Indicator (RSSI), voltage regulator and audio and RSSI op amps. The SA606 is available in SO20 and SSOP20 packages.

The SA606 was designed for portable communication applications and will function down to 2.7 V. The RF section is similar to the famous SA605. The audio and RSSI outputs have amplifiers with access to the feedback path. This enables the designer to adjust the output levels or add filtering.

2. Features and benefits

- Low power consumption: 3.5 mA typical at 3 V
- Mixer input to >150 MHz
- Mixer conversion power gain of 17 dB at 45 MHz
- XTAL oscillator effective to 150 MHz (LC oscillator or external oscillator can be used at higher frequencies)
- 102 dB of IF amp/limiter gain
- 2 MHz IF amp/limiter small signal bandwidth
- Temperature compensated logarithmic RSSI with a 90 dB dynamic range
- Low external component count; suitable for crystal/ceramic/LC filters
- Excellent sensitivity: 0.31 μ V into 50 Ω matching network for 12 dB SINAD (Signal-to-Noise-and-Distortion ratio) for 1 kHz tone with RF at 45 MHz and IF at 455 kHz
- SA606 meets cellular radio specifications
- Audio output internal op amp
- RSSI output internal op amp
- Internal op amps with rail-to-rail outputs
- ESD protection exceeds 2000 V HBM per JESD22-A114 and 1000 V CDM per JESD22-C101
- Latch-up testing is done to JEDEC Standard JESD78 Class II, Level B

3. Applications

- Portable cellular radio FM IF
- Cordless phones
- Wireless systems
- RF level meter



- Spectrum analyzer
- Instrumentation
- FSK and ASK data receivers
- Log amps
- Portable high performance communication receiver
- Single conversion VHF receivers

4. Ordering information

Table 1. Ordering information

$T_{amb} = -40\text{ °C to }+85\text{ °C}$

Type number	Topside mark	Package		Version
		Name	Description	
SA606D/01	SA606D	SO20	plastic small outline package; 20 leads; body width 7.5 mm	SOT163-1
SA606DK/01	SA606DK	SSOP20	plastic shrink small outline package; 20 leads; body width 4.4 mm	SOT266-1
SA606DK/02	SA606DK	SSOP20	plastic shrink small outline package; 20 leads; body width 4.4 mm	SOT266-1
SA606DK/03	SA606DK	SSOP20	plastic shrink small outline package; 20 leads; body width 4.4 mm	SOT266-1

4.1 Ordering options

Table 2. Ordering options

Type number	Orderable part number	Package	Packing method	Minimum order quantity	Temperature
SA606D/01	SA606D/01,112	SO20	Standard marking *IC's tube - DSC bulk pack	1520	$T_{amb} = -40\text{ °C to }+85\text{ °C}$
	SA606D/01,118	SO20	Reel 13" Q1/T1 *Standard mark SMD	2000	$T_{amb} = -40\text{ °C to }+85\text{ °C}$
SA606DK/01	SA606DK/01,112	SSOP20	Standard marking *IC's tube - DSC bulk pack	1350	$T_{amb} = -40\text{ °C to }+85\text{ °C}$
	SA606DK/01,118	SSOP20	Reel 13" Q1/T1 *Standard mark SMD	2500	$T_{amb} = -40\text{ °C to }+85\text{ °C}$
SA606DK/02	SA606DK/02,118	SSOP20	Reel 13" Q1/T1 *Standard mark SMD	2500	$T_{amb} = -40\text{ °C to }+85\text{ °C}$
SA606DK/03	SA606DK/03,118	SSOP20	Reel 13" Q1/T1 *Standard mark SMD	2500	$T_{amb} = -40\text{ °C to }+85\text{ °C}$

5. Block diagram

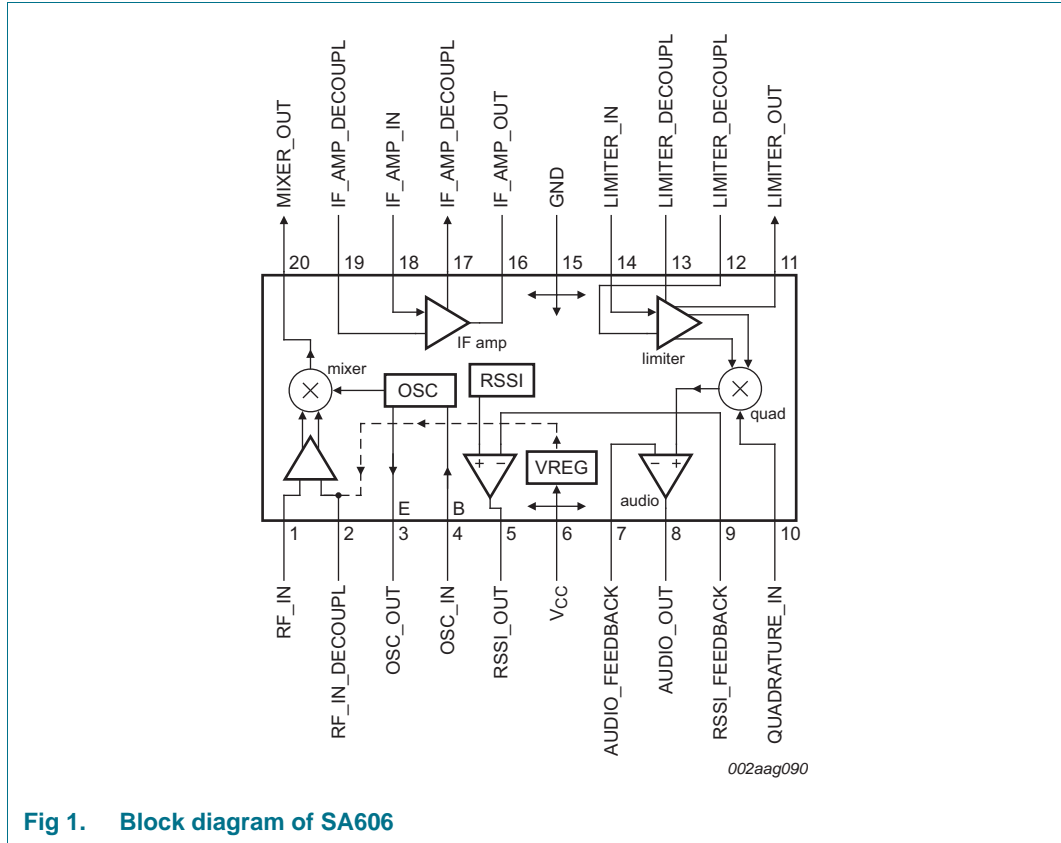

Fig 1. Block diagram of SA606

6. Pinning information

6.1 Pinning

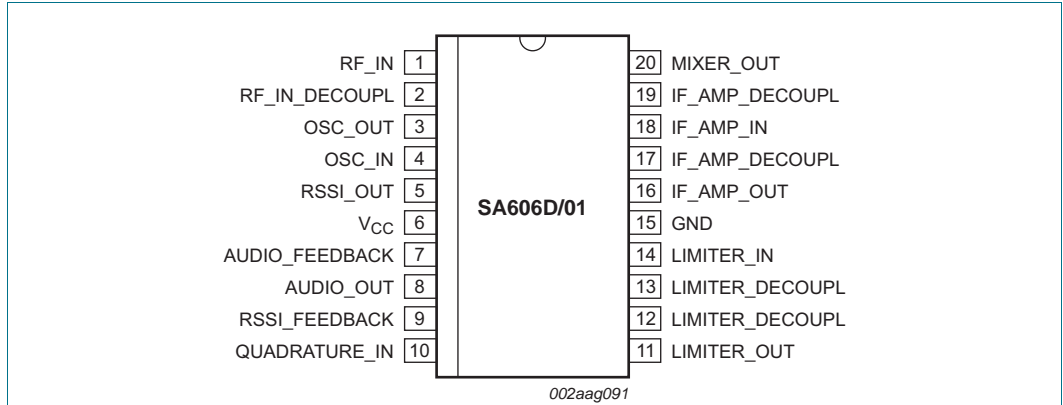

Fig 2. Pin configuration for SO20

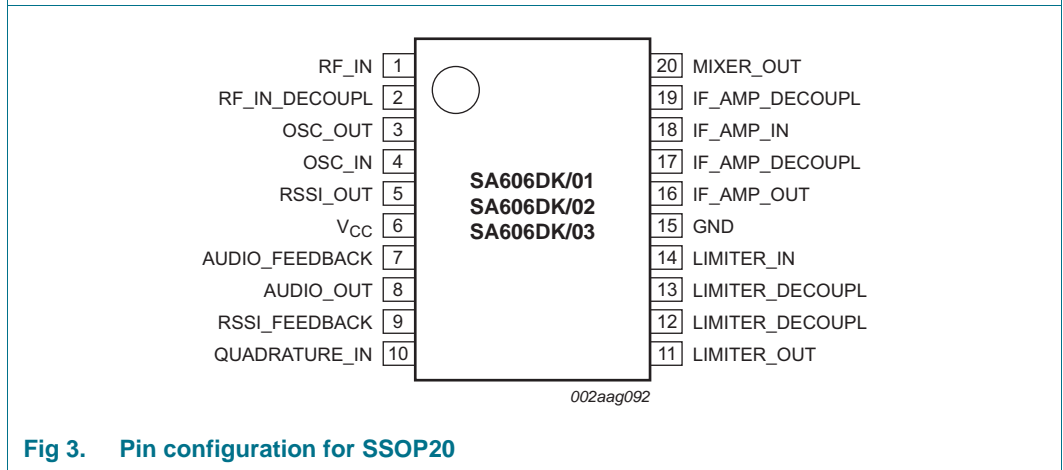

Fig 3. Pin configuration for SSOP20

6.2 Pin description

Table 3. Pin description

Symbol	Pin	Description
RF_IN	1	RF input
RF_IN_DECOUPL	2	RF input decoupling pin
OSC_OUT	3	oscillator output
OSC_IN	4	oscillator input
RSSI_OUT	5	RSSI output
V _{CC}	6	positive supply voltage
AUDIO_FEEDBACK	7	audio amplifier negative feedback terminal
AUDIO_OUT	8	audio amplifier output
RSSI_FEEDBACK	9	RSSI amplifier negative feedback terminal
QUADRATURE_IN	10	quadrature detector input terminal
LIMITER_OUT	11	limiter amplifier output
LIMITER_DECOUPL	12	limiter amplifier decoupling pin
LIMITER_DECOUPL	13	limiter amplifier decoupling pin
LIMITER_IN	14	limiter amplifier input
GND	15	ground; negative supply
IF_AMP_OUT	16	IF amplifier output
IF_AMP_DECOUPL	17	IF amplifier decoupling pin
IF_AMP_IN	18	IF amplifier input
IF_AMP_DECOUPL	19	IF amplifier decoupling pin
MIXER_OUT	20	mixer output

7. Functional description

The SA606 is an IF signal processing system suitable for second IF systems with input frequency as high as 150 MHz. The bandwidth of the IF amplifier and limiter is at least 2 MHz with 90 dB of gain. The gain/bandwidth distribution is optimized for 455 kHz, 1.5 k Ω source applications. The overall system is well-suited to battery operation as well as high performance and high quality products of all types.

The input stage is a Gilbert cell mixer with oscillator. Typical mixer characteristics include a noise figure of 6.2 dB, conversion gain of 17 dB, and input third-order intercept of -9 dBm. The oscillator will operate in excess of 200 MHz in L/C tank configurations. Hartley or Colpitts circuits can be used up to 100 MHz for crystal configurations. Butler oscillators are recommended for crystal configurations up to 150 MHz.

The output impedance of the mixer is a 1.5 k Ω resistor permitting direct connection to a 455 kHz ceramic filter. The input resistance of the limiting IF amplifiers is also 1.5 k Ω . With most 455 kHz ceramic filters and many crystal filters, no impedance matching network is necessary. The IF amplifier has 43 dB of gain and 5.5 MHz bandwidth. The IF limiter has 60 dB of gain and 4.5 MHz bandwidth.

To achieve optimum linearity of the log signal strength indicator, there must be a 12 dBV insertion loss between the first and second IF stages. If the IF filter or interstage network does not cause 12 dBV insertion loss, a fixed or variable resistor or an L pad for simultaneous loss and impedance matching can be added between the first IF output (IF_AMP_OUT) and the interstage network. The overall gain will then be 90 dB with 2 MHz bandwidth.

The signal from the second limiting amplifier goes to a Gilbert cell quadrature detector. One port of the Gilbert cell is internally driven by the IF. The other output of the IF is AC-coupled to a tuned quadrature network. This signal, which now has a 90° phase relationship to the internal signal, drives the other port of the multiplier cell.

The demodulated output of the quadrature drives an internal op amp. This op amp can be configured as a unity gain buffer, or for simultaneous gain, filtering, and second-order temperature compensation if needed. It can drive an AC load as low as 5 k Ω with a rail-to-rail output.

A log signal strength indicator completes the circuitry. The output range is greater than 90 dB and is temperature compensated. This log signal strength indicator exceeds the criteria for AMPS or TACS cellular telephone. This signal drives an internal op amp. The op amp is capable of rail-to-rail output. It can be used for gain, filtering, or second-order temperature compensation of the RSSI, if needed.

Remark: $\text{dBV} = 20\log V_O/V_I$.

8. Limiting values

Table 4. Limiting values

In accordance with the Absolute Maximum Rating System (IEC 60134).

Symbol	Parameter	Conditions	Min	Max	Unit
V_{CC}	supply voltage		-	7	V
T_{stg}	storage temperature		-65	+150	°C
T_{amb}	ambient temperature	operating	-40	+85	°C

9. Thermal characteristics

Table 5. Thermal characteristics

Symbol	Parameter	Conditions	Max	Unit
$Z_{th(j-a)}$	transient thermal impedance from junction to ambient	SA606D/01 (SO20)	90	K/W
		SA606DK/01, SA606DK/02, SA606DK/03 (SSOP20)	117	K/W

10. Static characteristics

Table 6. Static characteristics

$V_{CC} = 3\text{ V}$; $T_{amb} = 25\text{ °C}$; unless specified otherwise.

Symbol	Parameter	Conditions	Min	Typ	Max	Unit
V_{CC}	supply voltage		2.7	-	7.0	V
I_{CC}	supply current		-	3.5	4.2	mA

11. Dynamic characteristics

Table 7. Dynamic characteristics

$T_{amb} = 25\text{ }^{\circ}\text{C}$; $V_{CC} = 3\text{ V}$; unless specified otherwise. RF frequency = 45 MHz + 14.5 dBV RF input step-up. IF frequency = 455 kHz; $R_{17} = 2.4\text{ k}\Omega$ and $R_{18} = 3.3\text{ k}\Omega$. RF level = -45 dBm; FM modulation = 1 kHz with $\pm 8\text{ kHz}$ peak deviation. Audio output with de-emphasis filter and C-message weighted filter. Test circuit [Figure 19](#). The parameters listed below are tested using automatic test equipment to assure consistent electrical characteristics. The limits do not represent the ultimate performance limits of the device. Use of an optimized RF layout will improve many of the listed parameters.

Symbol	Parameter	Conditions	Min	Typ	Max	Unit
Mixer/oscillator section (external LO = 220 mV RMS value)						
f_i	input frequency		-	150	-	MHz
f_{osc}	oscillator frequency		-	150	-	MHz
NF	noise figure	at 45 MHz	-	6.2	-	dB
IP _{3i}	input third-order intercept point	50 Ω source; f1 = 45.0 MHz; f2 = 45.06 MHz; input RF level = -52 dBm	-	-9	-	dB
$G_{p(conv)}$	conversion power gain	matched 14.5 dBV step-up	13.5	17	19.5	dB
		50 Ω source	-	2.5	-	dB
$R_{i(RF)}$	RF input resistance	single-ended input	-	8	-	k Ω
$C_{i(RF)}$	RF input capacitance		-	3.0	4.0	pF
$R_{o(mix)}$	mixer output resistance	MIXER_OUT pin	1.25	1.5	-	k Ω
IF section						
$G_{amp(IF)}$	IF amplifier gain	50 Ω source	-	44	-	dB
G_{lim}	limiter gain	50 Ω source	-	58	-	dB
$P_{i(IF)}$	IF input power	for -3 dB input limiting sensitivity; $R_{17} = 2.4\text{ k}\Omega$; $R_{18} = 3.3\text{ k}\Omega$ (Figure 19); test at IF_AMP_IN pin	-	-109	-	dBm
α_{AM}	AM rejection	80 % AM 1 kHz	-	45	-	dB
$V_{o(aud)}$	audio output voltage	gain of two (2 k Ω AC load)	70	120	160	mV
SINAD	signal-to-noise-and-distortion ratio	IF level -110 dBm	-	17	-	dB
THD	total harmonic distortion		-35	-50	-	dB
S/N	signal-to-noise ratio	no modulation for noise	-	62	-	dB
$V_{o(RSSI)}$	RSSI output voltage	RF; $R_9 = 2\text{ k}\Omega$				
		RF level = -118 dBm	-	0.3	0.8	V
		SA606D/01, SA606DK/01; RF level = -68 dBm;	0.7	1.1	1.8	V
		SA606DK/02; RF level = -68 dBm	0.95	-	1.05	V
		SA606DK/03; RF level = -68 dBm	1.06	-	1.15	V
		RF level = -23 dBm	1.2	1.8	2.5	V
$\alpha_{RSSI(range)}$	RSSI range		-	90	-	dB
$\Delta\alpha_{RSSI}$	RSSI variation		-	± 1.5	-	dB
$Z_{i(IF)}$	IF input impedance	IF_AMP_IN pin	1.3	1.5	-	k Ω
$Z_{o(IF)}$	IF output impedance	IF_AMP_OUT pin	-	0.3	-	k Ω
$Z_{i(lim)}$	limiter input impedance	LIMITER_IN pin	1.3	1.5	-	k Ω

Table 7. Dynamic characteristics ...continued

$T_{amb} = 25\text{ }^{\circ}\text{C}$; $V_{CC} = 3\text{ V}$; unless specified otherwise. RF frequency = 45 MHz + 14.5 dBV RF input step-up. IF frequency = 455 kHz; $R17 = 2.4\text{ k}\Omega$ and $R18 = 3.3\text{ k}\Omega$. RF level = -45 dBm; FM modulation = 1 kHz with $\pm 8\text{ kHz}$ peak deviation. Audio output with de-emphasis filter and C-message weighted filter. Test circuit [Figure 19](#). The parameters listed below are tested using automatic test equipment to assure consistent electrical characteristics. The limits do not represent the ultimate performance limits of the device. Use of an optimized RF layout will improve many of the listed parameters.

Symbol	Parameter	Conditions	Min	Typ	Max	Unit
$Z_{o(lim)}$	limiter output impedance	LIMITER_OUT pin	-	0.3	-	k Ω
$V_{o(RMS)}$	RMS output voltage	LIMITER_OUT pin	-	130	-	mV
RF/IF section (internal LO)						
$V_{o(aud)RMS}$	RMS audio output voltage	$V_{CC} = 3\text{ V}$; RF level = -27 dBm	-	120	-	mV
$V_{o(RSSI)}$	RSSI output voltage	system; $V_{CC} = 3\text{ V}$; RF level = -27 dBm	-	2.2	-	V
SINAD	signal-to-noise-and-distortion ratio	system; RF level = -117 dBm	-	12	-	dB

12. Performance curves

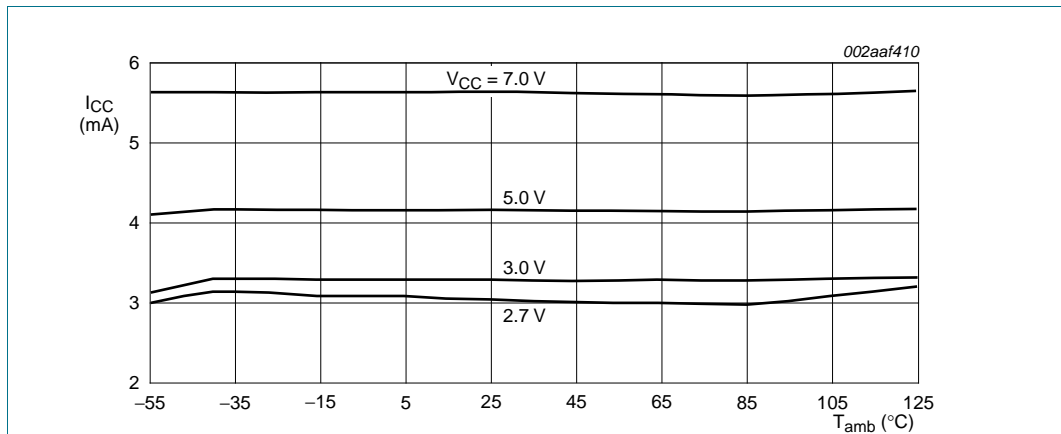

Fig 4. Supply current versus ambient temperature

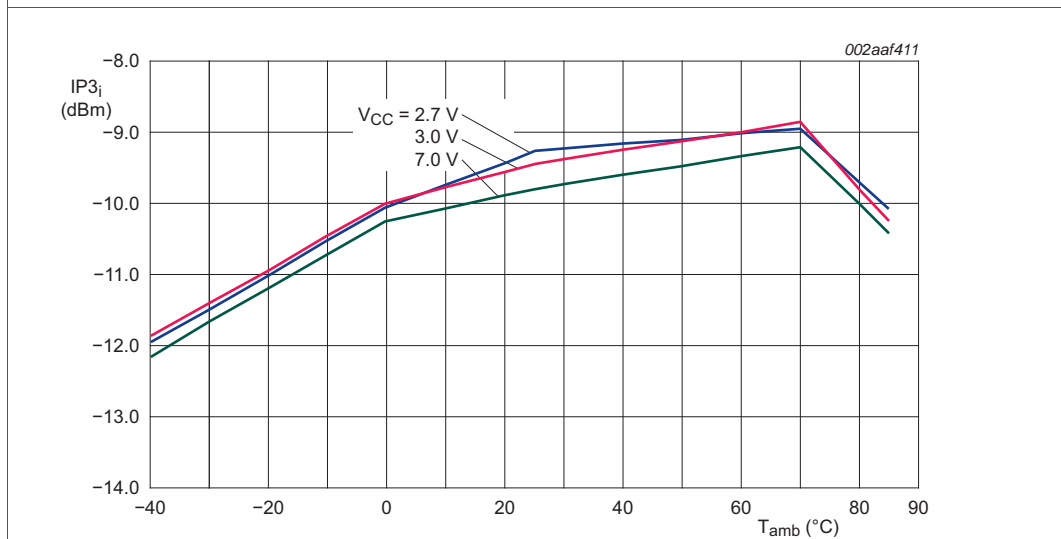

Fig 5. Third order intercept point versus ambient temperature and supply voltage

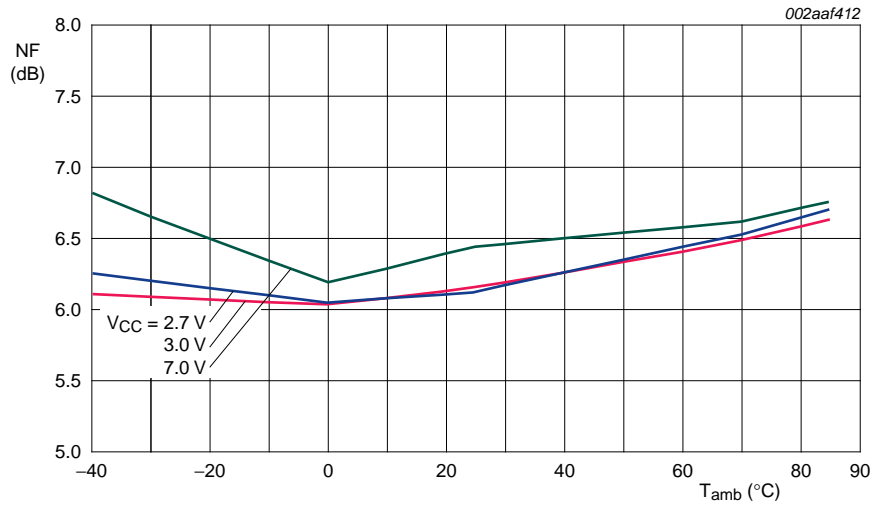

Fig 6. Mixer noise figure versus ambient temperature and supply voltage

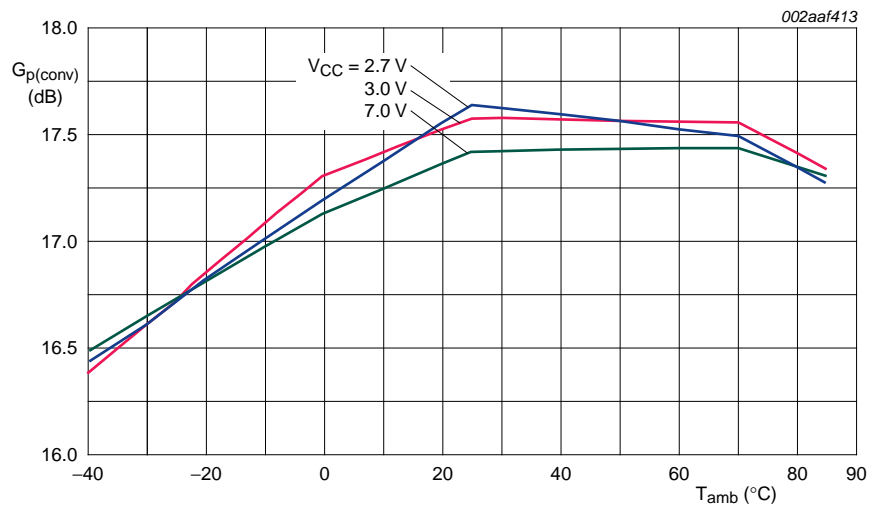
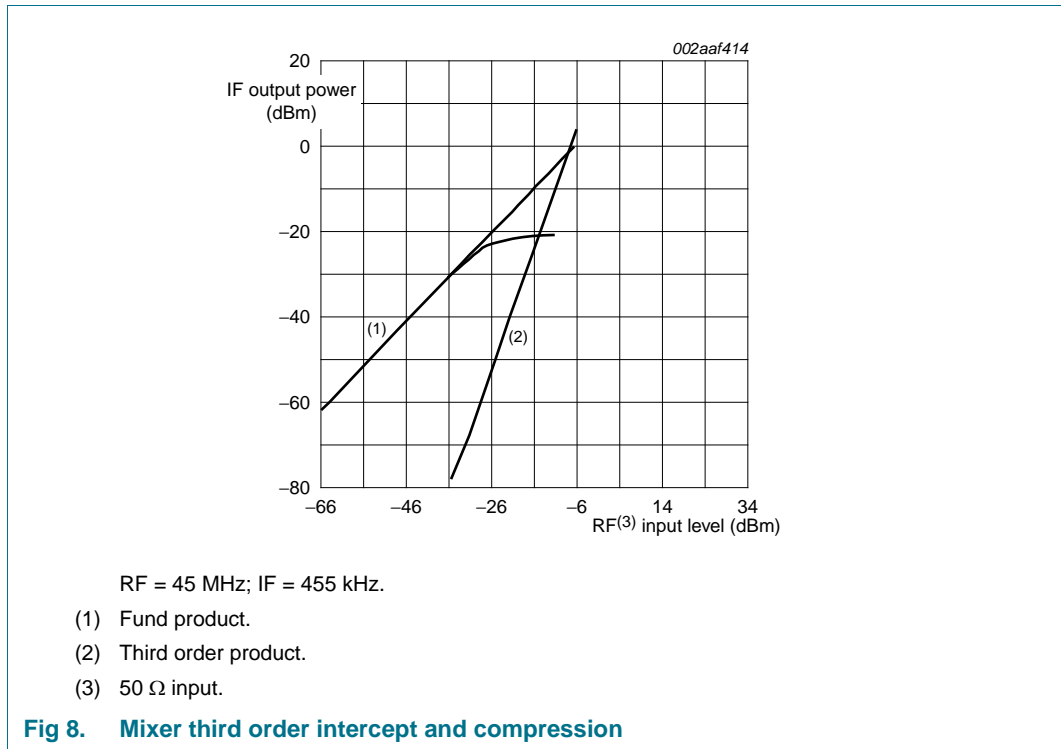
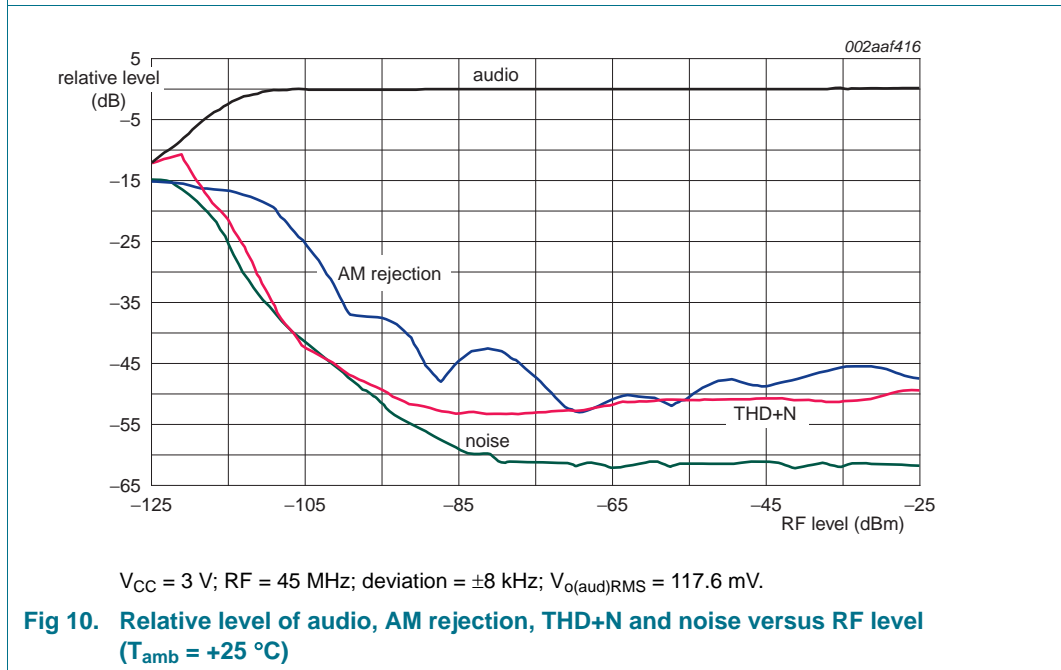
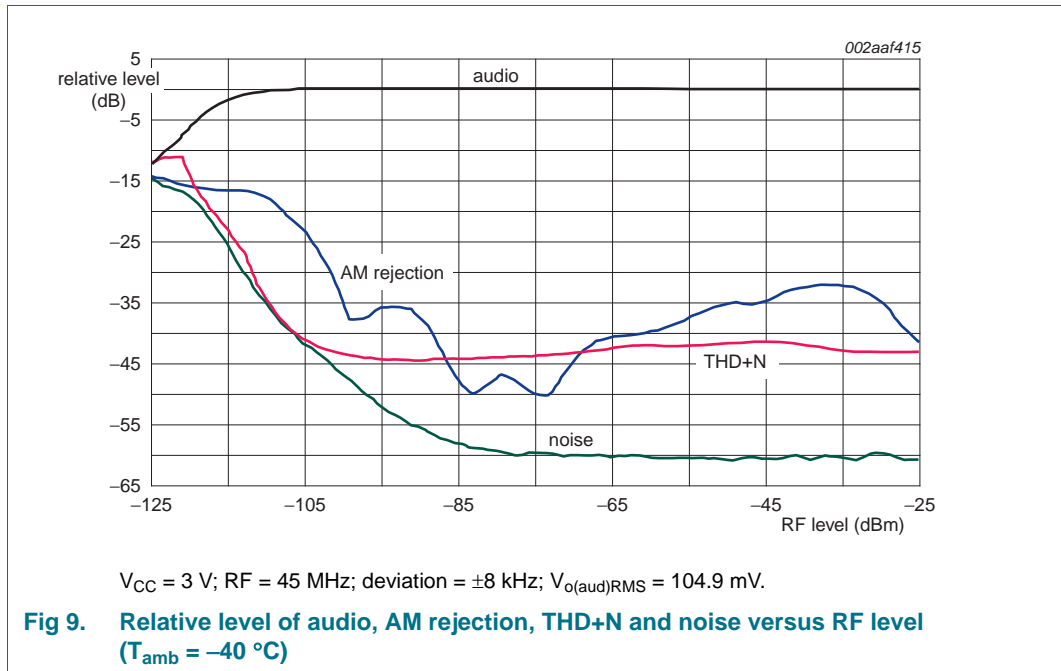
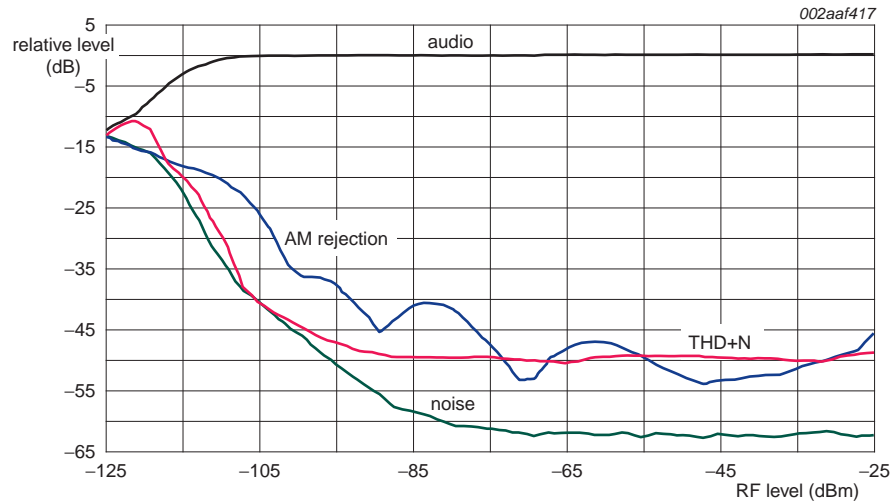

Fig 7. Conversion gain versus ambient temperature and supply voltage







$V_{CC} = 3\text{ V}$; $RF = 45\text{ MHz}$; deviation = $\pm 8\text{ kHz}$; $V_{o(aud)RMS} = 127\text{ mV}$.

Fig 11. Relative level of audio, AM rejection, THD+N and noise versus RF level ($T_{amb} = +85\text{ }^{\circ}\text{C}$)

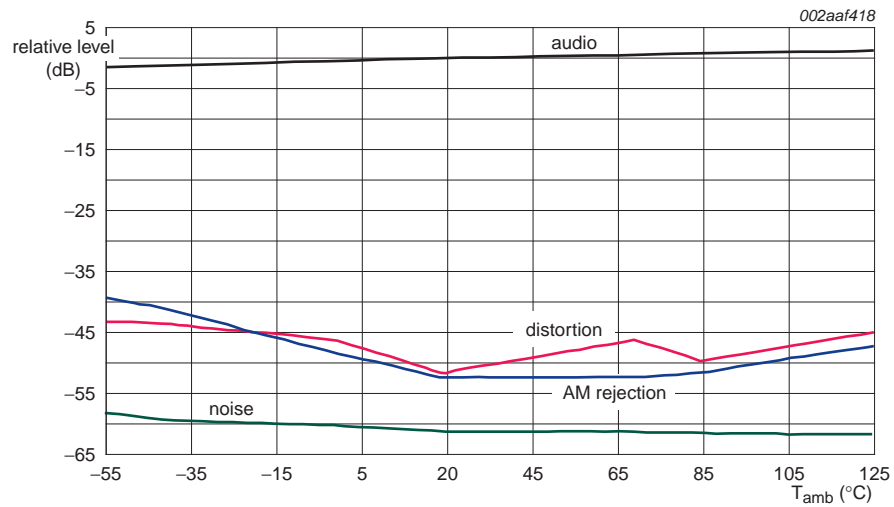

$V_{CC} = 3\text{ V}$; $RF = 45\text{ MHz}$; $RF\text{ level} = -45\text{ dBm}$; deviation = $\pm 8\text{ kHz}$; $V_{o(aud)RMS} = +117.6\text{ mV}$.

Fig 12. Relative audio level, distortion, AM rejection and noise versus ambient temperature

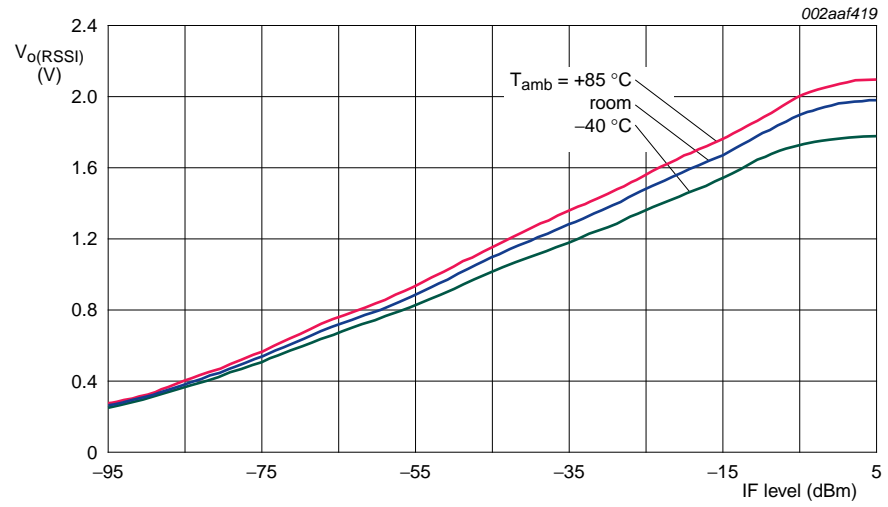

455 kHz IF at 3 V.

Fig 13. RSSI output voltage versus IF level (SA606D/01; SA606DK/01)

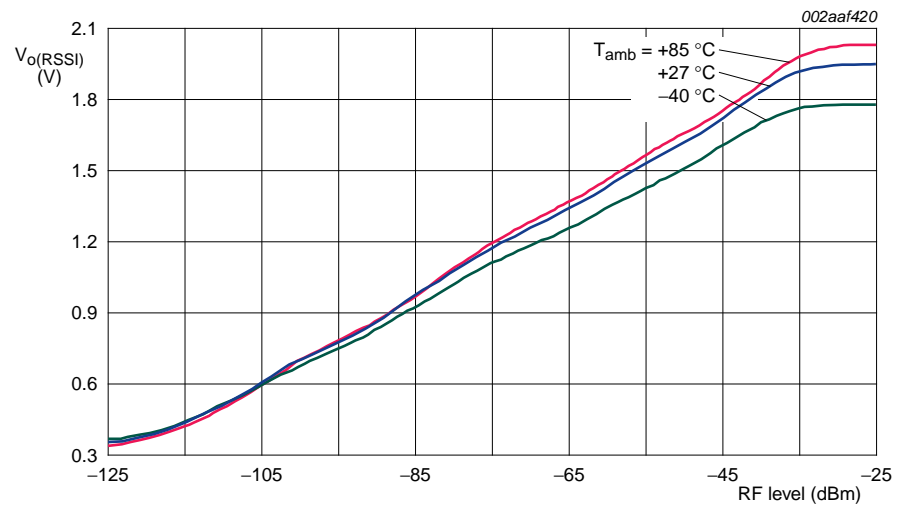

$V_{CC} = 3 V$

Fig 14. RSSI output voltage versus RF level (SA606D/01; SA606DK/01)

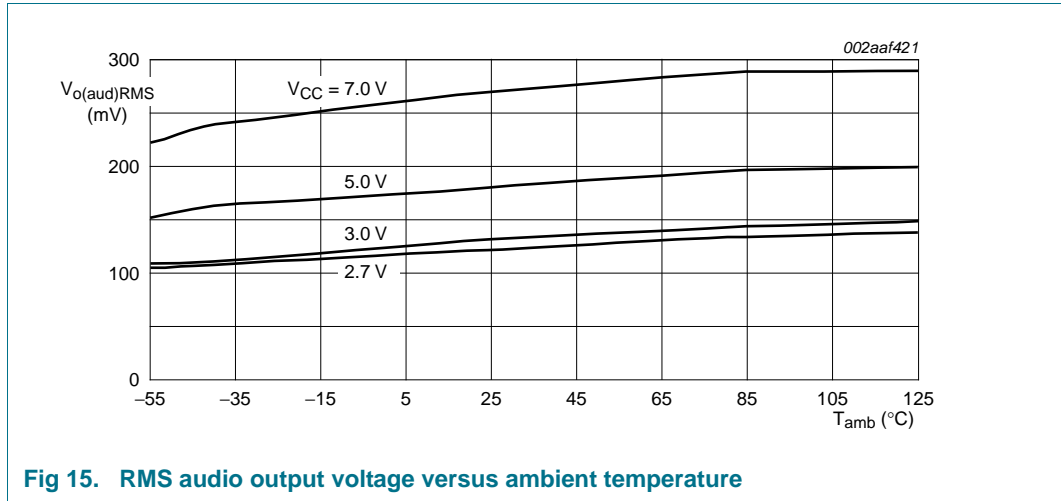
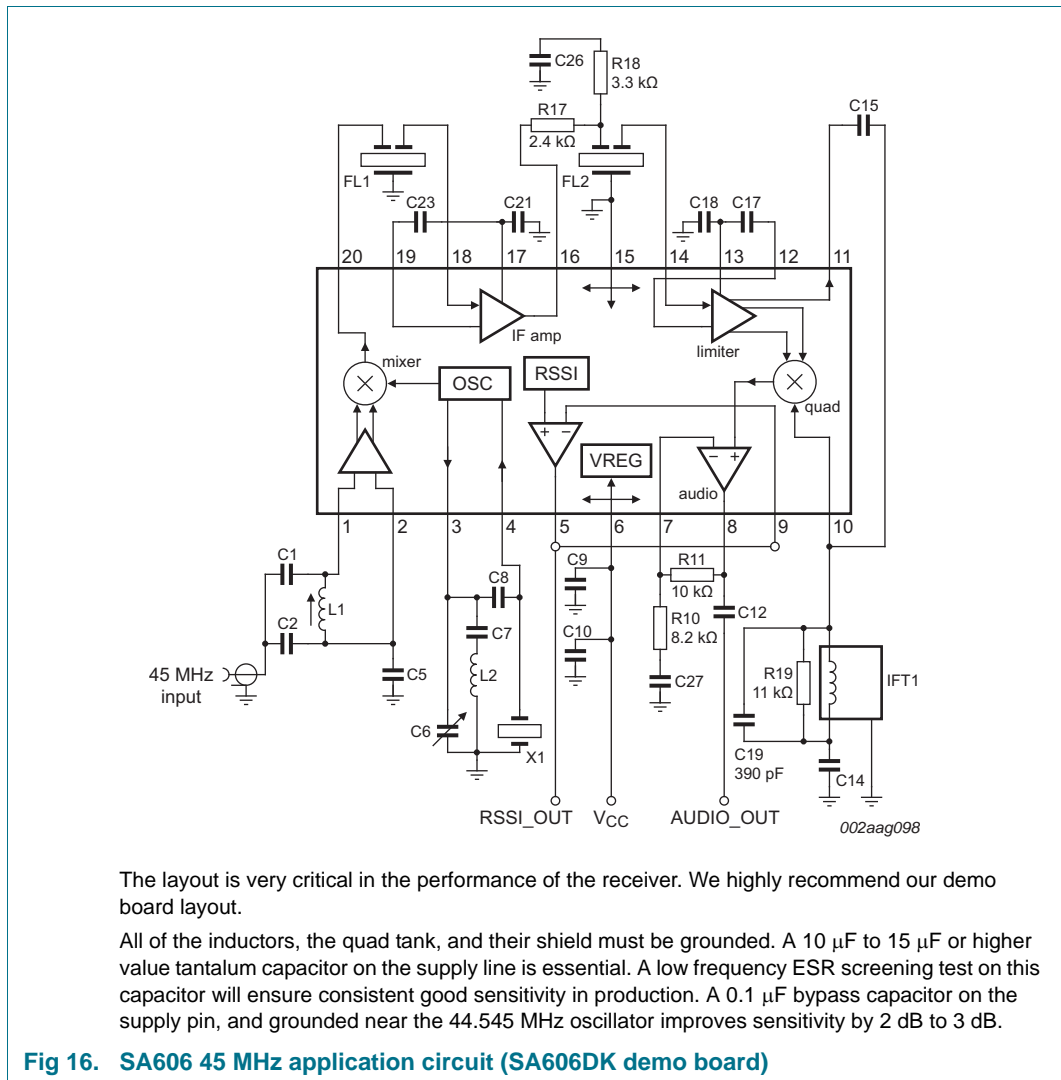

Fig 15. RMS audio output voltage versus ambient temperature

13. Application information



The layout is very critical in the performance of the receiver. We highly recommend our demo board layout.

All of the inductors, the quad tank, and their shield must be grounded. A 10 μF to 15 μF or higher value tantalum capacitor on the supply line is essential. A low frequency ESR screening test on this capacitor will ensure consistent good sensitivity in production. A 0.1 μF bypass capacitor on the supply pin, and grounded near the 44.545 MHz oscillator improves sensitivity by 2 dB to 3 dB.

Fig 16. SA606 45 MHz application circuit (SA606DK demo board)

Table 8. SA606DK demo board component list

Component	Description
C1	51 pF NPO ceramic
C2	220 pF NPO ceramic
C5, C9, C14, C17, C18, C21, C23, C26	100 nF \pm 10 % monolithic ceramic
C6	5 pF to 30 pF trim cap
C7	1 nF ceramic
C8, C15	10.0 pF NPO ceramic
C10	10 μ F tantalum (minimum)
C12	2.2 μ F \pm 10 % tantalum
C19	390 pF \pm 10 % monolithic ceramic
C27	2.2 μ F tantalum
FL1, FL2 ^[1]	ceramic filter Murata CFUKF455KB4X-R0
IFT1	330 μ H Toko 836AN-0129Z
L1	0.33 μ H Toko SCB-1320Z
L2	1.2 μ H
X1	44.545 MHz crystal ICM4712701
R5 ^[2]	not used in application board
R10	8.2 k Ω \pm 5 % 1/4W carbon composition
R11	10 k Ω \pm 5 % 1/4W carbon composition
R17	2.4 k Ω \pm 5 % 1/4W carbon composition
R18	3.3 k Ω \pm 5 % 1/4W carbon composition
R19	11 k Ω \pm 5 % 1/4W carbon composition

[1] This is a 30 kHz bandwidth 455 kHz ceramic filter. All the characterization and testing are done with this wideband filter. A more narrowband 15 kHz bandwidth 455 kHz ceramic filter that may be used as an alternative selection is Murata CFUKG455KE4A-R0.

[2] R5 can be used to bias the oscillator transistor at a higher current for operation above 45 MHz. Recommended value is 10 k Ω .

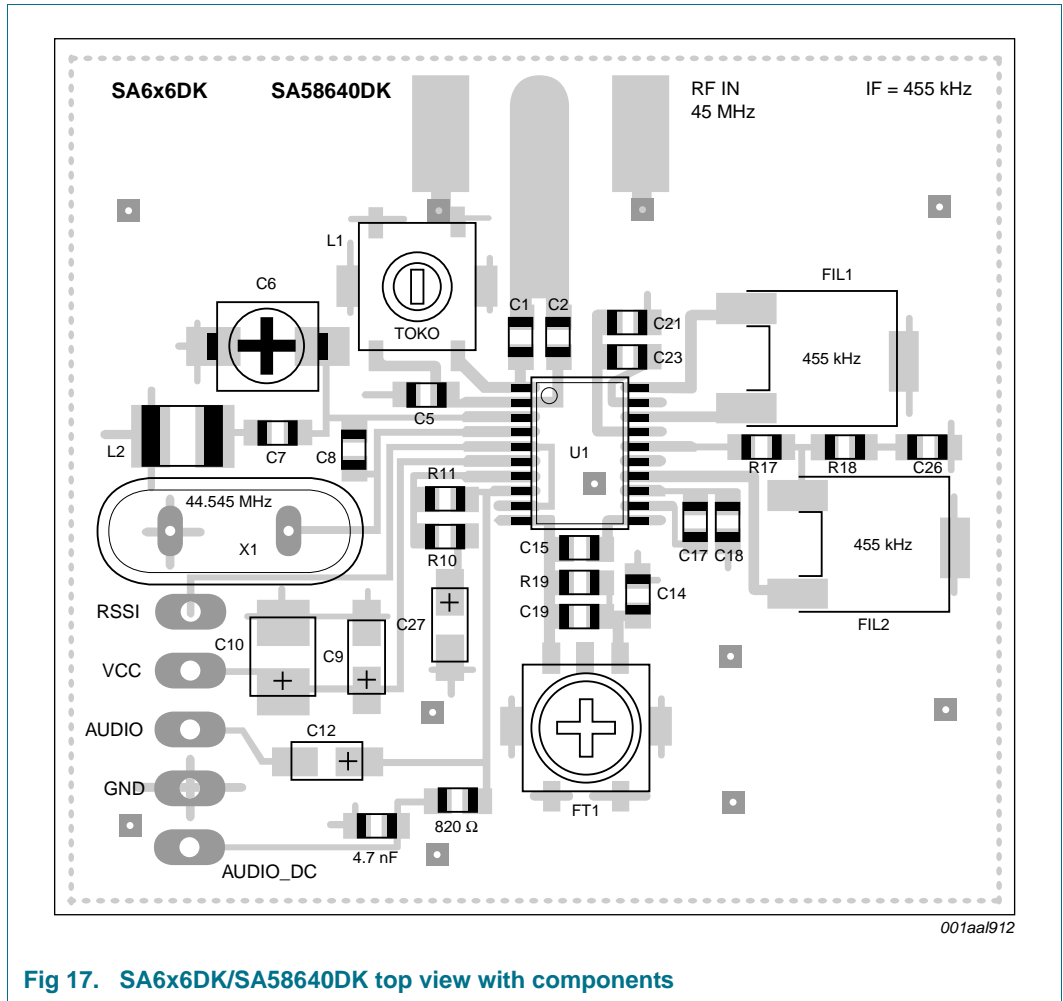
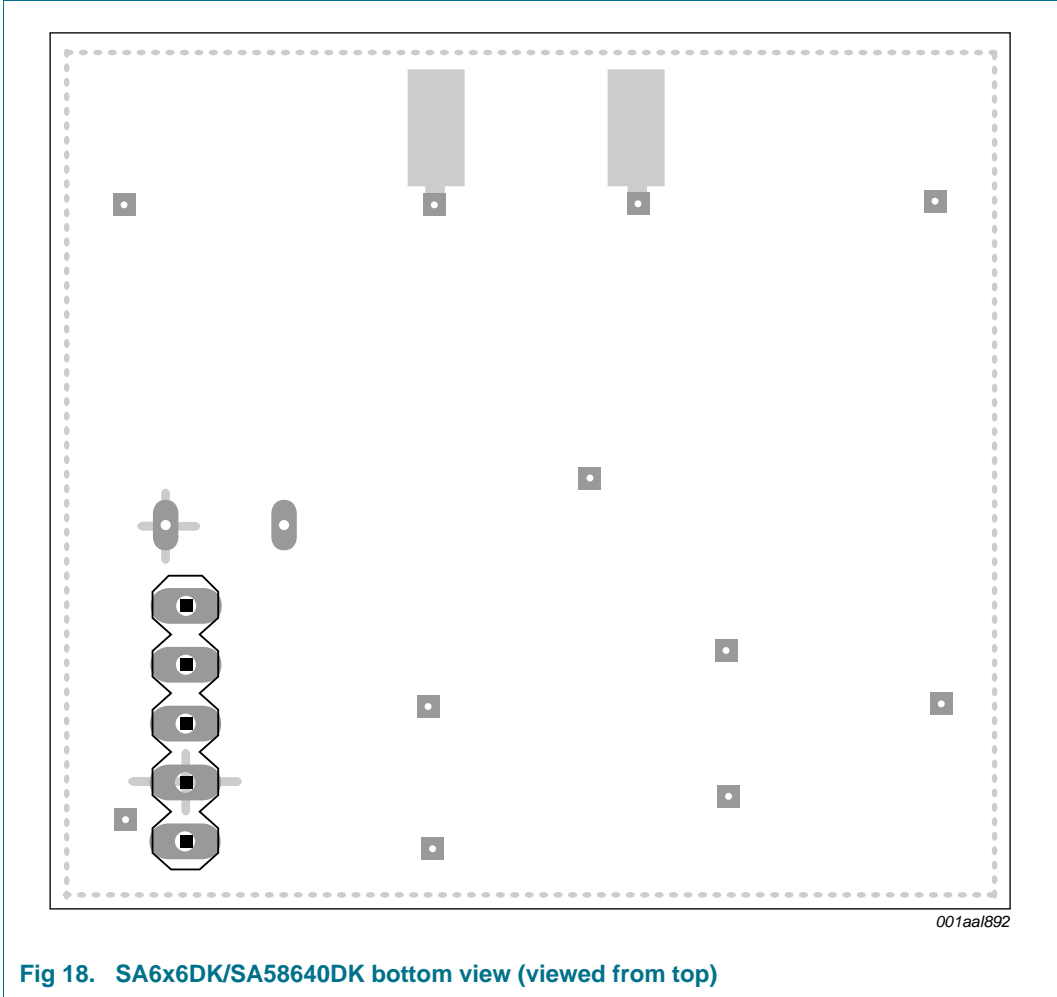

Fig 17. SA6x6DK/SA58640DK top view with components



14. Test information

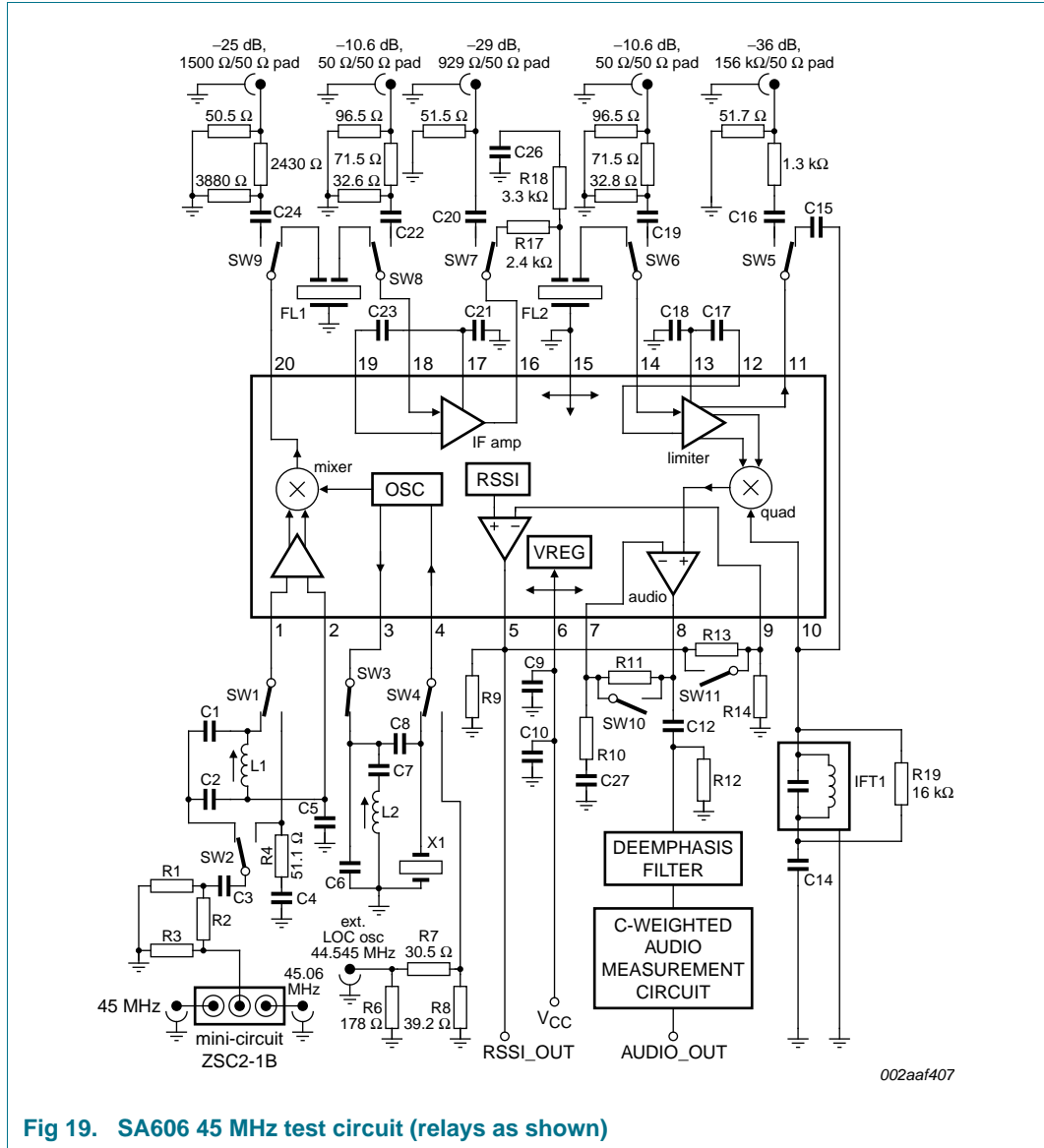

Fig 19. SA606 45 MHz test circuit (relays as shown)

Table 9. Automatic test circuit component list

Component	Description
C1	100 pF NPO ceramic
C2	390 pF NPO ceramic
C5, C9, C14, C17, C18, C21, C23, C25, C26, C27	100 nF \pm 10 % monolithic ceramic
C6	22 pF NPO ceramic
C7	1 nF ceramic
C8, C15	10 pF NPO ceramic
C10	10 μ F ^[1] tantalum (minimum)
C12	2.2 μ F
C27	2.2 μ F \pm 10 % monolithic ceramic
FL1, FL2 ^[2]	ceramic filter Murata CFUKF455KB4X-R0
IFT1	455 kHz (Ce = 180 pF) Toko RMC-2A6597H
L1	147 nH to 160 nH Coilcraft UNI-10/142-04J08S
L2	0.8 μ H nominal; Toko 292CNS-T1038Z
R9	2 k Ω \pm 1 % 1/4 W metal film
R10	10 k Ω \pm 1 %
R11, R14	10 k Ω \pm 1 %
R12	2 k Ω \pm 1 %
R13	20 k Ω \pm 1 %
R17	2.4 k Ω \pm 5 % 1/4 W carbon composition
R18	3.3 k Ω
R19	16 k Ω
X1	44.545 MHz crystal ICM4712701

[1] This value can be reduced when a battery is the power source.

[2] This a 30 kHz bandwidth 455 kHz ceramic filter. All the characterization and testing are done with this wideband filter. A more narrowband 15 kHz bandwidth 455 kHz ceramic filter that may be used as an alternative selection is Murata CFUKG455KE4A-R0.

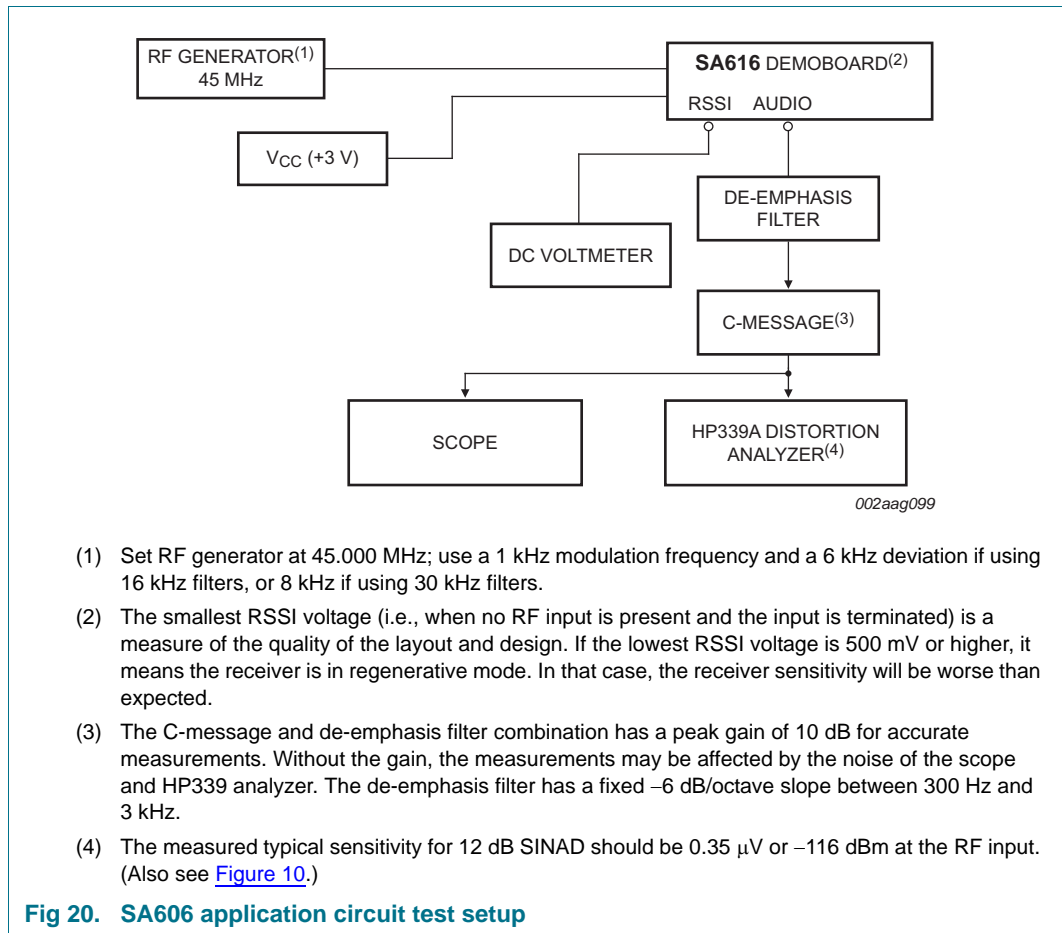

15. Package outline

SO20: plastic small outline package; 20 leads; body width 7.5 mm

SOT163-1

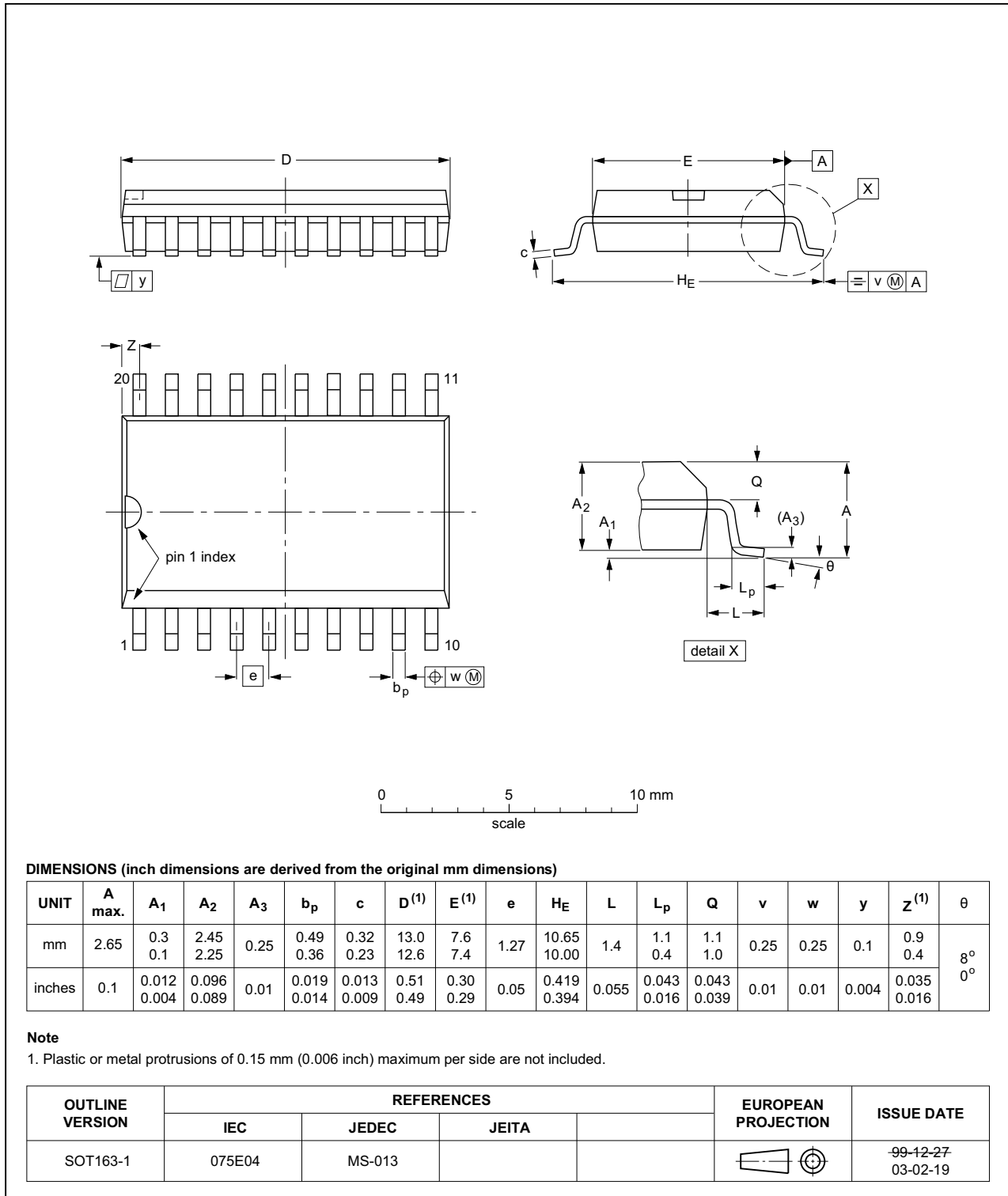

Fig 21. Package outline SOT163-1 (SO20)

SSOP20: plastic shrink small outline package; 20 leads; body width 4.4 mm

SOT266-1

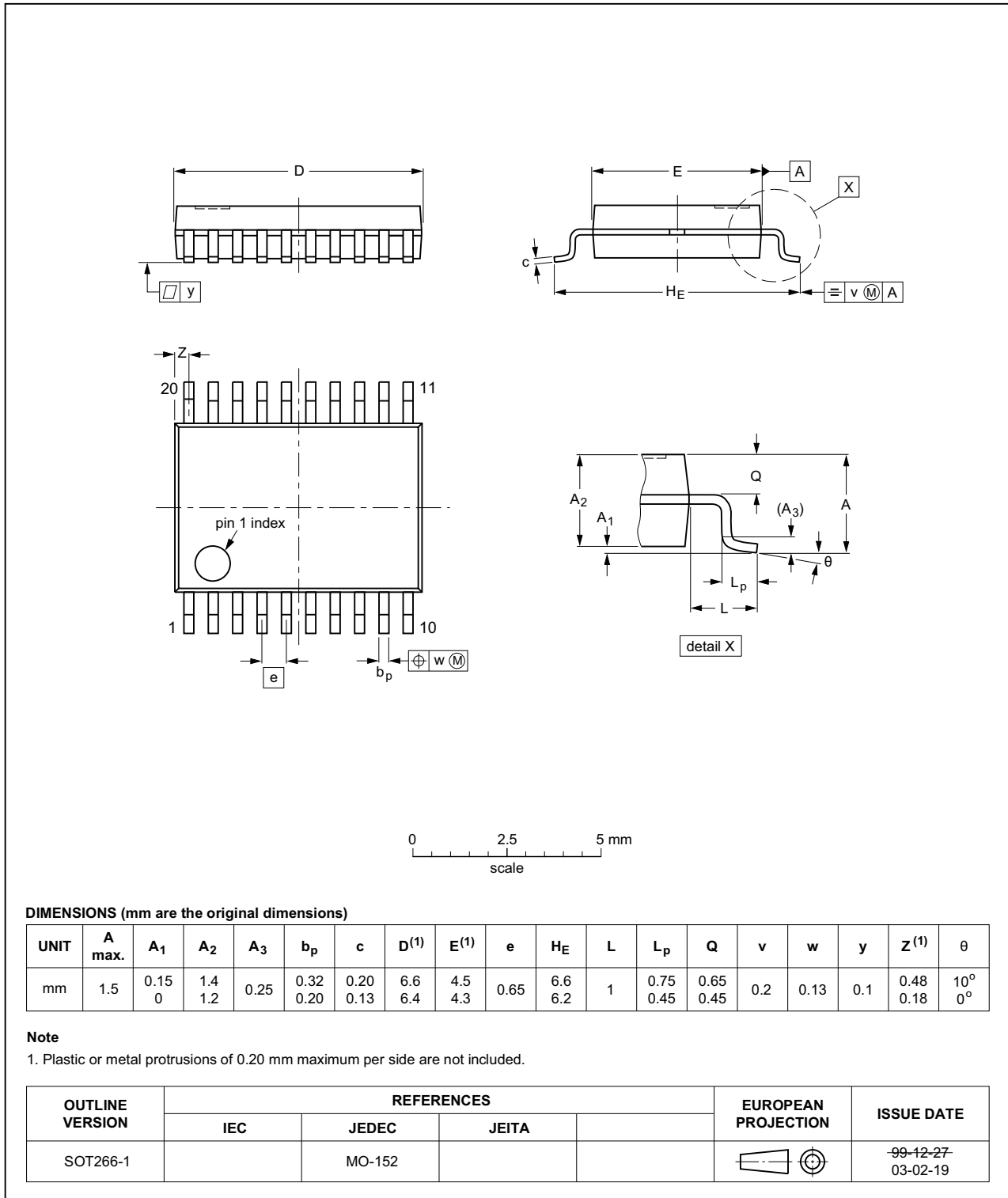

Fig 22. Package outline SOT266-1 (SSOP20)

16. Soldering of SMD packages

This text provides a very brief insight into a complex technology. A more in-depth account of soldering ICs can be found in Application Note *AN10365 "Surface mount reflow soldering description"*.

16.1 Introduction to soldering

Soldering is one of the most common methods through which packages are attached to Printed Circuit Boards (PCBs), to form electrical circuits. The soldered joint provides both the mechanical and the electrical connection. There is no single soldering method that is ideal for all IC packages. Wave soldering is often preferred when through-hole and Surface Mount Devices (SMDs) are mixed on one printed wiring board; however, it is not suitable for fine pitch SMDs. Reflow soldering is ideal for the small pitches and high densities that come with increased miniaturization.

16.2 Wave and reflow soldering

Wave soldering is a joining technology in which the joints are made by solder coming from a standing wave of liquid solder. The wave soldering process is suitable for the following:

- Through-hole components
- Leaded or leadless SMDs, which are glued to the surface of the printed circuit board

Not all SMDs can be wave soldered. Packages with solder balls, and some leadless packages which have solder lands underneath the body, cannot be wave soldered. Also, leaded SMDs with leads having a pitch smaller than ~0.6 mm cannot be wave soldered, due to an increased probability of bridging.

The reflow soldering process involves applying solder paste to a board, followed by component placement and exposure to a temperature profile. Leaded packages, packages with solder balls, and leadless packages are all reflow solderable.

Key characteristics in both wave and reflow soldering are:

- Board specifications, including the board finish, solder masks and vias
- Package footprints, including solder thieves and orientation
- The moisture sensitivity level of the packages
- Package placement
- Inspection and repair
- Lead-free soldering versus SnPb soldering

16.3 Wave soldering

Key characteristics in wave soldering are:

- Process issues, such as application of adhesive and flux, clinching of leads, board transport, the solder wave parameters, and the time during which components are exposed to the wave
- Solder bath specifications, including temperature and impurities

16.4 Reflow soldering

Key characteristics in reflow soldering are:

- Lead-free versus SnPb soldering; note that a lead-free reflow process usually leads to higher minimum peak temperatures (see [Figure 23](#)) than a SnPb process, thus reducing the process window
- Solder paste printing issues including smearing, release, and adjusting the process window for a mix of large and small components on one board
- Reflow temperature profile; this profile includes preheat, reflow (in which the board is heated to the peak temperature) and cooling down. It is imperative that the peak temperature is high enough for the solder to make reliable solder joints (a solder paste characteristic). In addition, the peak temperature must be low enough that the packages and/or boards are not damaged. The peak temperature of the package depends on package thickness and volume and is classified in accordance with [Table 10](#) and [11](#)

Table 10. SnPb eutectic process (from J-STD-020D)

Package thickness (mm)	Package reflow temperature (°C)	
	Volume (mm ³)	
	< 350	≥ 350
< 2.5	235	220
≥ 2.5	220	220

Table 11. Lead-free process (from J-STD-020D)

Package thickness (mm)	Package reflow temperature (°C)		
	Volume (mm ³)		
	< 350	350 to 2000	> 2000
< 1.6	260	260	260
1.6 to 2.5	260	250	245
> 2.5	250	245	245

Moisture sensitivity precautions, as indicated on the packing, must be respected at all times.

Studies have shown that small packages reach higher temperatures during reflow soldering, see [Figure 23](#).

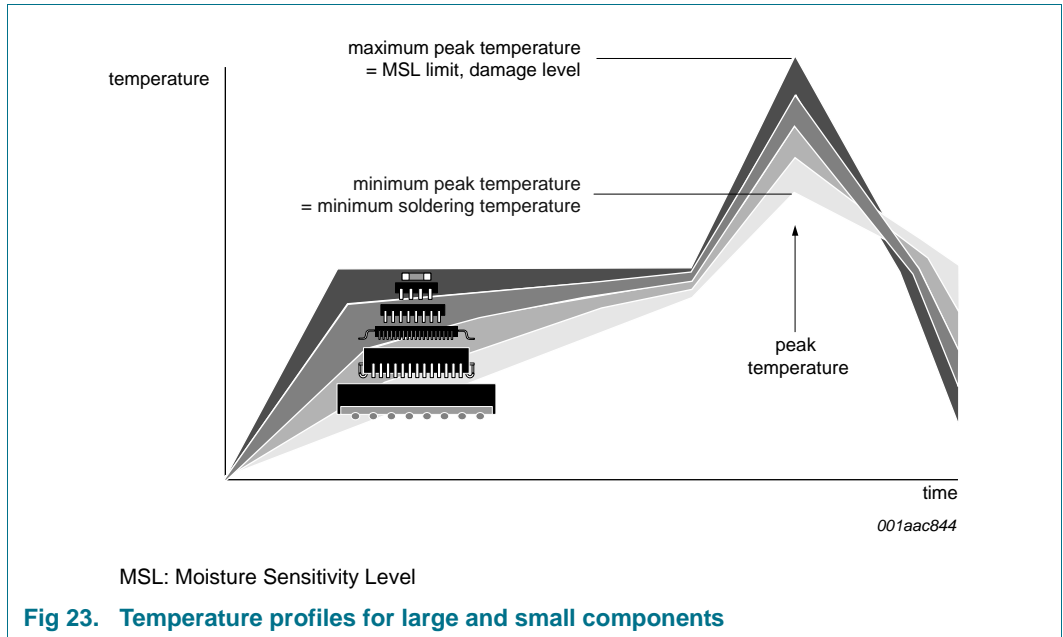

For further information on temperature profiles, refer to Application Note AN10365 “Surface mount reflow soldering description”.

17. Soldering: PCB footprints

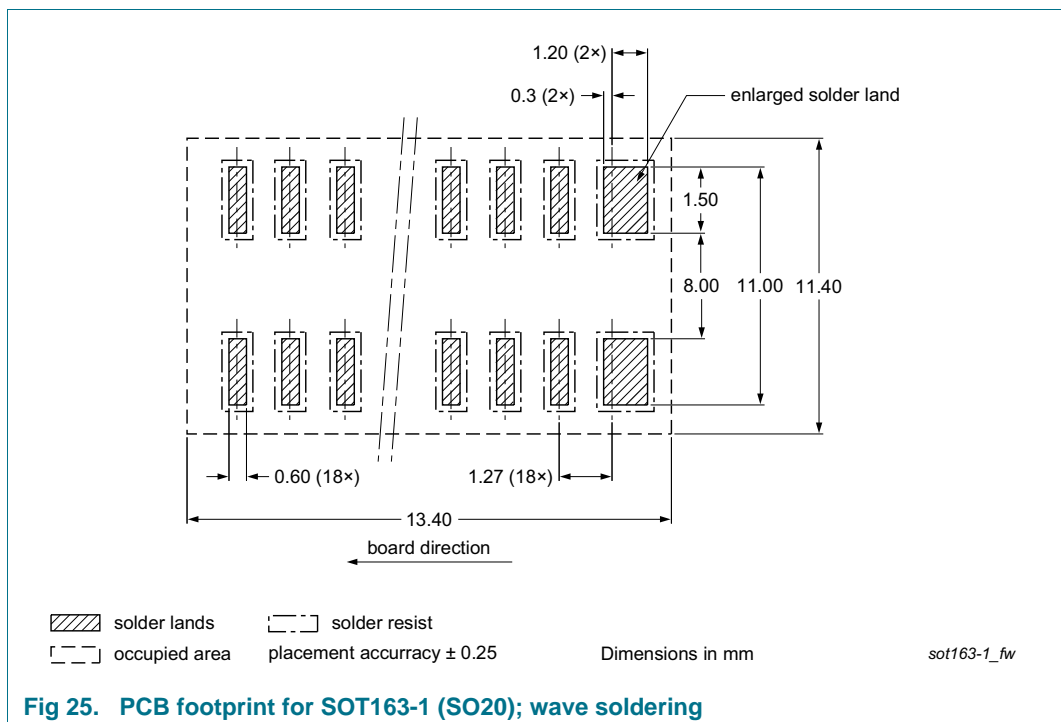
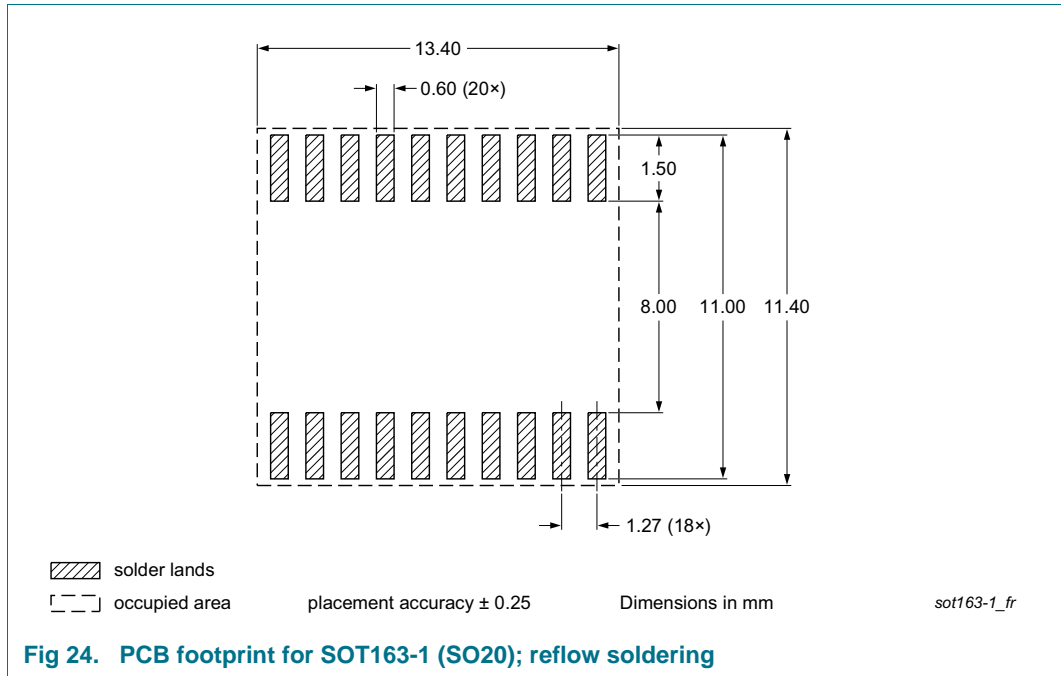

Footprint information for reflow soldering of SSOP20 package

SOT266-1

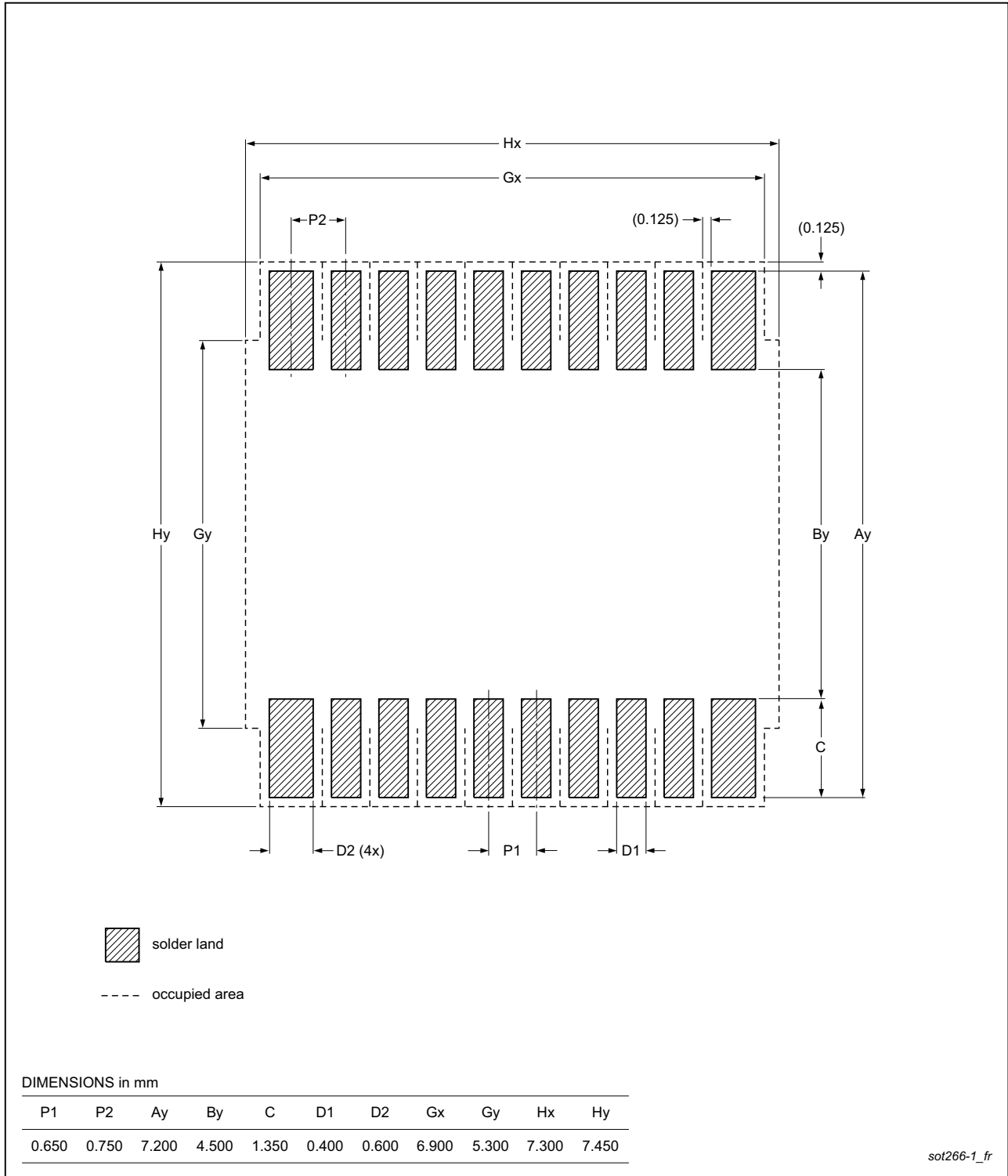

Fig 26. PCB footprint for SOT266-1 (SSOP20); reflow soldering

18. Abbreviations

Table 12. Abbreviations

Acronym	Description
AM	Amplitude Modulation
AMPS	Advanced Mobile Phone System
ASK	Amplitude Shift Keying
CDM	Charged-Device Model
ESD	ElectroStatic Discharge
ESR	Equivalent Series Resistance
FM	Frequency Modulation
FSK	Frequency Shift Keying
HBM	Human Body Model
IF	Intermediate Frequency
LC	inductor/capacitor filter
LO	Local Oscillator
PCB	Printed-Circuit Board
RF	Radio Frequency
RMS	Root Mean Squared
RSSI	Received Signal Strength Indicator
SINAD	Signal-to-Noise And Distortion ratio
TACS	Total Access Communication System
VHF	Very High Frequency

19. Revision history

Table 13. Revision history

Document ID	Release date	Data sheet status	Change notice	Supersedes
SA606 v.6	20131108	Product data sheet	-	SA606 v.5
Modifications:	<ul style="list-style-type: none"> • Table 1 “Ordering information”: <ul style="list-style-type: none"> – added Type number SA606DK/02 – added Type number SA606DK/03 • Added Section 4.1 “Ordering options” • Figure 3 “Pin configuration for SSOP20”: added Type numbers SA606DK/02 and SA606DK/03 • Table 5 “Thermal characteristics”: appended type numbers SA606DK/02, SA606DK/03 to Conditions • Table 7 “Dynamic characteristics”: $V_{o(RSSI)}$ for Condition RF level = -68 dB: <ul style="list-style-type: none"> – Added “SA606D/01, SA606DK/01” to (existing) Condition – Added Condition “SA606DK/02; RF level = -68 dBm” – Added Condition “SA606DK/03; RF level = -68 dBm” • Figure 13 “RSSI output voltage versus IF level (SA606D/01; SA606DK/01)”: appended “(SA606D/01; SA606DK/01)” to figure title • Figure 14 “RSSI output voltage versus RF level (SA606D/01; SA606DK/01)”: appended “(SA606D/01; SA606DK/01)” to figure title • Added Section 17 “Soldering: PCB footprints” 			
SA606 v.5	20120724	Product data sheet	-	SA606 v.4
SA606 v.4	20110412	Product data sheet	-	SA606 v.3
SA606 v.3	20110317	Product data sheet	-	SA606 v.2
SA606 v.2	19971107	Product specification	ECN 853-1576 18665 dated 1997 Nov 07	SA606 v.1
SA606 v.1	19931026	Product specification	-	-

20. Legal information

20.1 Data sheet status

Document status ^{[1][2]}	Product status ^[3]	Definition
Objective [short] data sheet	Development	This document contains data from the objective specification for product development.
Preliminary [short] data sheet	Qualification	This document contains data from the preliminary specification.
Product [short] data sheet	Production	This document contains the product specification.

[1] Please consult the most recently issued document before initiating or completing a design.

[2] The term 'short data sheet' is explained in section "Definitions".

[3] The product status of device(s) described in this document may have changed since this document was published and may differ in case of multiple devices. The latest product status information is available on the Internet at URL <http://www.nxp.com>.

20.2 Definitions

Draft — The document is a draft version only. The content is still under internal review and subject to formal approval, which may result in modifications or additions. NXP Semiconductors does not give any representations or warranties as to the accuracy or completeness of information included herein and shall have no liability for the consequences of use of such information.

Short data sheet — A short data sheet is an extract from a full data sheet with the same product type number(s) and title. A short data sheet is intended for quick reference only and should not be relied upon to contain detailed and full information. For detailed and full information see the relevant full data sheet, which is available on request via the local NXP Semiconductors sales office. In case of any inconsistency or conflict with the short data sheet, the full data sheet shall prevail.

Product specification — The information and data provided in a Product data sheet shall define the specification of the product as agreed between NXP Semiconductors and its customer, unless NXP Semiconductors and customer have explicitly agreed otherwise in writing. In no event however, shall an agreement be valid in which the NXP Semiconductors product is deemed to offer functions and qualities beyond those described in the Product data sheet.

20.3 Disclaimers

Limited warranty and liability — Information in this document is believed to be accurate and reliable. However, NXP Semiconductors does not give any representations or warranties, expressed or implied, as to the accuracy or completeness of such information and shall have no liability for the consequences of use of such information. NXP Semiconductors takes no responsibility for the content in this document if provided by an information source outside of NXP Semiconductors.

In no event shall NXP Semiconductors be liable for any indirect, incidental, punitive, special or consequential damages (including - without limitation - lost profits, lost savings, business interruption, costs related to the removal or replacement of any products or rework charges) whether or not such damages are based on tort (including negligence), warranty, breach of contract or any other legal theory.

Notwithstanding any damages that customer might incur for any reason whatsoever, NXP Semiconductors' aggregate and cumulative liability towards customer for the products described herein shall be limited in accordance with the *Terms and conditions of commercial sale* of NXP Semiconductors.

Right to make changes — NXP Semiconductors reserves the right to make changes to information published in this document, including without limitation specifications and product descriptions, at any time and without notice. This document supersedes and replaces all information supplied prior to the publication hereof.

Suitability for use — NXP Semiconductors products are not designed, authorized or warranted to be suitable for use in life support, life-critical or safety-critical systems or equipment, nor in applications where failure or malfunction of an NXP Semiconductors product can reasonably be expected to result in personal injury, death or severe property or environmental damage. NXP Semiconductors and its suppliers accept no liability for inclusion and/or use of NXP Semiconductors products in such equipment or applications and therefore such inclusion and/or use is at the customer's own risk.

Applications — Applications that are described herein for any of these products are for illustrative purposes only. NXP Semiconductors makes no representation or warranty that such applications will be suitable for the specified use without further testing or modification.

Customers are responsible for the design and operation of their applications and products using NXP Semiconductors products, and NXP Semiconductors accepts no liability for any assistance with applications or customer product design. It is customer's sole responsibility to determine whether the NXP Semiconductors product is suitable and fit for the customer's applications and products planned, as well as for the planned application and use of customer's third party customer(s). Customers should provide appropriate design and operating safeguards to minimize the risks associated with their applications and products.

NXP Semiconductors does not accept any liability related to any default, damage, costs or problem which is based on any weakness or default in the customer's applications or products, or the application or use by customer's third party customer(s). Customer is responsible for doing all necessary testing for the customer's applications and products using NXP Semiconductors products in order to avoid a default of the applications and the products or of the application or use by customer's third party customer(s). NXP does not accept any liability in this respect.

Limiting values — Stress above one or more limiting values (as defined in the Absolute Maximum Ratings System of IEC 60134) will cause permanent damage to the device. Limiting values are stress ratings only and (proper) operation of the device at these or any other conditions above those given in the Recommended operating conditions section (if present) or the Characteristics sections of this document is not warranted. Constant or repeated exposure to limiting values will permanently and irreversibly affect the quality and reliability of the device.

Terms and conditions of commercial sale — NXP Semiconductors products are sold subject to the general terms and conditions of commercial sale, as published at <http://www.nxp.com/profile/terms>, unless otherwise agreed in a valid written individual agreement. In case an individual agreement is concluded only the terms and conditions of the respective agreement shall apply. NXP Semiconductors hereby expressly objects to applying the customer's general terms and conditions with regard to the purchase of NXP Semiconductors products by customer.

No offer to sell or license — Nothing in this document may be interpreted or construed as an offer to sell products that is open for acceptance or the grant, conveyance or implication of any license under any copyrights, patents or other industrial or intellectual property rights.

Export control — This document as well as the item(s) described herein may be subject to export control regulations. Export might require a prior authorization from competent authorities.

Non-automotive qualified products — Unless this data sheet expressly states that this specific NXP Semiconductors product is automotive qualified, the product is not suitable for automotive use. It is neither qualified nor tested in accordance with automotive testing or application requirements. NXP Semiconductors accepts no liability for inclusion and/or use of non-automotive qualified products in automotive equipment or applications.

In the event that customer uses the product for design-in and use in automotive applications to automotive specifications and standards, customer (a) shall use the product without NXP Semiconductors' warranty of the product for such automotive applications, use and specifications, and (b) whenever customer uses the product for automotive applications beyond

NXP Semiconductors' specifications such use shall be solely at customer's own risk, and (c) customer fully indemnifies NXP Semiconductors for any liability, damages or failed product claims resulting from customer design and use of the product for automotive applications beyond NXP Semiconductors' standard warranty and NXP Semiconductors' product specifications.

Translations — A non-English (translated) version of a document is for reference only. The English version shall prevail in case of any discrepancy between the translated and English versions.

20.4 Trademarks

Notice: All referenced brands, product names, service names and trademarks are the property of their respective owners.

21. Contact information

For more information, please visit: <http://www.nxp.com>

For sales office addresses, please send an email to: salesaddresses@nxp.com

22. Contents

1	General description	1
2	Features and benefits	1
3	Applications	1
4	Ordering information	2
4.1	Ordering options	2
5	Block diagram	3
6	Pinning information	4
6.1	Pinning	4
6.2	Pin description	5
7	Functional description	6
8	Limiting values	7
9	Thermal characteristics	7
10	Static characteristics	7
11	Dynamic characteristics	8
12	Performance curves	9
13	Application information	15
14	Test information	19
15	Package outline	22
16	Soldering of SMD packages	24
16.1	Introduction to soldering	24
16.2	Wave and reflow soldering	24
16.3	Wave soldering	24
16.4	Reflow soldering	25
17	Soldering: PCB footprints	27
18	Abbreviations	29
19	Revision history	30
20	Legal information	31
20.1	Data sheet status	31
20.2	Definitions	31
20.3	Disclaimers	31
20.4	Trademarks	32
21	Contact information	32
22	Contents	33

Please be aware that important notices concerning this document and the product(s) described herein, have been included in section 'Legal information'.

© NXP B.V. 2013.

All rights reserved.

For more information, please visit: <http://www.nxp.com>

For sales office addresses, please send an email to: salesaddresses@nxp.com

Date of release: 8 November 2013

Document identifier: SA606







Looking for pricing, stock, or lifecycle information?

Click below to explore more details on WIN SOURCE:

 [View SA606D/01,112 on WIN SOURCE](#)

 [NXP / Nexperia Information](#)

Optimize Your Supply Chain with WIN SOURCE Solutions

-  Global Sourcing Solution
-  Obsolete Management
-  Cost Control Management
-  Shortage Management
-  Alternative Solution
-  Excess Inventory Management