



**THE DATASHEET OF
SI4765-A20-AMR**



Description

The Si476x radio receiver family employs 100% RF CMOS technology to bring outstanding receiver performance to the automotive infotainment industry, which demands high performance and quality.

The Si476x receiver family supports worldwide FM and AM radio reception. Additional variants support weather band, shortwave, longwave frequencies, and dual antenna FM phase diversity reception.

The Si476x incorporates a digital processor for the European Radio Data System (RDS) and the North American Radio Broadcast Data System (RBDS) including all required symbol decoding, block synchronization, error detection, and error correction functions. All odd-numbered variants in the family support AM/FM HD Radio channel reception with digital (I²S) baseband I/Q outputs for interface to a HD Radio demodulator/decoder.

The family leverages Silicon Laboratories' patented digital architecture, delivering superior RF performance and interference rejection. The proven digital techniques provide excellent sensitivity in weak signal environments, and superb selectivity and inter-modulation immunity in strong signal environments.

The solution offers dynamic AM/FM channel bandwidth control, auto-calibrated digital tuning, and proven AM/FM seek functionality based on multiple signal quality and band parameters. The family offers highly flexible and advanced audio processing including AM/FM noise blanking, programmable soft mute, FM multi-path mitigation, FM stereo-mono blend, and FM hi-cut. In addition, the Si476x provides an integrated clock oscillator or accepts a reference clock and an I²C-compatible, 2-wire control interface. The Si476x receiver system specifies a minimal bill of materials, resulting in a very small board space requirement and making the solution ideal for any automotive application from single tuner radios to multiple tuner radios addressing companion TMC/AF reception/scanning.

Features

- Worldwide FM band support (64–108 MHz)
- AM/FM HDR support
- Worldwide AM band support (520–1710 kHz)
- Advanced RDS/RBDS demodulator/decoder
- Digital FM MPX decoder
- Integrated FM active splitter
 - Addresses companion AF/RDS data receiver
- Advanced AM/FM noise blankers
- Dynamic AM/FM channel bandwidth control
- Advanced FM hi-cut control
- Programmable FM stereo-mono blend
- Programmable AM/FM soft mute
- Full suite of signal metrics: RSSI, SNR, multi-path interference, frequency offset, adjacent channel strength, USN
- Analog and digital (I²S) audio outputs
- Digital (I²S) baseband AM/FM I/Q
- Analog FM MPX output
- Low-IF architecture
 - Eliminates expensive 10.7 MHz IF ceramic filters
- On-chip AM/FM AGC with integrated resistor and varactor banks
 - Eliminates external pin diode attenuators and varactors
- 1.5 to 5 V power supplies
- QFN 40, 6 x 6 x 0.85 mm
 - Pb-free/RoHS compliant
- AEC-Q100 qualified

Applications

- OEM automotive infotainment systems
- Aftermarket car radio systems
- OEM automotive PND docking system



Selected Electrical Specifications

Parameter	Test Conditions	Min	Typ	Max	Units
Ambient temperature		-40	25	85	°C
Analog supply voltage 5 V (VA)		4.5	5	5.5	V
Digital supply voltage 3.3 V (VD)		2.7	3.3	3.6	V
Interface supply voltage (VIO1)		1.7	3.3	3.6	V
Interface supply voltage (VIO2)		1.2	3.3	3.6	V
Analog supply current		—	130	—	mA
Digital supply current		—	60	—	mA
Interface supply current (VIO1)		—	90	—	μA
Interface supply current (VIO2)		—	20	—	μA
FM					
Input frequency		64		108	MHz
Tune time		—	0.9	—	ms
AF scan time		—	7.5	—	ms
Seek time/channel		—	20	—	ms
Max frequency deviation		—	150	—	kHz
AM					
Input frequency		510		1710	kHz
Seek time/channel		—	55	—	ms

Pin Assignment

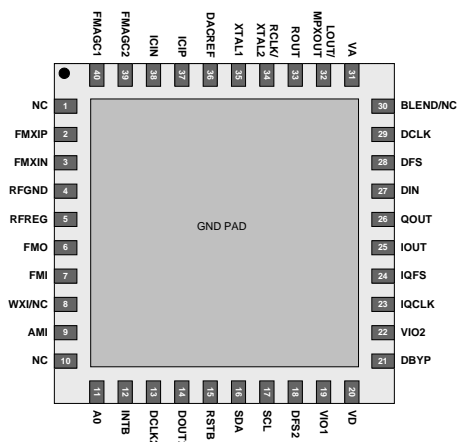

Package Information



Symbol	Millimeters		
	Min	Nom	Max
A	0.80	0.85	0.90
A1	0.00	0.02	0.05
b	0.18	0.25	0.30
D	6.00 BSC		
D2	3.95	4.10	4.25
e	0.50 BSC		

Symbol	Millimeters		
	Min	Nom	Max
E	6.00 BSC		
E2	3.95	4.10	4.25
L	0.30	0.40	0.50
L1	0.03	0.05	0.08
aaa	0.10		
bbb	0.10		



Smart.
Connected.
Energy-Friendly



Products
www.silabs.com/products



Quality
www.silabs.com/quality



Support and Community
community.silabs.com

Disclaimer

Silicon Laboratories intends to provide customers with the latest, accurate, and in-depth documentation of all peripherals and modules available for system and software implementers using or intending to use the Silicon Laboratories products. Characterization data, available modules and peripherals, memory sizes and memory addresses refer to each specific device, and "Typical" parameters provided can and do vary in different applications. Application examples described herein are for illustrative purposes only. Silicon Laboratories reserves the right to make changes without further notice and limitation to product information, specifications, and descriptions herein, and does not give warranties as to the accuracy or completeness of the included information. Silicon Laboratories shall have no liability for the consequences of use of the information supplied herein. This document does not imply or express copyright licenses granted hereunder to design or fabricate any integrated circuits. The products must not be used within any Life Support System without the specific written consent of Silicon Laboratories. A "Life Support System" is any product or system intended to support or sustain life and/or health, which, if it fails, can be reasonably expected to result in significant personal injury or death. Silicon Laboratories products are generally not intended for military applications. Silicon Laboratories products shall under no circumstances be used in weapons of mass destruction including (but not limited to) nuclear, biological or chemical weapons, or missiles capable of delivering such weapons.

Trademark Information

Silicon Laboratories Inc., Silicon Laboratories, Silicon Labs, SiLabs and the Silicon Labs logo, CMEMS®, EFM, EFM32, EFR, Energy Micro, Energy Micro logo and combinations thereof, "the world's most energy friendly microcontrollers", Ember®, EZLink®, EZMac®, EZRadio®, EZRadioPRO®, DSPLL®, ISOmodem®, Precision32®, ProSLIC®, SiPHY®, USBXpress® and others are trademarks or registered trademarks of Silicon Laboratories Inc. ARM, CORTEX, Cortex-M3 and THUMB are trademarks or registered trademarks of ARM Holdings. Keil is a registered trademark of ARM Limited. All other products or brand names mentioned herein are trademarks of their respective holders.





Silicon Laboratories Inc.
400 West Cesar Chavez
Austin, TX 78701
USA

<http://www.silabs.com>

Looking for pricing, stock, or lifecycle information?

Click below to explore more details on WIN SOURCE:

-  [View S14765-A20-AMR on WIN SOURCE](#)
-  [Skyworks Solutions Inc. Information](#)

Optimize Your Supply Chain with WIN SOURCE Solutions

-  Global Sourcing Solution
-  Obsolete Management
-  Cost Control Management
-  Shortage Management
-  Alternative Solution
-  Excess Inventory Management