



**THE DATASHEET OF
SI4757-A10-AM**



Description

The Si475x radio receiver family employs RF CMOS technology to bring outstanding radio receiver performance and automotive quality to the automotive infotainment industry. The Si475x family supports worldwide FM, AM, shortwave, longwave, and weatherband radio reception. The Si475x receiver system specifies a minimal bill of materials, resulting in a very small board space requirement, making the solution ideal for any automotive application from single tuner radios to multiple tuner radios addressing companion TMC/AF reception/scanning.

The monolithic IC incorporates a digital signal processor and microcontroller, leveraging Skyworks patented and proven low-IF architecture, delivering superior RF performance and interference rejection, as well as excellent sensitivity in weak signal environments and superb selectivity and inter-modulation immunity in strong signal environments. The device performs signal conditioning with dynamic AM/FM channel bandwidth control, a comprehensive set of weak signal processing engines, auto-calibrated digital tuning, and proven AM/FM seek functionality based on multiple signal quality and band parameters. The device offers world-class performance for complete Radio Data Service (RDS) decoding, synchronization, error detection and correction. The device is also completely configurable, allowing raw RDS data if so desired.

The part provides an integrated clock oscillator or accepts a reference clock and an I²C-compatible 2-wire control interface.

Features

- Worldwide FM band support (64–108 MHz)
- Worldwide AM band support (520–1710 kHz)
- Advanced RDS/RBDS demodulator/decoder
- Digital FM MPX decoder
- Integrated FM loop-through
 - Addresses companion AF/RDS data receiver
- Advanced AM/FM noise blankers
- Dynamic AM/FM channel bandwidth control
- Advanced FM hi-cut control
- Programmable FM stereo-mono blend
- Programmable AM/FM soft mute
- Full suite of signal metrics: RSSI, SNR, multi-path interference, frequency offset, adjacent channel strength
- Analog audio outputs
- Analog FM MPX output
- Low-IF architecture
 - Eliminates expensive 10.7 MHz IF ceramic filters
- On-chip AM/FM AGC with integrated resistor and varactor banks
 - Eliminates external PIN diode attenuators
- 1.5 to 5 V power supplies
- QFN 32, 5 x 5 x 0.85 mm
 - Pb-free/RoHS compliant
- AEC-Q100 qualified

Applications

- OEM Car Radio Systems
- Aftermarket Car Radio Systems
- OEM Car PND Docking System

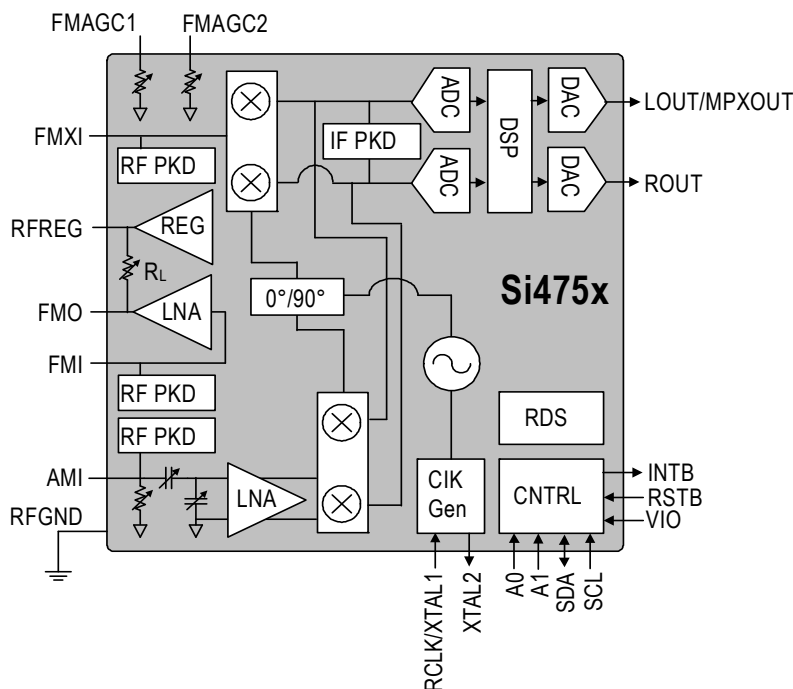

Selected Electrical Specifications

Parameter	Test Conditions	Min	Typ	Max	Units
Ambient temperature		-40	25	85	°C
Analog supply voltage 5 V (VA)		4.5	5	5.5	V
Digital supply voltage 3.3 V (VD)		2.7		3.6	V
Interface supply voltage (VIO)		1.7		3.6	V
Analog supply current			150		mA
Digital supply current			50		mA
Interface supply current (VIO)			5		mA
FM					
Input frequency		64		108	MHz
Tune time			0.9		msec
AF scan time			8		msec
Seek time/channel			35		msec
Max frequency deviation			150		kHz
Maximum RF input voltage			130		dBuV
AM					

Package Outline

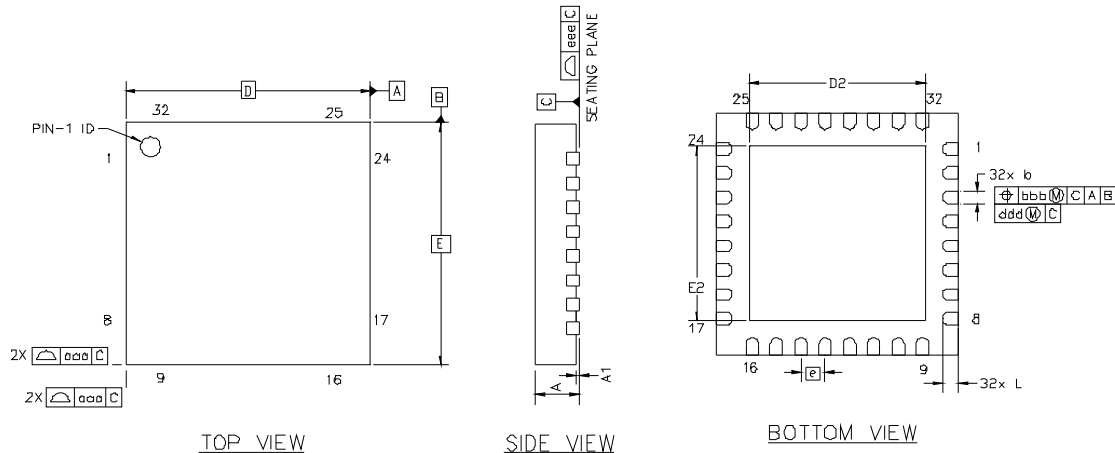

Dimensions	Min	Nom	Max
AT	0.80	0.85	0.90
A1	0.00	0.02	0.05
b	0.18	0.25	0.30
D	5.00 BSC.		
D2	3.45	3.60	3.75
e	0.50 BSC.		
E	5.00 BSC.		

Dimensions	Min	Nom	Max
E2	3.50	3.60	3.70
L	0.35	0.40	0.45
aaa	—	—	0.15
bbb	—	—	0.10
ddd	—	—	0.05
eee	—	—	0.08

Notes:

- All dimensions shown are in millimeters (mm) unless otherwise noted.
- Dimensioning and Tolerancing per ANSI Y14.5M-1994.
- This drawing conforms to the JEDEC Solid State Outline MO-220, variation VHHD except for custom features D2, E2, L, and L1 which are toleranced per supplier designation.
- Recommended card reflow profile is per the JEDEC/IPC J-STD-020 specification for Small Body Components.



SKYWORKS®

**Connecting Everyone
and Everything,
All the Time**



Portfolio

www.skyworksinc.com

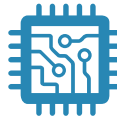

Quality

www.skyworksinc.com/quality



Support & Resources

www.skyworksinc.com/support

Copyright © 2021 Skyworks Solutions, Inc. All Rights Reserved.

Information in this document is provided in connection with Skyworks Solutions, Inc. ("Skyworks") products or services. These materials, including the information contained herein, are provided by Skyworks as a service to its customers and may be used for informational purposes only by the customer. Skyworks assumes no responsibility for errors or omissions in these materials or the information contained herein. Skyworks may change its documentation, products, services, specifications or product descriptions at any time, without notice. Skyworks makes no commitment to update the materials or information and shall have no responsibility whatsoever for conflicts, incompatibilities, or other difficulties arising from any future changes.

No license, whether express, implied, by estoppel or otherwise, is granted to any intellectual property rights by this document. Skyworks assumes no liability for any materials, products or information provided hereunder, including the sale, distribution, reproduction or use of Skyworks products, information or materials, except as may be provided in Skyworks' Terms and Conditions of Sale.

THE MATERIALS, PRODUCTS AND INFORMATION ARE PROVIDED "AS IS" WITHOUT WARRANTY OF ANY KIND, WHETHER EXPRESS, IMPLIED, STATUTORY, OR OTHERWISE, INCLUDING FITNESS FOR A PARTICULAR PURPOSE OR USE, MERCHANTABILITY, PERFORMANCE, QUALITY OR NON-INFRINGEMENT OF ANY INTELLECTUAL PROPERTY RIGHT; ALL SUCH WARRANTIES ARE HEREBY EXPRESSLY DISCLAIMED. SKYWORKS DOES NOT WARRANT THE ACCURACY OR COMPLETENESS OF THE INFORMATION, TEXT, GRAPHICS OR OTHER ITEMS CONTAINED WITHIN THESE MATERIALS. SKYWORKS SHALL NOT BE LIABLE FOR ANY DAMAGES, INCLUDING BUT NOT LIMITED TO ANY SPECIAL, INDIRECT, INCIDENTAL, STATUTORY, OR CONSEQUENTIAL DAMAGES, INCLUDING WITHOUT LIMITATION, LOST REVENUES OR LOST PROFITS THAT MAY RESULT FROM THE USE OF THE MATERIALS OR INFORMATION, WHETHER OR NOT THE RECIPIENT OF MATERIALS HAS BEEN ADVISED OF THE POSSIBILITY OF SUCH DAMAGE.

Skyworks products are not intended for use in medical, lifesaving or life-sustaining applications, or other equipment in which the failure of the Skyworks products could lead to personal injury, death, physical or environmental damage. Skyworks customers using or selling Skyworks products for use in such applications do so at their own risk and agree to fully indemnify Skyworks for any damages resulting from such improper use or sale.

Customers are responsible for their products and applications using Skyworks products, which may deviate from published specifications as a result of design defects, errors, or operation of products outside of published parameters or design specifications. Customers should include design and operating safeguards to minimize these and other risks. Skyworks assumes no liability for applications assistance, customer product design, or damage to any equipment resulting from the use of Skyworks products outside of Skyworks' published specifications or parameters.

Skyworks, the Skyworks symbol, Sky5®, SkyOne®, SkyBlue™, Skyworks Green™, Clockbuilder®, DSPLL®, ISOModem®, ProSLIC®, and SiPHY® are trademarks or registered trademarks of Skyworks Solutions, Inc. or its subsidiaries in the United States and other countries. Third-party brands and names are for identification purposes only and are the property of their respective owners. Additional information, including relevant terms and conditions, posted at www.skyworksinc.com, are incorporated by reference.

Skyworks Solutions, Inc. | Nasdaq: SWKS | sales@skyworksinc.com | www.skyworksinc.com

USA: 781-376-3000 | Asia: 886-2-2735 0399 | Europe: 33 (0)1 43548540 | [in](https://www.linkedin.com/company/skyworks) [f](https://www.facebook.com/skyworks) [t](https://twitter.com/skyworks) [y](https://www.youtube.com/skyworks)

Looking for pricing, stock, or lifecycle information?

Click below to explore more details on WIN SOURCE:

- ⊖ [View SI4757-A10-AM on WIN SOURCE](#)
- ⊖ [Skyworks Solutions Inc. Information](#)

Optimize Your Supply Chain with WIN SOURCE Solutions

- ✓ Global Sourcing Solution
- ✓ Obsolete Management
- ✓ Cost Control Management
- ✓ Shortage Management
- ✓ Alternative Solution
- ✓ Excess Inventory Management