



**THE DATASHEET OF
SARA-G450-00C-00**





SARA-G450

Quad-band GSM/GPRS module

Data sheet



Abstract

Technical data sheet describing the SARA-G450 GSM/GPRS cellular modules. These modules are complete and cost efficient solutions offering quad-band GSM/GPRS voice and/or data transmission technology in a compact form factor.

Document information

Title	SARA-G450	
Subtitle	Quad-band GSM/GPRS module	
Document type	Data sheet	
Document number	UBX-18006165	
Revision and date	R11	08-Mar-2021
Disclosure restriction	C1-Public	

Product status	Corresponding content status	
Functional sample	Draft	For functional testing. Revised and supplementary data will be published later.
In development / Prototype	Objective specification	Target values. Revised and supplementary data will be published later.
Engineering sample	Advance information	Data based on early testing. Revised and supplementary data will be published later.
Initial production	Early Production information	Data from product verification. Revised and supplementary data may be published later.
Mass production / End of life	Production information	Document contains the final product specification.

This document applies to the following products:

Product name	Type number	Modem version	Application version	PCN reference	Product status
SARA-G450	SARA-G450-00C-00	09.02	A02.01	UBX-18067098	Obsolete
	SARA-G450-00C-01	09.02	A03.17	UBX-20033037	Mass production
	SARA-G450-01C-00	09.02	A04.23	UBX-20033037	End of life
	SARA-G450-01C-01	09.02	A05.01	UBX-21006193	Mass production

u-blox or third parties may hold intellectual property rights in the products, names, logos and designs included in this document. Copying, reproduction, modification or disclosure to third parties of this document or any part thereof is only permitted with the express written permission of u-blox.

The information contained herein is provided "as is" and u-blox assumes no liability for its use. No warranty, either express or implied, is given, including but not limited to, with respect to the accuracy, correctness, reliability and fitness for a particular purpose of the information. This document may be revised by u-blox at any time without notice. For the most recent documents, visit www.u-blox.com.

Copyright © u-blox AG.

Contents

Document information	2
Contents	3
1 Functional description	5
1.1 Overview.....	5
1.2 Product features.....	5
1.3 Block diagram.....	6
1.4 Product description.....	6
1.5 AT command support.....	7
1.6 Supported features.....	7
2 Interfaces	10
2.1 Power management.....	10
2.1.1 Module supply input (VCC).....	10
2.1.2 RTC supply input/output (V_BCKP).....	10
2.1.3 Digital I/O interfaces supply output (V_INT).....	10
2.2 Antenna.....	11
2.2.1 Antenna RF interface (ANT).....	11
2.2.2 Antenna detection (ANT_DET).....	11
2.3 System functions.....	11
2.3.1 Module power-on (PWR_ON).....	11
2.3.2 Module power-off.....	11
2.3.3 Module reset.....	12
2.3.4 Digital I/O interfaces voltage selection (VSEL).....	12
2.4 SIM.....	12
2.4.1 (U)SIM interface.....	12
2.4.2 SIM card detection (SIM_DET).....	12
2.5 Serial interfaces.....	13
2.5.1 Asynchronous serial interface (UART).....	13
2.5.2 Secondary auxiliary asynchronous serial interface (AUX UART).....	14
2.5.3 Additional asynchronous serial interface for FW upgrade and tracing (FT UART).....	15
2.5.4 DDC (I2C compatible) interface.....	15
2.6 Audio interface.....	15
2.7 GPIO.....	16
3 Pin definition	17
3.1 Pin assignment.....	17
4 Electrical specifications	21
4.1 Absolute maximum rating.....	21
4.1.1 Maximum ESD.....	22
4.2 Operating conditions.....	22
4.2.1 Operating temperature range.....	22
4.2.2 Supply/Power pins.....	22

4.2.3	Current consumption.....	23
4.2.4	RF performance	24
4.2.5	ANT_DET pin.....	24
4.2.6	PWR_ON pin.....	24
4.2.7	PWR_OFF pin.....	24
4.2.8	SIM pins	25
4.2.9	Generic Digital Interfaces pins	25
4.2.10	DDC (I2C) pins.....	26
4.2.11	Audio pins.....	26
5	Mechanical specifications	28
6	Qualification and approvals.....	30
6.1	Reliability tests.....	30
6.2	Approvals.....	30
7	Product handling.....	31
7.1	Packaging	31
7.1.1	Reels	31
7.1.2	Tapes.....	32
7.2	Moisture sensitivity levels.....	33
7.3	Reflow soldering	33
7.4	ESD precautions.....	33
8	Default settings	34
9	Labeling and ordering information	35
9.1	Product labeling.....	35
9.2	Explanation of codes	35
9.3	Ordering information.....	36
Appendix	37
A	Glossary	37
Related documentation	39
Revision history	39
Contact.....	40

1 Functional description

1.1 Overview

SARA-G450 modules are versatile 2.5G GSM/GPRS cellular modules in the miniature SARA 96-pin LGA (Land Grid Array) form factor (26.0 x 16.0 mm).

Featuring low power consumption, the SARA-G450 modules combine baseband, RF transceiver, power management unit, and power amplifier in a single solution allowing an easy integration into compact designs and a seamless drop-in migration from other u-blox cellular module families supporting 2G, 3G, LTE and LPWA (Cat M1 and Cat NB1) radio access technologies.

SARA-G450 modules provide a fully qualified and certified solution, reducing cost and enabling short time to market. These modules are ideally suited for M2M applications such as: Automatic Meter Reading (AMR), Remote Monitoring Automation and Control (RMAC), surveillance and security, road pricing, asset tracking, fleet management, anti-theft systems and Point of Sales (PoS) terminals.

SARA-G450 modules are full-feature GSM/GPRS quad band cellular modules with a comprehensive feature set including an extensive set of internet protocols. The modules are also designed to provide fully integrated access to u-blox GNSS positioning chips and modules, with embedded A-GPS (AssistNow Online and AssistNow Offline) functionality. Any host processor connected to the cellular module through a single serial port can control both the cellular module and the positioning chip/module.

The SARA-G450 modules' compact form factor and LGA pads allow fully automated assembly with standard pick & place and reflow soldering equipment for cost-efficient, high-volume production.

1.2 Product features

Model	Data rate	Bands	Interfaces	Audio	Features	Grade
	GPRS multi-slot class 12	GSM/GPRS 4-band	UART SPI USB 2.0 DDC (I2C) GPIO	Analog audio Digital audio	Network indication Antenna supervisor Jamming detection Embedded TCP/UDP Embedded HTTP, FTP Embedded SSL / TLS GNSS via modem AssistNow software CellLocate® FW update via serial FOTA Dual stack IPv4 / IPv6	Standard Professional Automotive
SARA-G450	•	•	• □ •	□	• • □ • • • □ □ □ • •	•

• = supported by all FW versions

□ = supported by product version "01" onwards

Table 1: SARA-G450 modules' main features summary

1.3 Block diagram

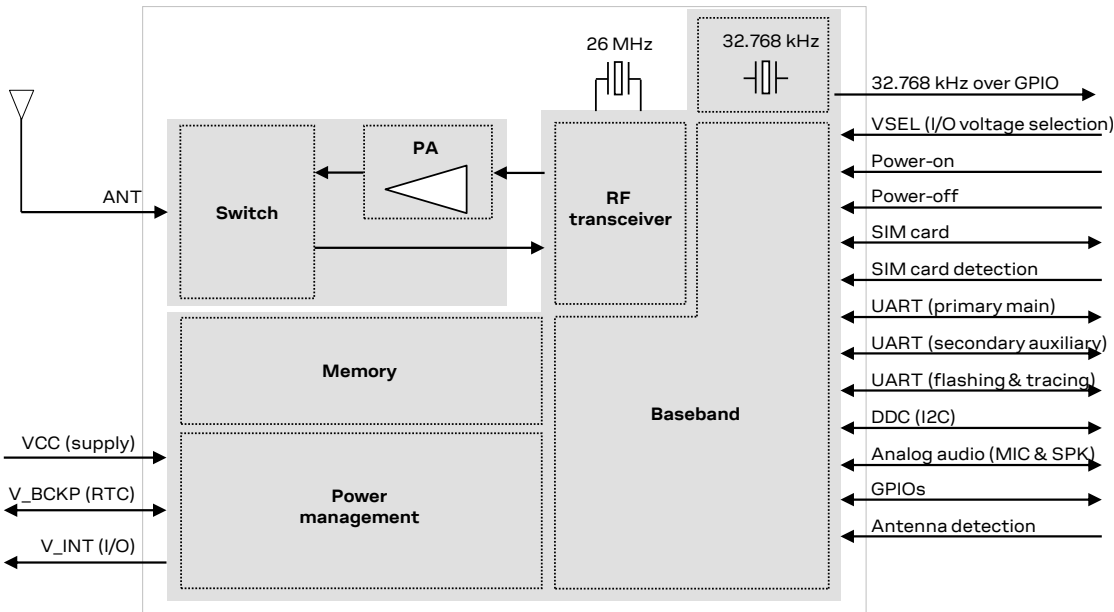

Figure 1: SARA-G450 modules' block diagram

SARA-G450-00C modules, i.e. the “00” product version of the SARA-G450 modules, do not support the following interfaces, which should be left unconnected and should not be driven by external devices:

- Secondary auxiliary UART interface
- DDC (I2C) interface
- Analog audio interface

1.4 Product description

Item	SARA-G450
Mobile Station Class	B ¹
GSM/GPRS Protocol Stack	3GPP Release 99
GSM/GPRS bands	GSM 850 MHz E-GSM 900 MHz DCS 1800 MHz PCS 1900 MHz
GSM/GPRS Power Class	Class 4 (33 dBm) for 850/900 bands Class 1 (30 dBm) for 1800/1900 bands
Packet Switched Data Rate	GPRS multi-slot class 12 ² Coding scheme CS1-CS4 Up to 85.6 kb/s DL ³ Up to 85.6 kb/s UL ³

Table 2: SARA-G450 modules' GSM/GPRS characteristics summary

¹ Device can be attached to GPRS and GSM services (i.e. Packet Switch and Circuit Switch mode) using one service at a time.
² GPRS multi-slot class 12 implies a maximum of 4 slots in Down-Link (reception) and 4 slots in Up-Link (transmission) with 5 slots in total. The SARA-G450 modules can be configured as GPRS multi-slot class 10 by means of AT command.
³ The maximum bit rate of the module depends on the current network settings.

The network automatically configures the channel encoding used by the module, depending on conditions and the quality of the radio link between cell phone and base station. If the channel is very noisy, the network may use the most robust coding scheme (CS-1) to ensure higher reliability. If the channel provides good conditions, the network can use the least robust but fastest coding scheme (CS-4) to obtain optimum speed.

1.5 AT command support

The module supports AT commands according to 3GPP standards TS 27.007 [6], 27.005 [7] and 27.010 [8], plus u-blox proprietary AT commands.

 For the complete list of the supported AT commands and their syntax, see the u-blox AT commands manual [2].

1.6 Supported features

Table 3 lists some of the main features supported by SARA-G450 modules.

Feature	Description
Network indication	GPIO configured to indicate the network status: registered home network, registered roaming, voice or data call enabled, no service. The network indication feature can be enabled through a custom AT command (see the u-blox AT commands manual [2], +UGPIOC AT command).
Antenna detection	The ANT_DET pin provides antenna presence detection capability, evaluating the resistance from the ANT pin to GND by means of an external antenna detection circuit implemented on the application board. The antenna detection feature can be enabled through a custom AT command (see the u-blox AT commands manual [2], +UANTR AT command).
Jamming detection ⁴	Detects “artificial” interference that obscures the operator’s carriers providing access to the GSM service and reports the start and stop of such conditions to the application processor (AP). The AP can react appropriately, e.g. by switching off the radio transceiver to reduce power consumption and monitoring the environment at constant periods. The jamming detection feature can be enabled and configured through a custom AT command (see the u-blox AT commands manual [2], +UCD AT command).
Second AT interface ⁴	AT command and data mode available on both the primary main UART interface and the secondary auxiliary UART interface. See the u-blox AT commands manual [2], +USIO AT command, for further details regarding serial interfaces configuration selection.
Embedded TCP/IP and UDP/IP	Embedded TCP/IP and UDP/IP stack including direct link mode for TCP and UDP sockets. The sockets can be configured in direct link mode to establish a transparent end-to-end communication with an already connected TCP or UDP socket via serial interface.
FTP, FTPS	File Transfer Protocol as well as Secure File Transfer Protocol (SSL encryption of FTP control channel) functionalities are supported via AT commands.
HTTP, HTTPS	Hyper-Text Transfer Protocol as well as Secure Hyper-Text Transfer Protocol (SSL encryption) functionalities are supported via AT commands. HEAD, GET, POST, DELETE and PUT operations are available. Up to 4 client contexts can be simultaneously used.
Embedded TLS 1.2	With the support of X.509 certificates, Embedded TLS 1.2 provides server and client authentication, data encryption, data signature and enables TCP/IP applications like HTTPS and FTPS to communicate over a secured and trusted connection. The feature can be configured and enabled by +USECMNG and +USECPRF AT commands.

⁴ Not supported by “00” product version



Feature	Description
IPv4/IPv6 dual-stack	Capability to move between IPv4 and dual stack network infrastructures. IPv4 and IPv6 addresses can be used.
GPS/GNSS via modem ⁴	Full access to u-blox positioning chips and modules is available through a dedicated DDC (I2C) interface. A single serial port from any host processor can control both the u-blox SARA-G450 cellular module and the u-blox positioning chip / module.
AssistNow software ⁴	Embedded AssistNow Online and AssistNow Offline clients to provide full developed to provide better GNSS performance and faster Time-to-First-Fix. The clients can be enabled / disabled with an AT command.
CellLocate ^{®4}	Enables the estimation of device position based on the parameters of the mobile network cells visible to the specific device based on the CellLocate [®] database: <ul style="list-style-type: none"> • Normal scan: parameters of the visible home network cells are only sent • Deep scan: parameters of all surrounding cells of all mobile operators are sent CellLocate [®] is implemented using a set of AT commands for CellLocate [®] service configuration and position request.
Hybrid positioning ⁵	Provides the module's current position using a u-blox positioning chip or module or the estimated position from CellLocate [®] , depending on which positioning method provides the best and fastest solution according to the user configuration. Hybrid positioning is implemented through a set of AT commands that allow the configuration and the position request.
Firmware update Over AT commands (FOAT)	Firmware module upgrade over the UART interface, using AT command.
DTMF decoder ⁵	During a voice call, the Dual-Tone Multi-Frequency detector analyses the Rx speech (coming from remote party). The detected DTMF symbols can be output via related URC. See the u-blox AT commands manual [2], +UDTMFD AT command, for further details.
Smart temperature supervisor ⁵	Constant monitoring of the module board temperature: <ul style="list-style-type: none"> • Warning notification when the temperature approaches an upper or lower predefined threshold • Shutdown notified and forced when the temperature value is outside the specified range (shutdown suspended in case of an emergency call in progress) The smart temperature supervisor feature can be enabled or disabled through an AT command (see the u-blox AT commands manual [2], +USTS AT command).  The sensor measures board temperature inside the shield, which can differ from ambient temperature.
Power saving	The power saving configuration is by default disabled, but it can be configured using an AT command. When power saving is enabled, the module automatically enters the low power idle-mode whenever possible, reducing current consumption. During the idle-mode, the module processor core runs with the RTC 32 kHz reference clock, which is generated by the internal 32 kHz oscillator. For more details, see the SARA-G450 system integration manual [1] and the u-blox AT commands manual [2], +UPSV AT command.
Last gasp ⁵	In case of power supply outage (i.e. main supply interruption, battery removal, battery voltage below a certain threshold) the cellular module can be configured to send an alarm notification to a remote entity. The feature can be enabled and configured through the +ULGASP AT command.

Table 3: SARA-G450 modules main supported features

 u-blox is extremely mindful of user privacy. When a position is sent to the CellLocate[®] server, u-blox is unable to track the SIM used or the specific device.

⁵ Not supported by "00" product version

2 Interfaces

2.1 Power management

2.1.1 Module supply input (VCC)

SARA-G450 modules must be supplied through the three **VCC** pins by a DC power supply. Voltages must be stable: during operation, the current drawn from **VCC** can vary by some order of magnitude, especially due to the surging consumption profile of the GSM system (described in the SARA-G450 system integration manual [1]).

SARA-G450 modules provide separate supply inputs over the three **VCC** pins:

- **VCC** pins **#52** and **#53** represent the supply input for the internal RF power amplifier, demanding most of the total current drawn of the module when RF transmission is enabled during a call
- **VCC** pin **#51** represents the supply input for the internal baseband Power Management Unit, demanding minor part of the total current drawn of the module when RF transmission is enabled during a call

It is important that the system power supply circuit is able to withstand the maximum pulse current during a transmit burst at maximum power level (see [Table 11](#)).

2.1.2 RTC supply input/output (V_BCKP)

V_BCKP is the Real Time Clock (RTC) supply of SARA-G450 modules. When **VCC** voltage is within the valid operating range, the internal Power Management Unit (PMU) supplies the RTC and the same supply voltage is available on **V_BCKP** pin. If the **VCC** voltage is under the minimum operating limit (e.g. during not powered mode), **V_BCKP** pin can externally supply the RTC.

2.1.3 Digital I/O interfaces supply output (V_INT)

SARA-G450 modules provide supply rail output on the **V_INT** pin, which is internally generated when the module is switched on. The same voltage domain is used internally to supply the generic digital I/O interfaces of the modules (UART interfaces, I2C interface and GPIO pins).

The voltage value of the **V_INT** supply output can be set to 1.8 V or 3 V according to the configuration of the **VSEL** input pin (see section [2.3.4](#)). The **V_INT** supply output can be used in place of an external regulator.

 It is recommended to provide a Test-Point connected to the **V_INT** pin for diagnostic purpose.

2.2 Antenna

2.2.1 Antenna RF interface (ANT)

The **ANT** pin has an impedance of 50 Ω and provides the RF antenna interface of SARA-G450 modules.

2.2.2 Antenna detection (ANT_DET)

The **ANT_DET** pin is an Analog to Digital Converter (ADC) input to sense the antenna presence (as optional feature), evaluating the resistance from the **ANT** pin to GND by means of an external antenna detection circuit implemented on the application board. For more details, see the SARA-G450 system integration manual [1] and the u-blox AT commands manual [2], +UANTR AT command.

2.3 System functions

2.3.1 Module power-on (PWR_ON)

SARA-G450 modules can be switched on in one of the following ways:

- Low level on the **PWR_ON** input pin, i.e. forcing the pin (normally high due to internal pull-up) to a low level for a valid time period (see section 4.2.6). The **PWR_ON** line is intended to be driven by open drain, open collector or contact switch.
- RTC alarm, i.e. pre-programmed scheduled time (see the u-blox AT commands manual [2], +CALA AT command)

 It is recommended to provide a Test-Point connected to the **PWR_ON** pin for diagnostic purpose.

2.3.2 Module power-off

SARA-G450 modules can be properly switched off, with storage of current settings and network detach, by:

- AT+CPWROFF command (see the u-blox AT commands manual [2]).

An abrupt hardware shutdown occurs when a low level is applied to the **PWR_OFF** pin, which is normally set high, for a valid time period (see section 4.2.7), but in this case the module does not perform the storing of the current parameter settings as well as the proper network detach. The **PWR_OFF** line is intended to be driven by open drain, open collector or contact switch.

An abrupt under-voltage shutdown occurs on SARA-G450 modules when the **VCC** supply drops below the extended operating range minimum limit, but in this case it is not possible to perform the storing of the current parameter settings in the module's non-volatile memory as well as the proper network detach.

An over-temperature or an under-temperature shutdown occurs on SARA-G450 modules when the temperature measured within the cellular module reaches the dangerous area, if the optional smart temperature supervisor feature is enabled and configured by the dedicated AT command. For more details, see the SARA-G450 system integration manual [1] and the u-blox AT commands manual [2], +USTS AT command.

 The smart temperature supervisor feature is not supported by "00" product version.

 It is recommended to provide a test-point connected to the **PWR_OFF** pin for diagnostic purpose.

2.3.3 Module reset

SARA-G450 modules can be properly reset (rebooted), with storage of current parameter settings in the module's non-volatile memory and proper network detach, by:

- AT+CFUN command (see the u-blox AT commands manual [2]). This causes an “internal” or “software” reset of the module.

An abrupt hardware shutdown occurs when a low level is applied to the **PWR_OFF** pin, which is normally set high, for a valid time period (see section 4.2.7), but in this case the module does not perform the storing of the current parameter settings in the module's non-volatile memory as well as the proper network detach. The module can be subsequently rebooted forcing a low level at the **PWR_ON** input pin for a valid time period (see section 4.2.6).

2.3.4 Digital I/O interfaces voltage selection (VSEL)

The digital I/O interfaces of SARA-G450 modules (the UART interfaces, I2C interface and GPIO pins) can operate at 1.8 V or 3 V voltage rail. The operating voltage can be selected using the **VSEL** input pin:

- If **VSEL** input pin is connected to GND, the digital I/O interfaces operate at 1.8 V
- If **VSEL** input pin is left unconnected, the digital I/O interfaces operate at 3 V

The operating voltage cannot be changed dynamically: the **VSEL** input pin configuration has to be set before the boot of SARA-G450 modules and then it cannot be changed after switched on.

2.4 SIM

2.4.1 (U)SIM interface

A (U)SIM card interface is available via the **VSIM**, **SIM_IO**, **SIM_CLK**, **SIM_RST** pins of SARA-G450 modules for the direct connection of an external SIM card/chip: the high-speed SIM/ME interface is implemented as well as the automatic detection of the required SIM supporting voltage.

Both 1.8 V and 3 V SIM types are supported: activation and deactivation with automatic voltage switch from 1.8 V to 3 V are implemented, according to ISO-IEC 7816-3 specifications.

2.4.2 SIM card detection (SIM_DET)

The **SIM_DET** pin of SARA-G450 modules is a digital input provided to sense the SIM card presence (as an optional feature), when it is properly connected to the mechanical switch of the SIM card holder (for more details see the SARA-G450 system integration manual [1]).

2.5 Serial interfaces

SARA-G450 modules provide the following serial communication interfaces:

- UART interface: 9-wire unbalanced 1.8 V / 3 V asynchronous serial interface supporting:
 - AT command mode⁶
 - Data mode and online command mode⁶
 - MUX functionality, including dedicated GNSS tunneling virtual channel⁷
 - FW upgrades by means of the FOAT feature
- Secondary auxiliary UART interface⁸: 3-wire unbalanced 1.8 V / 3 V asynchronous serial interface supporting:
 - AT command mode⁶
 - Data mode and online command mode⁶
 - GNSS tunneling
- Additional UART interface for FW upgrade and tracing: 3-wire unbalanced 1.8 V / 3 V asynchronous serial interfaces supporting:
 - FW upgrades by means of the dedicated tool
 - Trace log capture (diagnostic purpose)
- DDC interface⁹: I2C-bus compatible 1.8 V / 3 V interface supporting:
 - Communication with u-blox GNSS positioning chips / modules

2.5.1 Asynchronous serial interface (UART)

The UART interface is a 9-wire unbalanced asynchronous serial interface, supporting:

- AT command mode⁶
- Data mode and online command mode⁶
- MUX functionality (see 2.5.1.1)
- FW upgrades by means of the FOAT feature

UART characteristics are:

- Complete serial port with RS-232 functionality conforming to ITU-T V.24 recommendation [5], with CMOS compatible signal levels (0 V for low data bit or ON state and 1.8 V / 3 V for high data bit or OFF state)
- Data lines (**RXD** as output, **TXD** as input), hardware flow control lines (**CTS** as output, **RTS** as input), modem status and control lines (**DTR** as input, **DSR** as output, **DCD** as output, **RI** as output) are provided
- Hardware flow control (default value) or none flow control are supported
- Power saving indication available on the hardware flow control output (**CTS** line): the line is driven to the OFF state when the module is not ready to accept data signals
- 2400, 4800, 9600, 19200, 38400, 57600, 115200 bit/s baud rates are supported
- One-shot auto baud rate detection (autobauding) is the default configuration
- Frame format can be: 8N1 (8 data bits, no parity, 1 stop bit), or 8N2 (8 data bits, no parity, 2 stop bits), or 8E1 (8 data bits, even parity, 1 stop bit), or 8O1 (8 data bits, odd parity, 1 stop bit)
- Default frame configuration is 8N1 (8 data bits, no parity, 1 stop bit)

⁶ See the u-blox AT commands manual [2] for the definition of the command mode, data mode, and online command mode.

⁷ GNSS tunneling is not supported by “00” product version

⁸ Secondary auxiliary UART interface is not supported by “00” product version.

⁹ DDC I2C-bus compatible interface is not supported by “00” product version.

2.5.1.1 Multiplexer protocol

SARA-G450 modules have a software layer with MUX functionality, 3GPP TS 27.010 [8], available on the UART physical link. This is a data link protocol (layer 2 of OSI model) which uses HDLC-like framing and operates between the module (DCE) and the application processor (DTE), and allows a number of simultaneous sessions over the physical link (UART): the user can concurrently use AT command interface on one MUX channel and data communication on another MUX channel.

SARA-G450 modules define the following virtual channels:

- Channel 0: control channel
- Channel 1 – 5: AT and data
- Channel 6: GNSS tunneling¹⁰

2.5.2 Secondary auxiliary asynchronous serial interface (AUX UART)

 Secondary auxiliary UART interface is not supported by “00” product version.

The secondary auxiliary UART interface (AUX UART) is a 3-wire unbalanced asynchronous serial interface, supporting:

- AT command mode¹¹
- Data mode and online command mode¹¹
- GNSS tunneling mode

AUX UART characteristics are:

- Serial port with RS-232 functionality conforming to ITU-T V.24 recommendation [5], with CMOS compatible levels: 0 V for low data bit or ON state and 1.8 V / 3 V for high data bit or OFF state
- Data lines (**RXD_AUX** as output, **TXD_AUX** as input) are provided
- Characteristics in command mode, data mode, and online command mode:
 - Baud rate can be: 2400, 4800, 9600, 19200, 38400, 57600, 115200 bit/s, with default value 115200 bit/s
 - Frame format can be: 8N1, or 8N2, or 8E1, or 8O1, with default value 8N1
 - Automatic baud rate detection (autobauding) and automatic frame format recognition are not supported
 - None flow control is supported
- Characteristics in GNSS tunneling mode:
 - Baud rate is 115200 bit/s
 - Frame format is 8N1 (8 data bits, no parity, 1 stop bit)
 - None flow control is supported

¹⁰ Not supported by “00” product version

¹¹ For the definition of the command mode, data mode, and online command mode, see the u-blox AT commands manual [2].

2.5.3 Additional asynchronous serial interface for FW upgrade and tracing (FT UART)

The additional UART interface for Firmware upgrade and Tracing (FT UART) is a 3-wire unbalanced asynchronous serial interface, supporting:

- FW upgrades by means of the dedicated tool
- Trace log capture (diagnostic purpose)
- RF non-signaling test mode by means of dedicated commands

FT UART characteristics are:

- Serial port with RS-232 functionality conforming to ITU-T V.24 recommendation [5], with CMOS compatible levels: 0 V for low data bit or ON state and 1.8 V / 3 V for high data bit or OFF state
- Data lines (**RXD_FT** as output, **TXD_FT** as input)
- Software flow control (XON/XOFF)
- Fixed baud-rate 921600 b/s
- Fixed frame format 8N1 (8 data bits, no parity, 1 stop bit)

 It is highly recommended to provide test-points connected to the **RXD_FT** and **TXD_FT** pins for FW upgrades and diagnostic purpose.

2.5.4 DDC (I2C compatible) interface

 DDC (I2C compatible) interface is not supported by “00” product version.

SARA-G450 modules provide an I2C compatible DDC interface on the **SCL** and **SDA** pins exclusively for the communication with u-blox GNSS positioning chips / modules.

2.6 Audio interface

 Analog audio interface is not supported by “00” product version.

SARA-G450 modules provide an analog audio interface:

- Analog audio input:
 - Differential analog audio input (**MIC_P**, **MIC_N**) shared for all the analog audio path modes: the pins can be connected to the output of an external analog audio device or can be connected to an external microphone by means of a simple circuit implemented on the application board
 - Supply output for an external microphone (**MIC_BIAS**): the pin can provide the bias to an external microphone by means of a simple circuit implemented on the application board
 - Local ground for the external microphone (**MIC_GND**): the pin can provide the reference for the differential analog audio input as sense ground line for the external microphone circuit
- Analog audio output:
 - Differential audio output (**SPK_P**, **SPK_N**) shared for all the analog audio path modes: the pins can be connected to the input of an external analog audio device or can be connected to an external speaker

2.7 GPIO

SARA-G450 modules provide 4 GPIO pins (**GPIO1-GPIO4**) that can be configured for general purpose input/output, or to provide custom functions via u-blox AT commands (for further details, see the SARA-G450 system integration manual [1] and the u-blox AT commands manual [2], +UGPIOC, +UGPIOR, +UGPIOW).

Table 4 summarizes the custom functions available on the GPIO pins of SARA-G450 modules.

Function	Description	Default GPIO	Configurable GPIOs
Network status indication	Network status: registered home network, registered roaming, data transmission, no service	--	GPIO1, GPIO2, GPIO3, GPIO4
External GNSS supply enable ¹²	Output to enable/disable the supply of an external u-blox GNSS receiver connected to the cellular module by the DDC (I2C) interface	GPIO2 ¹²	GPIO1 ¹² , GPIO2 ¹² , GPIO3 ¹² , GPIO4 ¹²
Last gasp ¹²	Input to trigger last gasp notification	--	GPIO1 ¹² , GPIO2 ¹² , GPIO3 ¹² , GPIO4 ¹²
32.768 kHz output	32.768 kHz clock output	--	GPIO3
General purpose input	Input to sense high or low digital level	--	GPIO1, GPIO2, GPIO3, GPIO4
General purpose output	Output to set high or low digital level	--	GPIO1, GPIO2, GPIO3, GPIO4
Pin disabled	Tri-state with an internal active pull-down enabled	GPIO1, GPIO2 ¹³ , GPIO3, GPIO4	GPIO1, GPIO2, GPIO3, GPIO4

Table 4: GPIO custom functions configuration

¹² Not supported by "00" product version

¹³ "00" product version only

3 Pin definition

3.1 Pin assignment

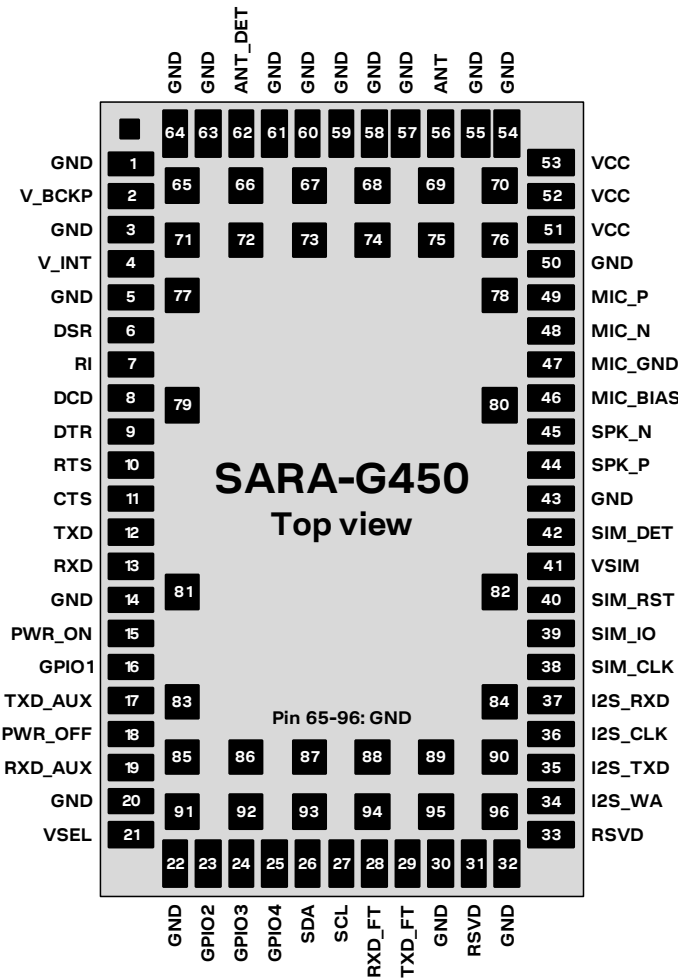

Figure 2: SARA-G450 modules – pin assignments

No	Name	Power domain	I/O	Description	Remarks
1	GND	-	N/A	Ground	All the GND pads must be connected to ground.
2	V_BCKP	-	I/O	Real Time Clock supply input/output	V_BCKP = 3.1 V (typical) generated by the module to supply the Real Time Clock when VCC supply voltage is within valid operating range. See section 4.2.2 for detailed electrical specs.
3	GND	-	N/A	Ground	All the GND pads must be connected to ground.
4	V_INT	-	O	Digital I/O Interfaces supply output	V_INT supply output, rail of the Digital I/O Interfaces, generated by the module when it is switched-on. V_INT = 1.8 V (typical), if VSEL is connected to GND. V_INT = 3 V (typical), if VSEL is unconnected. Test-point recommended for diagnostic purpose. See section 4.2.2 for detailed electrical specs.
5	GND	-	N/A	Ground	All the GND pads must be connected to ground.
6	DSR	GDI	O	UART data set ready	Circuit 107 (DSR) in ITU-T V.24. PU/PD class b. Value at reset: T/PD See section 4.2.9 for detailed electrical specs.

No	Name	Power domain	I/O	Description	Remarks
7	RI	GDI	O	UART ring indicator	Circuit 125 (RI) in ITU-T V.24. PU/PD class b. Value at reset: T/PD See section 4.2.9 for detailed electrical specs.
8	DCD	GDI	O	UART data carrier detect	Circuit 109 (DCD) in ITU-T V.24. PU/PD class b. Value at reset: T/PD See section 4.2.9 for detailed electrical specs.
9	DTR	GDI	I	UART data terminal ready	Circuit 108/2 (DTR) in ITU-T V.24. Internal active pull-up enabled. PU/PD class b. Value at reset: T/PD See section 4.2.9 for detailed electrical specs.
10	RTS	GDI	I	UART request to send	Circuit 105 (RTS) in ITU-T V.24. Internal active pull-up enabled. PU/PD class b. Value at reset: T/PD See section 4.2.9 for detailed electrical specs.
11	CTS	GDI	O	UART clear to send	Circuit 106 (CTS) in ITU-T V.24. PU/PD class b. Value at reset: T/PD See section 4.2.9 for detailed electrical specs.
12	TXD	GDI	I	UART transmitted data	Circuit 103 (TxD) in ITU-T V.24. Internal active pull-up enabled. PU/PD class b. Value at reset: T/PD See section 4.2.9 for detailed electrical specs.
13	RXD	GDI	O	UART received data	Circuit 104 (RxD) in ITU-T V.24. PU/PD class b. Value at reset: T/PD See section 4.2.9 for detailed electrical specs.
14	GND	-	N/A	Ground	All the GND pads must be connected to ground.
15	PWR_ON	PON	I	Power-on input	Internal active pull-up to 2.5 V internal supply. Test-Point recommended for diagnostic purpose. See section 4.2.6 for detailed electrical specs.
16	GPIO1	GDI	I/O	GPIO	Configurable GPIO: see Table 4 for the available custom functions. PU/PD class a. Value at reset: T/PD See section 4.2.9 for detailed electrical specs.
17	TXD_AUX	GDI	I	AUX UART transmitted data	Circuit 103 (TxD) in ITU-T V.24. Internal active pull-up enabled. PU/PD class b. Value at reset: T/PD Not supported by "00" product version. See section 4.2.9 for detailed electrical specs.
18	PWR_OFF	POF	I	Power-off input	Internally connected to 1.5 V internal supply. Test-Point recommended for diagnostic purpose. See section 4.2.7 for detailed electrical specs.
19	RXD_AUX	GDI	O	AUX UART received data	Circuit 104 (RxD) in ITU-T V.24. PU/PD class b. Value at reset: T/PD Not supported by "00" product version. See section 4.2.9 for detailed electrical specs.
20	GND	-	N/A	Ground	All the GND pads must be connected to ground.
21	VSEL	-	I	Voltage selection	Input to select the operating voltage of the digital I/O interfaces of the module (the UART interfaces, I2C interface and GPIO pins). V _{INT} = 1.8 V (typical), if VSEL is connected to GND. V _{INT} = 3 V (typical), if VSEL is unconnected.
22	GND	-	N/A	Ground	All the GND pads must be connected to ground.





No	Name	Power domain	I/O	Description	Remarks
23	GPIO2	GDI	I/O	GPIO	Configurable GPIO: see Table 4 for the available custom functions. PU/PD class b. Value at reset: T/PD See section 4.2.9 for detailed electrical specs.
24	GPIO3	GDI	I/O	GPIO	Configurable GPIO: see Table 4 for the available custom functions. PU/PD class b. Value at reset: T/PD See section 4.2.9 for detailed electrical specs.
25	GPIO4	GDI	I/O	GPIO	Configurable GPIO: see Table 4 for the available custom functions. PU/PD class b. Value at reset: T/PD See section 4.2.9 for detailed electrical specs.
26	SDA	DDC	I/O	I2C bus data line	Fixed open drain. No internal pull-up. Value at reset: T Not supported by "00" product version. See section 4.2.10 for detailed electrical specs.
27	SCL	DDC	O	I2C bus clock line	Fixed open drain. No internal pull-up. Value at reset: T Not supported by "00" product version. See section 4.2.10 for detailed electrical specs.
28	RXD_FT	GDI	O	FT UART received data	Circuit 104 (RxD) in ITU-T V.24. PU/PD class b. Value at reset: T/PU Test-Point recommended for diagnostic purpose. See section 4.2.9 for detailed electrical specs.
29	TXD_FT	GDI	I	FT UART transmitted data	Circuit 103 (TxD) in ITU-T V.24. Internal active pull-up enabled. PU/PD class b. Value at reset: T/PU Test-Point recommended for diagnostic purpose. See section 4.2.9 for detailed electrical specs.
30	GND	-	N/A	Ground	All the GND pads must be connected to ground.
31	RSVD	-	N/A	RESERVED pin	Internally not connected. Leave unconnected.
32	GND	-	N/A	Ground	All the GND pads must be connected to ground.
33	RSVD	-	N/A	RESERVED pin	This pin can be connected to GND or it can be left unconnected.
34	I2S_WA	GDI	O	I ² S word alignment	Not supported.
35	I2S_TXD	GDI	O	I2S transmit data	Not supported.
36	I2S_CLK	GDI	O	I2S clock	Not supported.
37	I2S_RXD	GDI	I	I2S receive data	Not supported.
38	SIM_CLK	SIM	O	SIM clock	Value at reset: L See section 4.2.8 for detailed electrical specs.
39	SIM_IO	SIM	I/O	SIM data	Internal 4.7k pull-up to VSIM. Value at reset: T See section 4.2.8 for detailed electrical specs.
40	SIM_RST	SIM	O	SIM reset	Value at reset: L See section 4.2.8 for detailed electrical specs.
41	VSIM	-	O	SIM supply output	VSIM = 1.8 V typical, if external SIM = 1.8 V type. VSIM = 2.8 V typical, if external SIM = 3.0 V type. See section 4.2.2 for detailed electrical specs.
42	SIM_DET	GDI	I	SIM detection	SIM card presence detection function. Internal active pull-down enabled. PU/PD class b. Value at reset: T/PD See section 4.2.9 for detailed electrical specs.
43	GND	-	N/A	Ground	All the GND pads must be connected to ground.

No	Name	Power domain	I/O	Description	Remarks
44	SPK_P	AUDIO	O	Differential analog audio output (positive)	Differential analog audio output. Not supported by "00" product version. See section 4.2.11 for detailed electrical specs.
45	SPK_N	AUDIO	O	Differential analog audio output (negative)	Differential analog audio output. Not supported by "00" product version. See section 4.2.11 for detailed electrical specs.
46	MIC_BIAS	AUDIO	O	Microphone supply output	Supply output for the external microphone. Not supported by "00" product version. See section 4.2.11 for detailed electrical specs.
47	MIC_GND	AUDIO	I	Microphone analog reference	Local ground for the external microphone (reference for the differential analog audio input). Not supported by "00" product version. See section 4.2.11 for detailed electrical specs.
48	MIC_N	AUDIO	I	Differential analog audio input (negative)	Differential analog audio input. Not supported by "00" product version. See section 4.2.11 for detailed electrical specs.
49	MIC_P	AUDIO	I	Differential analog audio input (positive)	Differential analog audio input. Not supported by "00" product version. See section 4.2.11 for detailed electrical specs.
50	GND	-	N/A	Ground	All the GND pads must be connected to ground.
51	VCC	-	I	Module supply input	All VCC pins must be connected to external supply. Supply input for internal Base-Band PMU and transceiver. See sections 4.2.2, 4.2.3 for detailed electrical spec.
52	VCC	-	I	Module supply input	All VCC pins must be connected to external supply. Supply input for the internal RF Power Amplifier. See sections 4.2.2, 4.2.3 for detailed electrical spec.
53	VCC	-	I	Module supply input	All VCC pins must be connected to external supply. Supply input for the internal RF Power Amplifier. See sections 4.2.2, 4.2.3 for detailed electrical spec.
54	GND	-	N/A	Ground	All the GND pads must be connected to ground.
55	GND	-	N/A	Ground	All the GND pads must be connected to ground.
56	ANT	-	I/O	RF antenna	50 Ω nominal impedance See section 4.2.4 for detailed electrical specs.
57	GND	-	N/A	Ground	All the GND pads must be connected to ground.
58	GND	-	N/A	Ground	All the GND pads must be connected to ground.
59	GND	-	N/A	Ground	All the GND pads must be connected to ground.
60	GND	-	N/A	Ground	All the GND pads must be connected to ground.
61	GND	-	N/A	Ground	All the GND pads must be connected to ground.
62	ANT_DET	ADC	I	Antenna detection	Antenna presence detection function. See section 4.2.5 for detailed electrical specs.
63	GND	-	N/A	Ground	All the GND pads must be connected to ground.
64	GND	-	N/A	Ground	All the GND pads must be connected to ground.
65-96	GND	-	N/A	Ground	All the GND pads must be connected to ground.

Table 5: SARA-G450 module pin-out

For an explanation of abbreviations and terms used, see appendix A.

4 Electrical specifications

-  Stressing the device above one or more of the ratings listed in the Absolute Maximum Rating section may cause permanent damage. These are stress ratings only. Operating the module at these or at any conditions other than those specified in the Operating Conditions sections (chapter 4.2) of the specification should be avoided. Exposure to Absolute Maximum Rating conditions for extended periods may affect device reliability.
-  Operating conditions ranges define those limits within which the functionality of the device is guaranteed.
-  Electrical characteristics are defined according to the verification on a representative number of samples or according to the simulation.
-  Where application information is given, it is advisory only and does not form part of the specification.

4.1 Absolute maximum rating

-  Limiting values given below are in accordance with Absolute Maximum Rating System (IEC 134).

Symbol	Description	Condition	Min	Max	Unit
VCC	Module supply voltage	Input DC voltage at VCC pins	-0.15	5.0	V
V_BCKP	RTC supply voltage	Input DC voltage at V_BCKP pin	-0.15	3.5	V
GDI	Generic digital interfaces	Input DC voltage at Generic digital interfaces pins	-0.15	3.3	V
DDC	DDC interface	Input DC voltage at DDC interface pins	-0.15	3.3	V
SIM	SIM interface	Input DC voltage at SIM interface pins	-0.15	3.3	V
PON	Power-on signal	Input DC voltage at PWR_ON pin	-0.15	5.0	V
POF	Power-off signal	Input DC voltage at PWR_OFF pin	-0.15	5.0	V
AUDIO	Audio pins	Input DC voltage at Audio pins	-0.15	3.3	V
ADC	Antenna detection pin	Input DC voltage at ANT_DET pin	-0.15	2.3	V
Rho_ANT	Antenna ruggedness	Output RF load mismatch ruggedness at ANT pin		20:1	VSWR
Tstg	Storage temperature range		-40	+85	°C

Table 6: Absolute maximum ratings

-  The product is not protected against overvoltage or reversed voltages. If necessary, voltage spikes exceeding the voltage specifications, given in table above, must be limited to values within the specified boundaries by using appropriate protection devices.

4.1.1 Maximum ESD

Parameter	Min	Typical	Max	Unit	Remarks
ESD sensitivity for all pins except ANT pin			1000	V	Human Body Model according to JESD22-A114
ESD sensitivity for ANT pin			1000	V	Human Body Model according to JESD22-A114
ESD immunity for ANT pin			4000	V	Contact Discharge according to IEC 61000-4-2
			8000	V	Air Discharge according to IEC 61000-4-2

Table 7: Maximum ESD ratings

u-blox cellular modules are Electrostatic Sensitive Devices (ESD) and require special precautions when handling. See section 7.4 for ESD handling instructions.

4.2 Operating conditions

Unless otherwise specified, all operating condition specifications are at an ambient temperature of 25°C.

Operation beyond the operating conditions is not recommended and extended exposure beyond them may affect device reliability.

4.2.1 Operating temperature range

Parameter	Min	Typical	Max	Unit	Remarks
Normal operating temperature	-20	+25	+70	°C	Normal operating temperature range (fully functional and meet 3GPP specifications)
Extended operating temperature	-40		+85	°C	Extended operating temperature range (RF performance may be affected outside normal operating range, though module is fully functional)

Table 8: Environmental conditions

4.2.2 Supply/Power pins

Symbol	Parameter	Min	Typical	Max	Unit
VCC	Module supply normal operating voltage ¹⁴	3.4	3.8	4.2	V
	Module supply extended operating voltage ¹⁵	3.1		4.5	V
V_BCKP	Real Time Clock Supply input voltage	2.6		3.3	V
I_BCKP	Real Time Clock Supply average current consumption, at V_BCKP = 3.1 V		185		µA

Table 9: Input characteristics of Supply/Power pins

Symbol	Parameter	Min	Typical	Max	Unit
VSIM	SIM interface supply output voltage, external SIM = 1.8V type		1.80		V
	SIM interface supply output voltage, external SIM = 3.0V type		2.80		V

¹⁴ The input voltage at the related **VCC** pins of the module must be above the normal operating range minimum limit to switch-on the module. RF performance may be affected when the input voltage at the **VCC** pins of the module goes outside the normal operating range limits, though the module is still fully functional.

¹⁵ Module may switch off when the input voltage at the related **VCC** pins of the module drops below the extended operating range minimum limit.

Symbol	Parameter	Min	Typical	Max	Unit
V_BCKP	Real Time Clock supply output voltage		3.1		V
I_BCKP	Real Time Clock supply output current capability			1.6	mA
V_INT	Digital I/O Interfaces supply output voltage, VSEL = GND		1.80		V
	Digital I/O Interfaces supply output voltage, VSEL unconnected		3.00		V
I_INT	Digital I/O Interfaces supply output current capability			70	mA

Table 10: Output characteristics of Supply/Power pins

4.2.3 Current consumption

Mode	Condition	Tx power	Min	Typical ¹⁶	Max ¹⁷	Unit
Power Off Mode (module switched off)	Averaged current value	--		0.1		mA
Idle-Mode (low power mode enabled)	Averaged current value (AT+UPSV=1, AT+COPS=2)	--		1.0		mA
Cyclic Idle/Active-Mode (low power mode enabled)	Averaged current value (AT+UPSV=2, DRX = 9 ¹⁸)	--		1.2		mA
	Averaged current value (AT+UPSV=1, DRX = 5 ¹⁹)	--		1.5		mA
Active-Mode (low power mode disabled)	Averaged current value (AT+UPSV=0, DRX = 5 ¹⁹)	--		8.9		mA
Connected Mode (Tx / Rx in progress)	Averaged current value, 1 Tx + 1 Rx slot 850 MHz / 900 MHz operating bands	Minimum		65		mA
	Averaged current value, 1 Tx + 1 Rx slot 1800 MHz / 1900 MHz operating bands	Minimum		65		mA
	Averaged current value, 1 Tx + 1 Rx slot 850 MHz / 900 MHz operating bands	Maximum		230		mA
	Averaged current value, 1 Tx + 1 Rx slot 1800 MHz / 1900 MHz operating bands	Maximum		150		mA
	Averaged current value, 2 Tx + 3 Rx slot 850 MHz / 900 MHz operating bands	Maximum		285		mA
	Averaged current value, 2 Tx + 3 Rx slot 1800 MHz / 1900 MHz operating bands	Maximum		205		mA
	Pulse current value ²⁰ during 1-slot Tx burst, 850 MHz / 900 MHz operating bands	Maximum		1.5	1.9	A

Table 11: VCC current consumption

¹⁶ Typical values with a matched antenna.

¹⁷ Maximum values with a mismatched antenna.

¹⁸ Module is registered with the network, with a paging period of 2.12 s (2G network DRX setting = 9).

¹⁹ Module is registered with the network, with a paging period of 1.18 s (2G network DRX setting = 5).

²⁰ Use this figure to dimension maximum current capability of power supply.

4.2.4 RF performance

Parameter		Min	Max	Unit	Remarks
Frequency range GSM 850	Uplink	824	849	MHz	Module transmit
	Downlink	869	894	MHz	Module receive
Frequency range E-GSM 900	Uplink	880	915	MHz	Module transmit
	Downlink	925	960	MHz	Module receive
Frequency range DCS 1800	Uplink	1710	1785	MHz	Module transmit
	Downlink	1805	1880	MHz	Module receive
Frequency range PCS 1900	Uplink	1850	1910	MHz	Module transmit
	Downlink	1930	1990	MHz	Module receive

Table 12: Operating RF frequency bands

Parameter	Min	Typical	Max	Unit	Remarks
Receiver input sensitivity: GSM 850		-109		dBm	Downlink RF level @ BER Class II < 2.4 %
Receiver input sensitivity: E-GSM 900		-109		dBm	Downlink RF level @ BER Class II < 2.4 %
Receiver input sensitivity: DCS 1800		-109		dBm	Downlink RF level @ BER Class II < 2.4 %
Receiver input sensitivity: PCS 1900		-109		dBm	Downlink RF level @ BER Class II < 2.4 %

Table 13: Receiver sensitivity performance with condition: 50 Ω source

4.2.5 ANT_DET pin

Pin Name	Parameter	Min	Typical	Max	Unit	Remarks
ANT_DET	Output DC current pulse value		75		μA	
	Output DC current pulse time length	12	13	14	ms	

Table 14: ANT_DET pin characteristics

4.2.6 PWR_ON pin

Pin Name	Parameter	Min	Typical	Max	Unit	Remarks
PWR_ON	Supply for Power-On Input Signal		2.5		V	Internal supply
	Pull-up resistance		28		kΩ	Internal active pull-up
	L-level input	0.0		0.3	V	
	H-level input	1.8		2.5	V	
	L-level input current			86	μA	
	PWR_ON low time to switch-on the module	2			s	

Table 15: PWR_ON pin characteristics

4.2.7 PWR_OFF pin

Pin Name	Parameter	Min	Typical	Max	Unit	Remarks
PWR_OFF	Supply for Power-Off Input Signal		1.5		V	Internal supply
	L-level input	0.0		0.1	V	
	H-level input	1.2		1.5	V	
	PWR_OFF low time to switch-off the module	100			ms	

Table 16: PWR_OFF pin characteristics

4.2.8 SIM pins

Parameter	Min	Typical	Max	Unit	Remarks
Low-level input	0.00		0.48	V	External SIM type = 1.8 V
	0.00		0.78	V	External SIM type = 3.0 V
High-level input	1.40		2.00	V	External SIM type = 1.8 V
	2.10		3.00	V	External SIM type = 3.0 V
Low-level output		0.00		V	External SIM type = 1.8 V
		0.00		V	External SIM type = 3.0 V
High-level output		1.80		V	External SIM type = 1.8 V
		2.80		V	External SIM type = 3.0 V
Internal pull-up resistor on SIM_IO to VSIM		4.7		k Ω	
Clock frequency on SIM_CLK		3.25		MHz	

Table 17: SIM pins characteristics

4.2.9 Generic Digital Interfaces pins

Parameter	Min	Typical	Max	Unit	Remarks
Internal supply for GDI domain	1.80			V	Digital Interfaces supply (V_INT). VSEL connected to GND
	3.00			V	Digital Interfaces supply (V_INT). VSEL unconnected
	2.80			V	Digital Interfaces supply (V_INT). During firmware upgrade
Low-level input	0.00		0.48	V	VSEL connected to GND
	0.00		0.84	V	VSEL unconnected
	0.00		0.78	V	During firmware upgrade
High-level input	1.40		2.00	V	VSEL connected to GND
	2.24		3.20	V	VSEL unconnected
	2.10		3.00	V	During firmware upgrade
Low-level output		0.00		V	VSEL connected to GND
		0.00		V	VSEL unconnected
		0.00		V	During firmware upgrade
High-level output		1.80		V	VSEL connected to GND
		3.00		V	VSEL unconnected
		2.80		V	During firmware upgrade
Output driver strength			3	mA	
Pull-up / Pull-down value		33		k Ω	PU/PD class a
		166		k Ω	PU/PD class b

Table 18: GDI pins characteristics

4.2.10 DDC (I2C) pins

Parameter	Min	Typical	Max	Unit	Remarks
Internal supply for DDC domain	1.80			V	Digital Interfaces supply (V_INT). VSEL connected to GND
		3.00		V	Digital Interfaces supply (V_INT). VSEL unconnected
Low-level input	0.00		0.48	V	VSEL connected to GND
	0.00		0.84	V	VSEL unconnected
High-level input	1.40		2.00	V	VSEL connected to GND
	2.24		3.20	V	VSEL unconnected
Low-level output		0.00		V	VSEL connected to GND
		0.00		V	VSEL unconnected
Output driver strength			3	mA	
Clock frequency on SCL		100		kHz	

Table 19: DDC pins characteristics

4.2.11 Audio pins

Pin name	Parameter	Min	Typical	Max	Unit	Remarks
MIC_BIAS	Microphone supply output voltage		1.8		V	Provided by MIC_BIAS output pin with MIC_GND pin as reference.
	Microphone supply output current			0.5	mA	Provided by MIC_BIAS output pin with MIC_GND pin as reference
	Load capacitance			0	nF	Proper internal bypass capacitor is already provided to guarantee stable operation: an external capacitor directly connected to MIC_BIAS pin is not necessary, but can be provided after a proper series resistor.
	Load resistance	4			k Ω	
MIC_GND	Microphone ground		0		V	MIC_GND pin is internally connected to GND as a sense line

Table 20: Microphone supply (MIC_BIAS) characteristics

Pin name	Parameter	Min	Typical	Max	Unit	Remarks
MIC_P/MIC_N	Differential input voltage			0.28	V _{pp}	Gain = 21 dB
	Differential input resistance		4		k Ω	
	Pseudo-differential mode DC voltage at MIC_N		0.0		V	Measured in open circuit condition No internal DC blocking capacitor
	Pseudo-differential mode DC voltage at MIC_P		2.0		V	Measured in open circuit condition No internal DC blocking capacitor
	Input capacitance		68		pF	No internal DC blocking capacitor
	Signal to noise		65		dB	Gain stage = +21 dB, Bandwidth 1 kHz
	Signal to distortion (THD)		70		dB	
	Power supply rejection		60		dB	

Table 21: Differential audio transmit path (MIC_P, MIC_N) input characteristics

Pin name	Parameter	Min	Typical	Max	Unit	Remarks
SPK_P/SPK_N	Maximum differential output voltage			3.6	V _{pp}	Load = 33 μ H + 32 Ω + 33 μ H
	Common mode output voltage		1.4		V	
	Output current limit			100	mA	
	Output load resistance	14			Ω	
	Single-ended output load capacitance		10		μ F	
	Signal to noise			48		dB
	Signal to distortion (THD)			49		dB

Table 22: Differential audio receive path (SPK_P, SPK_N) output characteristics

5 Mechanical specifications

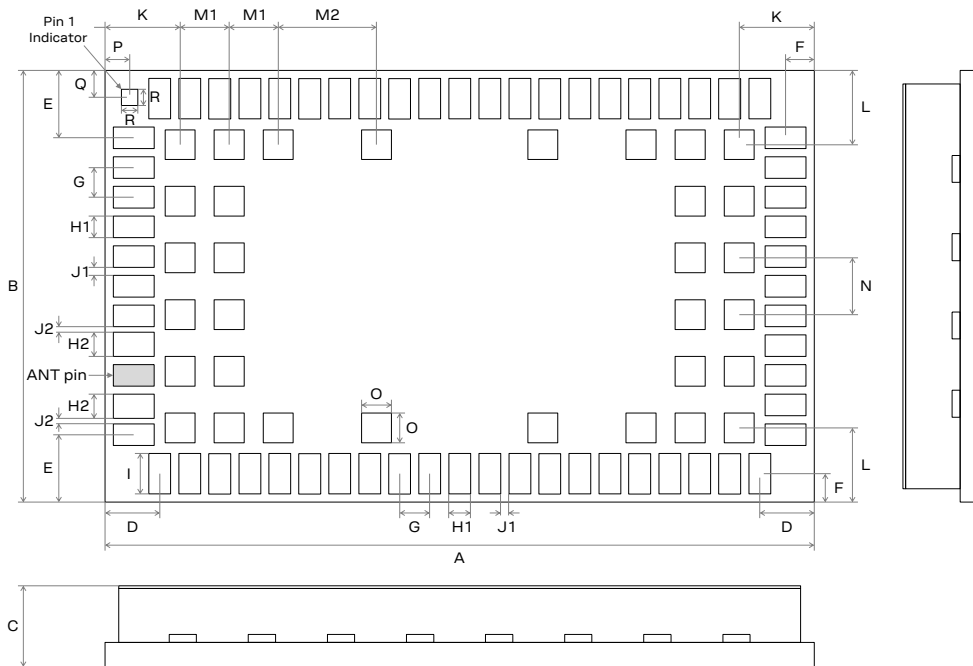





Figure 3: SARA-G450 module dimensions (bottom and sides views)

Parameter	Description	Typical	Tolerance
A	Module height [mm]	26.0 (1023.6 mil)	+0.20/-0.20 (+7.9/-7.9 mil)
B	Module width [mm]	16.0 (629.9 mil)	+0.20/-0.20 (+7.9/-7.9 mil)
C	Module thickness [mm]	2.4 (94.5 mil)	+0.25/-0.15 (+9.8/-5.9 mil)
D	Horizontal edge to lateral pin pitch [mm]	2.0 (78.7 mil)	+0.20/-0.20 (+7.9/-7.9 mil)
E	Vertical edge to lateral pin pitch [mm]	2.5 (98.4 mil)	+0.20/-0.20 (+7.9/-7.9 mil)
F	Edge to lateral pin pitch [mm]	1.05 (41.3 mil)	+0.20/-0.20 (+7.9/-7.9 mil)
G	Lateral pin to pin pitch [mm]	1.1 (43.3 mil)	+0.05/-0.05 (+2.0/-2.0 mil)
H1	Lateral pin height [mm]	0.8 (31.5 mil)	+0.05/-0.05 (+2.0/-2.0 mil)
H2	Lateral pin close to ANT height [mm]	0.9 (35.4 mil)	+0.05/-0.05 (+2.0/-2.0 mil)
I	Lateral pin width [mm]	1.5 (59.1 mil)	+0.05/-0.05 (+2.0/-2.0 mil)
J1	Lateral pin to pin distance [mm]	0.3 (11.8 mil)	+0.05/-0.05 (+2.0/-2.0 mil)
J2	Lateral pin to pin close to ANT distance [mm]	0.2 (7.9 mil)	+0.05/-0.05 (+2.0/-2.0 mil)
K	Horizontal edge to central pin pitch [mm]	2.75 (108.3 mil)	+0.20/-0.20 (+7.9/-7.9 mil)
L	Vertical edge to central pin pitch [mm]	2.75 (108.3 mil)	+0.20/-0.20 (+7.9/-7.9 mil)
M1	Central pin to pin horizontal pitch [mm]	1.8 (70.9 mil)	+0.05/-0.05 (+2.0/-2.0 mil)
M2	Central pin to pin horizontal pitch [mm]	3.6 (141.7 mil)	+0.05/-0.05 (+2.0/-2.0 mil)
N	Central pin to pin vertical pitch [mm]	2.1 (82.7 mil)	+0.05/-0.05 (+2.0/-2.0 mil)
O	Central pin height and width [mm]	1.1 (43.3 mil)	+0.05/-0.05 (+2.0/-2.0 mil)
P	Horizontal edge to pin 1 indicator pitch [mm]	0.9 (35.4 mil)	+0.20/-0.20 (+7.9/-7.9 mil)
Q	Vertical edge to pin 1 indicator pitch [mm]	1.0 (39.4 mil)	+0.20/-0.20 (+7.9/-7.9 mil)
R	Pin 1 indicator height and width [mm]	0.6 (23.6 mil)	+0.05/-0.05 (+2.0/-2.0 mil)
Weight	Module weight [g]	< 3	

Table 23: SARA-G450 module dimensions

-  Module height tolerance ± 0.20 mm may be exceeded close to the corners of the PCB due to cutting process: in worst case the Height could be $+0.40$ mm longer than the typical value.
-  All the pads of SARA-G450 modules are designed with Cu base material and electroless nickel immersion gold surface finish (Ni > 2.54 μm / Au > 0.03 μm).
-  For information regarding suggested footprint (copper mask) and stencil (paste mask) layout to be implemented on the application board, see the SARA-G450 system integration manual [\[1\]](#).

6 Qualification and approvals

6.1 Reliability tests

Tests for product family qualifications are according to ISO 16750 “Road vehicles – Environmental conditions and testing for electrical and electronic equipment“, and appropriate standards.

6.2 Approvals

SARA-G450 modules comply with the directive 2011/65/EU of the European Parliament and the Council on the Restriction of Use of certain Hazardous Substances in Electrical and Electronic Equipment (EU RoHS 2) and its amendment Directive (EU) 2015/863 (EU RoHS 3).

SARA-G450 modules are RoHS 3 compliant.

No natural rubbers, hygroscopic materials, or materials containing asbestos are employed.

[Table 24](#) lists the SARA-G450 modules main approvals.

Certification scheme	SARA-G450
GCF (Global Certification Forum)	•
CE (European Conformity)	•
Anatel (Agência Nacional de Telecomunicações Brazil)	•
CCC (Chinese Compulsory Certification)	•
SRRC (State Radio Regulation of China)	•
ICASA (Independent Communications Authority South Africa)	•

Table 24: SARA-G450 main certification approvals

The above listed certifications might not be available for all the different product type numbers. Please contact the u-blox office or sales representative nearest you for the complete list of certification approvals available for the selected product ordering number.

7 Product handling

7.1 Packaging

SARA-G450 modules are delivered as hermetically sealed, reeled tapes to enable efficient production, production lot set-up and tear-down. For more information about packaging, see the u-blox package information guide [\[4\]](#).



Figure 4: Reeled SARA-G450 modules

7.1.1 Reels

SARA-G450 modules are deliverable in quantities of 250 pieces on a reel. SARA-G450 modules are delivered using reel Type B2 as described in the u-blox package information guide [\[4\]](#).

Parameter	Specification
Reel type	B2
Delivery quantity	250

Table 25: Reel information for SARA-G450 modules

 Quantities of less than 250 pieces are also available. Contact u-blox for more information.

7.1.2 Tapes

Figure 5 and Table 26 specify the dimensions of the tapes for SARA-G450 module.

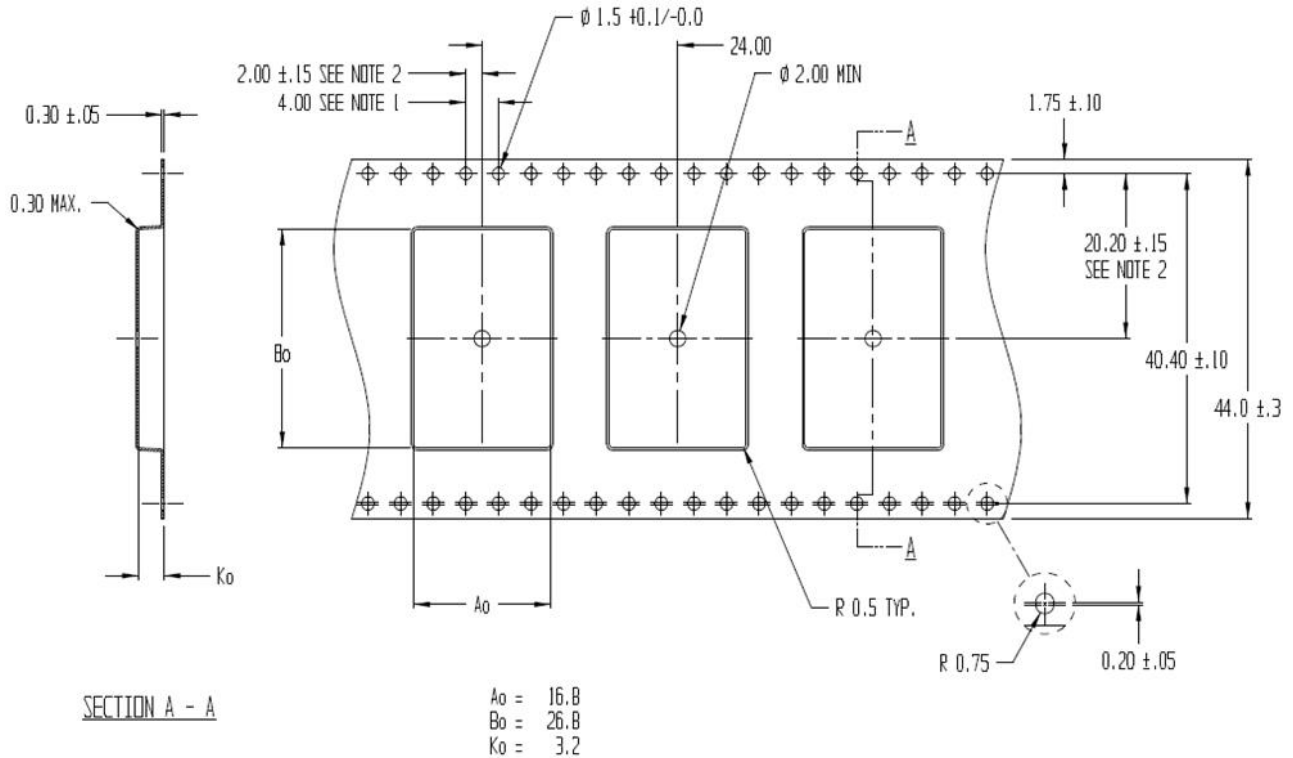

Figure 5: Dimensions for SARA-G450 modules on tape

Parameter	Typical value	Tolerance	Unit
A_0	16.8	± 0.2	mm
B_0	26.8	± 0.2	mm
K_0	3.2	± 0.2	mm

Table 26: SARA-G450 module tape dimensions

- Note 1: 10 sprocket hole pitch cumulative tolerance ± 0.2 mm.
- Note 2: Pocket position relative to sprocket hole measured as true position of pocket, not pocket hole.
- Note 3: A_0 and B_0 are calculated on a plane at a distance “R” above the bottom of the pocket.

7.2 Moisture sensitivity levels

- ⚠ SARA-G450 modules are Moisture Sensitive Devices (MSD) in accordance to the IPC/JEDEC specification.

The Moisture Sensitivity Level (MSL) relates to the packaging and handling precautions required. SARA-G450 modules are rated at MSL level 4. For more information regarding moisture sensitivity levels, labeling, storage and drying see the u-blox package information guide [4].

- 🔗 For MSL standard see IPC/JEDEC J-STD-020 (can be downloaded from www.jedec.org).

7.3 Reflow soldering

Reflow profiles are to be selected according to u-blox recommendations (see SARA-G450 system integration manual [1]).

- ⚠ Failure to observe these precautions can result in severe damage to the device!

7.4 ESD precautions

- ⚠ SARA-G450 modules contain highly sensitive electronic circuitry and are Electrostatic Sensitive Devices (ESD). Handling SARA-G450 modules without proper ESD protection may destroy or damage them permanently.
- ⚠ Ensure ESD precautions are implemented during handling of the module.



SARA-G450 modules are Electrostatic Sensitive Devices (ESD) and require special ESD precautions typically applied to ESD sensitive components.

Table 7 reports the maximum ESD ratings of the SARA-G450 modules.

Proper ESD handling and packaging procedures must be applied throughout the processing, handling and operation of any application that incorporates SARA-G450 modules.

ESD precautions should be implemented on the application board where the module is mounted, as described in the SARA-G450 system integration manual [1].

- ⚠ Failure to observe these precautions can result in severe damage to the device!

8 Default settings

Interface	Settings	Comments
UART interface	AT interface: enabled	AT command interface is by default enabled on the UART physical interface
	AT+IPR=0	One-shot automatic baud rate detection enabled by default
	AT+ICF=3	Frame format 8N1 (8 data bits, no parity, 1 stop bit) enabled by default
	AT&K3	HW flow control enabled
	AT&S1	DSR line set ON in data mode ²¹ and set OFF in command mode ²¹
	AT&D1	Upon an ON-to-OFF transition of DTR, the DCE enters online command mode ²¹ and issues an OK result code
	AT&C1	Circuit 109 changes in accordance with the Carrier detect status; ON if the Carrier is detected, OFF otherwise
	MUX protocol: disabled	Multiplexing mode is by default disabled and it can be configured by +CMUX AT command. The following virtual channels are defined: <ul style="list-style-type: none"> • Channel 0: control channel • Channel 1 – 5: AT commands / data connection • Channel 6: GNSS tunneling²²
AUX UART interface ²²	AT interface: enabled	AT command interface is by default enabled on the AUX UART physical interface, and it can be configured by +USIO AT command (see the u-blox AT commands manual [2])
	AT+IPR=115200	115200 bit/s baud rate enabled by default
	AT+ICF=3	Frame format 8N1 (8 data bits, no parity, 1 stop bit) enabled by default
	AT&K0	None flow control supported
Power Saving	AT+UPSV=0	Disabled
Network registration	AT+COPS=0	Self network registration

Table 27: SARA-G450 module default settings

²¹ For the definition of command mode, data mode, and online command mode, see the u-blox AT commands manual [2].

²² Not supported by “00” product version

9 Labeling and ordering information

9.1 Product labeling

Figure 6 illustrates the label of the SARA-G450 modules, including: u-blox logo, production lot, Pb-free marking, product Type Number, IMEI number, certification info, and production country.

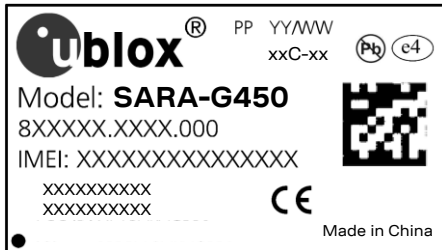

Figure 6: Label of SARA-G450 modules

For information about the approval codes and for all the certificates of SARA-G450 module compliancy, see our website (www.u-blox.com), or please contact the u-blox office or sales representative nearest you.

9.2 Explanation of codes

Three different product code formats are used. The **Product Name** is used in documentation such as this data sheet and identifies all u-blox products, independent of packaging and quality grade. The **Ordering Code** includes options and quality, while the **Type Number** includes the hardware and firmware versions. Table 28 below details these three different formats:

Format	Structure
Product name	PPP(P)-TGVV(D)
Ordering code	PPP(P)-TGVV(D)-TTQ
Type number	PPP(P)-TGVV(D)-TTQ-XX

Table 28: Product code formats

Table 29 explains the parts of the product code.

Code	Meaning	Example
PPP(P)	Form factor	SARA
TG	Platform (technology and generation) <ul style="list-style-type: none"> Dominant technology: G: GSM; U: HSPA; C: CDMA 1xRTT; N: NB-IoT; R: LTE low data rate (Cat 1 and below); L: LTE high data rate (Cat 3 and above) Generation within the technology: 1...9 	G4
VV	Variant based on the same platform: 00...99	50
(D)	Optional LTE category: 6,4,3,1,M ...	
TT	Product version: 00...99	00
Q	Product grade <ul style="list-style-type: none"> A = automotive B = professional C = standard 	C
XX		Default value is 00

Table 29: Part identification code

9.3 Ordering information

Ordering No.	Description
SARA-G450-00C	4-band GSM/GPRS module, Standard grade, 26.0 x 16.0 x 2.4 mm, 250 pcs/reel
SARA-G450-01C	4-band GSM/GPRS module, Standard grade, 26.0 x 16.0 x 2.4 mm, 250 pcs/reel Supporting the same feature-set of the "00" product version plus analog audio, voice calls, jamming detection, smart temperature supervisor, last gasp, second AT interface, I2C for u-blox GNSS receivers, AssistNow, CellLocate®, hybrid positioning

Table 30: Product ordering codes

Appendix

A Glossary

Abbreviation	Definition
2G	2nd Generation cellular technology (GSM, GPRS, EGPRS)
3G	3rd Generation cellular technology (UMTS, HSDPA, HSUPA)
3GPP	3rd Generation Partnership Project
ADC	Analog to Digital Converter
AP	Application Processor
AT	AT command interpreter software subsystem, or ATtention
BER	Bit Error Rate
Cat	Category
CMOS	Complementary Metal-Oxide-Semiconductor
CTS	Clear To Send
DC	Direct Current
DCD	Data Carrier Detect
DCE	Data Communication Equipment
DDC	Display Data Channel (I2C compatible) interface
DL	Down-Link (reception)
DRX	Discontinuous Reception
DSR	Data Set Ready
DTE	Data Terminal Equipment
DTR	Data Terminal Ready
EDGE	Enhanced Data rates for GSM Evolution (EGPRS)
EGPRS	Enhanced General Packet Radio Service (EDGE)
ESD	Electro-Static Discharge
FOAT	Firmware Over AT commands
FTP	File Transfer Protocol
FW	Firmware
GDI	Generic Digital Interfaces (power domain)
GND	Ground
GNSS	Global Navigation Satellite System
GPIO	General Purpose Input/Output
GPRS	General Packet Radio Service
GPS	Global Positioning System
GSM	Global System for Mobile communication
HDLC	High-level Data Link Control
HSPA	High-Speed Packet Access
HTTP	Hyper-Text Transfer Protocol
HW	Hardware
I2C	Inter-Integrated Circuit interface
I2S	Inter-IC Sound interface
IC	Integrated Circuit
IEC	International Electrotechnical Commission
IP	Internet Protocol

Abbreviation	Definition
IPC	Institute of Printed Circuits
ISO	International Organization for Standardization
LGA	Land Grid Array
LPWA	Low Power Wide Area
LTE	Long Term Evolution
M2M	Machine-to-Machine
N/A	Not Applicable
PA	Power Amplifier
PCB	Printed Circuit Board
PCN	Sample Delivery Note / Information Note / Product Change Notification
PD	Pull-Down
PMU	Power Management Unit
POF	Power-Off input signal
PON	Power-On input signal
PU	Pull-Up
RF	Radio Frequency
RI	Ring Indicator
RSVD	Reserved
RTC	Real Time Clock
RTS	Request To Send
Rx	Receiver
SIM	Subscriber Identity Module
SMS	Short Message Service
SPI	Serial Peripheral Interface
T	Tristate (output of the pin set to tri-state, i.e. high impedance state)
T/PD	Tristate with internal active Pull-Down enabled
T/PU	Tristate with internal active Pull-Up enabled
TBD	To Be Defined
TCP	Transmission Control Protocol
TLS	Transport Layer Security
TS	Technical Specification
Tx	Transmitter
UART	Universal Asynchronous Receiver-Transmitter
UDP	User Datagram Protocol
UL	Up-link (transmission)
UMTS	Universal Mobile Telecommunications System
URC	Unsolicited Result Code
USB	Universal Serial Bus interface
VSWR	Voltage Standing Wave Ratio

Table 31: Explanation of the abbreviations and terms used

Related documentation

- [1] u-blox SARA-G450 system integration manual, [UBX-18046432](#)
- [2] u-blox AT commands manual, [UBX-13002752](#)
- [3] u-blox multiplexer implementation application note, [UBX-13001887](#)
- [4] u-blox package information guide, [UBX-14001652](#)
- [5] ITU-T recommendation V24, 02-2000. List of definitions for interchange circuits between Data Terminal Equipment (DTE) and Data Connection Equipment (DCE)
- [6] 3GPP TS 27.007 – Technical Specification Group Core Network and Terminals; AT command set for User Equipment (UE)
- [7] 3GPP TS 27.005 – Technical Specification Group Terminals; Use of Data Terminal Equipment – Data Circuit terminating Equipment (DTE-DCE) interface for Short Message Services (SMS) and Cell Broadcast Service (CBS)
- [8] 3GPP TS 27.010 – Terminal Equipment to User Equipment (TE-UE) multiplexer protocol

 For regular updates to u-blox documentation and to receive product change notifications, register on our homepage (www.u-blox.com).

Revision history

Revision	Date	Name	Status / Comments
R01	22-Jan-2018	sses	Initial release
R02	12-Apr-2018	sses	Updated pin 18 name from RESET_N to PWR_OFF. Updated module power on, power off and reset sections. Added 32 kHz clock output alternative function of GPIO3. Added V_BCKP characteristics.
R03	31-Aug-2018	fvid / sses / lpah	Document rebranded. Added electrical characteristics of UART interfaces, generic digital interfaces, ANT_DET, PWR_ON, PWR_OFF pins and other info. Updated V_INT, digital I/O electrical characteristics Added current consumption figures. Updated Functional description and GPIO sections. Updated SARA-G450-00C product status to prototype.
R04	19-Oct-2018	fvid / sses	Updated SARA-G450-00C product status to Engineering Sample
R05	30-Nov-2018	fvid	Updated SARA-G450-00C product status to Initial Production
R06	05-Jul-2019	lpah	Updated SARA-G450-00C product status to Mass Production Updated generic digital interfaces pins specification and mechanical tolerance
R07	21-Aug-2019	lpah	Extended the document applicability to SARA-G450-00C-01
R08	30-Jan-2020	fvid	Extended the document applicability to SARA-G450-01C-00. Updated extended operating temperature
R09	26-May-2020	fvid	Updated SARA-G450-01C product status to initial production. Updated current consumption figures. Added audio pins electrical specifications.
R10	06-Aug-2020	alos	Updated SARA-G450-00C-01 and SARA-G450-01C-00 application version and PCN reference.
R11	08-Mar-2021	fvid	Updated SARA-G450-01C product status to mass production. Extended the document applicability to SARA-G450-01C-01.

Contact

For complete contact information, visit us at www.u-blox.com.

u-blox Offices

North, Central and South America

u-blox America, Inc.

Phone: +1 703 483 3180
E-mail: info_us@u-blox.com

Regional Office West Coast:

Phone: +1 408 573 3640
E-mail: info_us@u-blox.com

Technical Support:

Phone: +1 703 483 3185
E-mail: support@u-blox.com

Headquarters

Europe, Middle East, Africa

u-blox AG

Phone: +41 44 722 74 44
E-mail: info@u-blox.com
Support: support@u-blox.com

Asia, Australia, Pacific

u-blox Singapore Pte. Ltd.

Phone: +65 6734 3811
E-mail: info_ap@u-blox.com
Support: support_ap@u-blox.com

Regional Office Australia:

Phone: +61 3 9566 7255
E-mail: info_anz@u-blox.com
Support: support_ap@u-blox.com

Regional Office China (Beijing):

Phone: +86 10 68 133 545
E-mail: info_cn@u-blox.com
Support: support_cn@u-blox.com

Regional Office China (Chongqing):

Phone: +86 23 6815 1588
E-mail: info_cn@u-blox.com
Support: support_cn@u-blox.com

Regional Office China (Shanghai):

Phone: +86 21 6090 4832
E-mail: info_cn@u-blox.com
Support: support_cn@u-blox.com

Regional Office China (Shenzhen):

Phone: +86 755 8627 1083
E-mail: info_cn@u-blox.com
Support: support_cn@u-blox.com

Regional Office India:

Phone: +91 80 405 092 00
E-mail: info_in@u-blox.com
Support: support_in@u-blox.com

Regional Office Japan (Osaka):

Phone: +81 6 6941 3660
E-mail: info_jp@u-blox.com
Support: support_jp@u-blox.com

Regional Office Japan (Tokyo):

Phone: +81 3 5775 3850
E-mail: info_jp@u-blox.com
Support: support_jp@u-blox.com

Regional Office Korea:



Phone: +82 2 542 0861
E-mail: info_kr@u-blox.com
Support: support_kr@u-blox.com

Regional Office Taiwan:







Phone: +886 2 2657 1090
E-mail: info_tw@u-blox.com
Support: support_tw@u-blox.com

Looking for pricing, stock, or lifecycle information?

Click below to explore more details on WIN SOURCE:

-  [View SARA-G450-00C-00 on WIN SOURCE](#)
-  [U-blox Information](#)

Optimize Your Supply Chain with WIN SOURCE Solutions

-  Global Sourcing Solution
-  Obsolete Management
-  Cost Control Management
-  Shortage Management
-  Alternative Solution
-  Excess Inventory Management