



**THE DATASHEET OF  
SI7021-A20-IM**



## I<sup>2</sup>C HUMIDITY AND TEMPERATURE SENSOR

### Features

- Precision Relative Humidity Sensor
  - ± 3% RH (max), 0–80% RH
- High Accuracy Temperature Sensor
  - ±0.4 °C (max), –10 to 85 °C
- 0 to 100% RH operating range
- Up to –40 to +125 °C operating range
- Wide operating voltage (1.9 to 3.6 V)
- Low Power Consumption
  - 150 µA active current
  - 60 nA standby current
- Factory-calibrated
- I<sup>2</sup>C Interface
- Integrated on-chip heater
- 3x3 mm DFN Package
- Excellent long term stability
- Optional factory-installed cover
  - Low-profile
  - Protection during reflow
  - Excludes liquids and particulates



### Applications

- HVAC/R
- Thermostats/humidistats
- Respiratory therapy
- White goods
- Indoor weather stations
- Micro-environments/data centers
- Automotive climate control and defogging
- Asset and goods tracking
- Mobile phones and tablets

### Description

The Si7021 I<sup>2</sup>C Humidity and Temperature Sensor is a monolithic CMOS IC integrating humidity and temperature sensor elements, an analog-to-digital converter, signal processing, calibration data, and an I<sup>2</sup>C Interface. The patented use of industry-standard, low-K polymeric dielectrics for sensing humidity enables the construction of low-power, monolithic CMOS Sensor ICs with low drift and hysteresis, and excellent long term stability.

The humidity and temperature sensors are factory-calibrated and the calibration data is stored in the on-chip non-volatile memory. This ensures that the sensors are fully interchangeable, with no recalibration or software changes required.

The Si7021 is available in a 3x3 mm DFN package and is reflow solderable. It can be used as a hardware- and software-compatible drop-in upgrade for existing RH/temperature sensors in 3x3 mm DFN-6 packages, featuring precision sensing over a wider range and lower power consumption. The optional factory-installed cover offers a low profile, convenient means of protecting the sensor during assembly (e.g., reflow soldering) and throughout the life of the product, excluding liquids (hydrophobic/oleophobic) and particulates.

The Si7021 offers an accurate, low-power, factory-calibrated digital solution ideal for measuring humidity, dew-point, and temperature, in applications ranging from HVAC/R and asset tracking to industrial and consumer platforms.

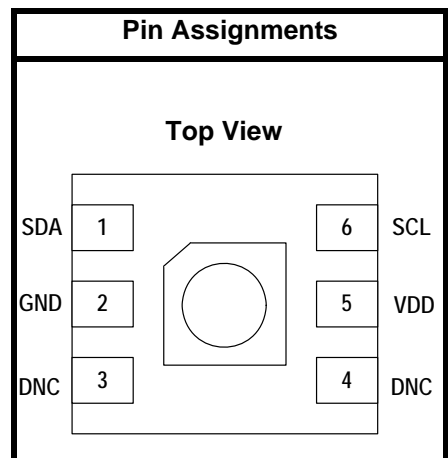

Patent Protected. Patents pending

# Si7021-A20

## Functional Block Diagram

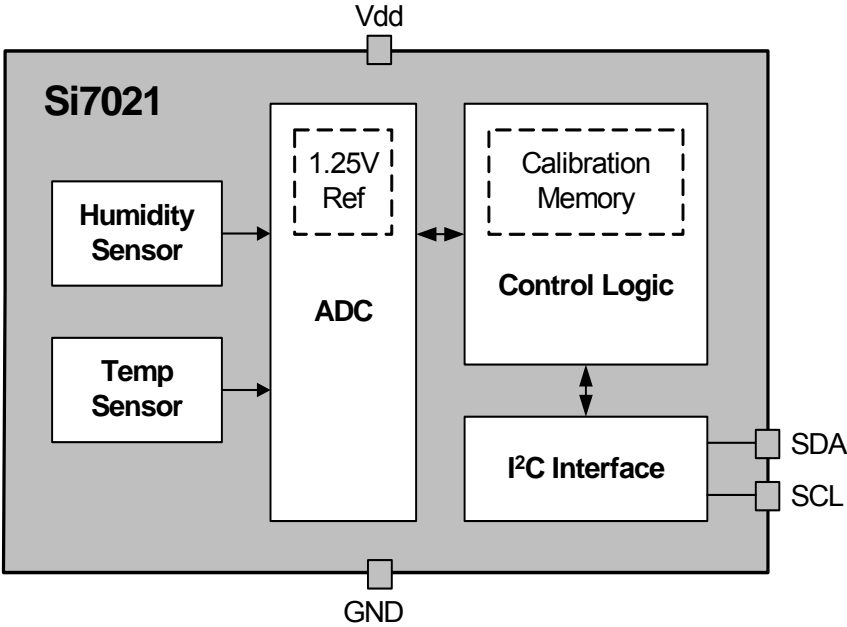

---

**TABLE OF CONTENTS**

---

<b><u>Section</u></b>	<b><u>Page</u></b>
<b>1. Electrical Specifications</b> .....	<b>4</b>
<b>2. Typical Application Circuits</b> .....	<b>11</b>
<b>3. Bill of Materials</b> .....	<b>12</b>
<b>4. Functional Description</b> .....	<b>13</b>
4.1. Relative Humidity Sensor Accuracy .....	14
4.2. Hysteresis .....	15
4.3. Prolonged Exposure to High Humidity .....	15
4.4. PCB Assembly .....	15
4.5. Protecting the Sensor .....	17
4.6. Bake/Hydrate Procedure .....	17
4.7. Long Term Drift/Aging .....	17
<b>5. I2C Interface</b> .....	<b>18</b>
5.1. Issuing a Measurement Command .....	19
5.2. Reading and Writing User Registers .....	23
5.3. Electronic Serial Number .....	23
5.4. Firmware Revision .....	24
5.5. Heater .....	25
<b>6. Control Registers</b> .....	<b>26</b>
6.1. Register Descriptions .....	26
<b>7. Pin Descriptions: Si7021 (Top View)</b> .....	<b>28</b>
<b>8. Ordering Guide</b> .....	<b>29</b>
<b>9. Package Outline</b> .....	<b>30</b>
9.1. Package Outline: 3x3 6-pin DFN .....	30
9.2. Package Outline: 3x3 6-pin DFN with Protective Cover .....	31
<b>10. PCB Land Pattern and Solder Mask Design</b> .....	<b>32</b>
<b>11. Top Marking</b> .....	<b>33</b>
11.1. Si7021 Top Marking .....	33
11.2. Top Marking Explanation .....	33
<b>12. Additional Reference Resources</b> .....	<b>34</b>
<b>Document Change List</b> .....	<b>35</b>

# Si7021-A20

## 1. Electrical Specifications

Unless otherwise specified, all min/max specifications apply over the recommended operating conditions.

**Table 1. Recommended Operating Conditions**

Parameter	Symbol	Test Condition	Min	Typ	Max	Unit
Power Supply	V <sub>DD</sub>		1.9	—	3.6	V
Operating Temperature	T <sub>A</sub>	I and Y grade	-40	—	+125	°C
Operating Temperature	T <sub>A</sub>	G grade	-40	—	+85	°C

**Table 2. General Specifications**

1.9 ≤ V<sub>DD</sub> ≤ 3.6 V; T<sub>A</sub> = -40 to 85 °C (G grade) or -40 to 125 °C (I/Y grade); default conversion time unless otherwise noted.

Parameter	Symbol	Test Condition	Min	Typ	Max	Unit
Input Voltage High	V <sub>IH</sub>	SCL, SDA pins	0.7xV <sub>DD</sub>	—	—	V
Input Voltage Low	V <sub>IL</sub>	SCL, SDA pins	—	—	0.3xV <sub>DD</sub>	V
Input Voltage Range	V <sub>IN</sub>	SCL, SDA pins with respect to GND	0.0	—	V <sub>DD</sub>	V
Input Leakage	I <sub>IL</sub>	SCL, SDA pins	—	—	1	μA
Output Voltage Low	V <sub>OL</sub>	SDA pin; I <sub>OL</sub> = 2.5 mA; V <sub>DD</sub> = 3.3 V	—	—	0.6	V
		SDA pin; I <sub>OL</sub> = 1.2 mA; V <sub>DD</sub> = 1.9 V	—	—	0.4	V
Current Consumption	I <sub>DD</sub>	RH conversion in progress	—	150	180	μA
		Temperature conversion in progress	—	90	120	μA
		Standby, -40 to +85 °C <sup>2</sup>	—	0.06	0.62	μA
		Standby, -40 to +125 °C <sup>2</sup>	—	0.06	3.8	μA
		Peak I <sub>DD</sub> during powerup <sup>3</sup>	—	3.5	4.0	mA
		Peak I <sub>DD</sub> during I <sup>2</sup> C operations <sup>4</sup>	—	3.5	4.0	mA
Heater Current <sup>5</sup>	I <sub>HEAT</sub>		—	3.1 to 94.2	—	mA

**Notes:**

1. Initiating a RH measurement will also automatically initiate a temperature measurement. The total conversion time will be t<sub>CONV</sub>(RH) + t<sub>CONV</sub>(T).
2. No conversion or I<sup>2</sup>C transaction in progress. Typical values measured at 25 °C.
3. Occurs once during powerup. Duration is <5 msec.
4. Occurs during I<sup>2</sup>C commands for Reset, Read/Write User Registers, Read EID, and Read Firmware Version. Duration is <100 μs when I<sup>2</sup>C clock speed is >100 kHz (>200 kHz for 2-byte commands).
5. Additional current consumption when HTRE bit enabled. See Section “5.5. Heater” for more information.

**Table 2. General Specifications (Continued)**

$1.9 \leq V_{DD} \leq 3.6$  V;  $T_A = -40$  to  $85$  °C (G grade) or  $-40$  to  $125$  °C (I/Y grade); default conversion time unless otherwise noted.

Parameter	Symbol	Test Condition	Min	Typ	Max	Unit
Conversion Time <sup>1</sup>	$t_{CONV}$	12-bit RH	—	10	12	ms
		11-bit RH	—	5.8	7	
		10-bit RH	—	3.7	4.5	
		8-bit RH	—	2.6	3.1	
		14-bit temperature	—	7	10.8	
		13-bit temperature	—	4	6.2	
		12-bit temperature	—	2.4	3.8	
		11-bit temperature	—	1.5	2.4	
Powerup Time	$t_{PU}$	From $V_{DD} \geq 1.9$ V to ready for a conversion, 25 °C	—	18	25	ms
		From $V_{DD} \geq 1.9$ V to ready for a conversion, full temperature range	—	—	80	
		After issuing a software reset command	—	5	15	

**Notes:**

1. Initiating a RH measurement will also automatically initiate a temperature measurement. The total conversion time will be  $t_{CONV(RH)} + t_{CONV(T)}$ .
2. No conversion or I<sup>2</sup>C transaction in progress. Typical values measured at 25 °C.
3. Occurs once during powerup. Duration is <5 msec.
4. Occurs during I<sup>2</sup>C commands for Reset, Read/Write User Registers, Read EID, and Read Firmware Version. Duration is <100  $\mu$ s when I<sup>2</sup>C clock speed is >100 kHz (>200 kHz for 2-byte commands).
5. Additional current consumption when HTRE bit enabled. See Section "5.5. Heater" for more information.

**Table 3. I<sup>2</sup>C Interface Specifications<sup>1</sup>**

$1.9 \leq V_{DD} \leq 3.6$  V;  $T_A = -40$  to  $+85$  °C (G grade) or  $-40$  to  $+125$  °C (I/Y grade) unless otherwise noted.

Parameter	Symbol	Test Condition	Min	Typ	Max	Unit
Hysteresis	$V_{HYS}$	High-to-low versus low-to-high transition	$0.05 \times V_{DD}$	—	—	V
SCLK Frequency <sup>2</sup>	$f_{SCL}$		—	—	400	kHz
SCL High Time	$t_{SKH}$		0.6	—	—	$\mu$ s
SCL Low Time	$t_{SKL}$		1.3	—	—	$\mu$ s
Start Hold Time	$t_{STH}$		0.6	—	—	$\mu$ s
Start Setup Time	$t_{STS}$		0.6	—	—	$\mu$ s

**Notes:**

1. All values are referenced to  $V_{IL}$  and/or  $V_{IH}$ .
2. Depending on the conversion command, the Si7021 may hold the master during the conversion (clock stretch). At above 100 kHz SCL, the Si7021 may also hold the master briefly for user register and device ID transactions. At the highest I<sup>2</sup>C speed of 400 kHz the stretching will be <50  $\mu$ s.
3. Pulses up to and including 50 ns will be suppressed.

# Si7021-A20

**Table 3. I<sup>2</sup>C Interface Specifications<sup>1</sup> (Continued)**

1.9 ≤ V<sub>DD</sub> ≤ 3.6 V; T<sub>A</sub> = -40 to +85 °C (G grade) or -40 to +125 °C (I/Y grade) unless otherwise noted.

Parameter	Symbol	Test Condition	Min	Typ	Max	Unit
Stop Setup Time	t <sub>SPS</sub>		0.6	—	—	μs
Bus Free Time	t <sub>BUF</sub>	Between Stop and Start	1.3	—	—	μs
SDA Setup Time	t <sub>DS</sub>		100	—	—	ns
SDA Hold Time	t <sub>DH</sub>		100	—	—	ns
SDA Valid Time	t <sub>VD;DAT</sub>	From SCL low to data valid	—	—	0.9	μs
SDA Acknowledge Valid Time	t <sub>VD;ACK</sub>	From SCL low to data valid	—	—	0.9	μs
Suppressed Pulse Width <sup>3</sup>	t <sub>SPS</sub>		50	—	—	ns

**Notes:**

1. All values are referenced to V<sub>IL</sub> and/or V<sub>IH</sub>.
2. Depending on the conversion command, the Si7021 may hold the master during the conversion (clock stretch). At above 100 kHz SCL, the Si7021 may also hold the master briefly for user register and device ID transactions. At the highest I<sup>2</sup>C speed of 400 kHz the stretching will be <50 μs.
3. Pulses up to and including 50 ns will be suppressed.

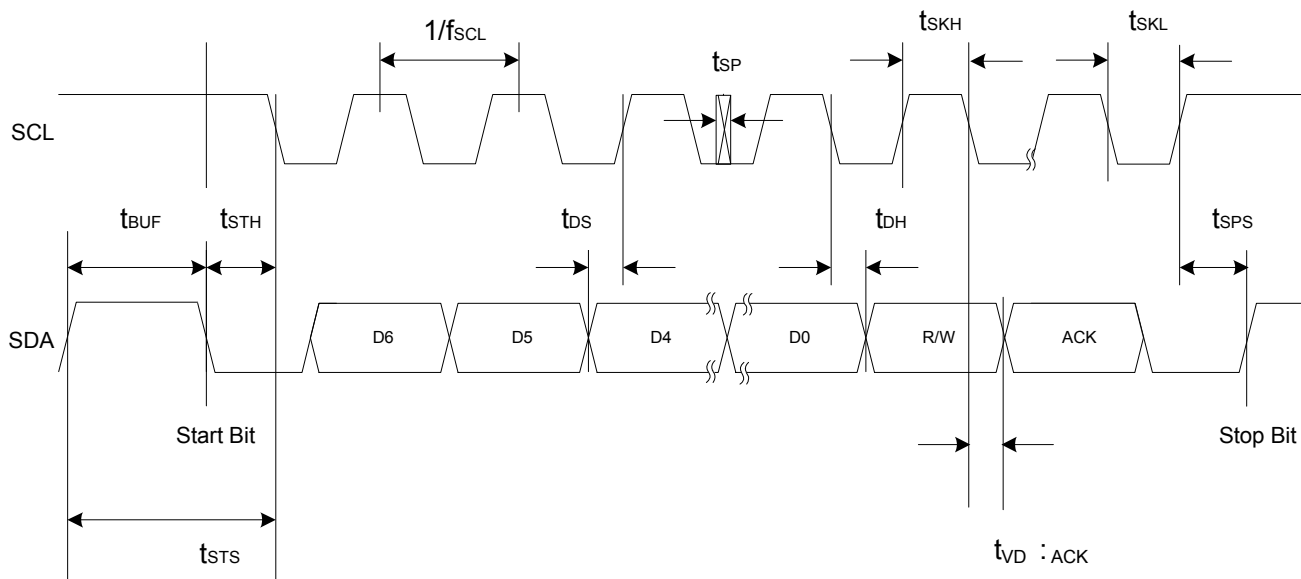

**Figure 1. I<sup>2</sup>C Interface Timing Diagram**

**Table 4. Humidity Sensor**

$1.9 \leq V_{DD} \leq 3.6$  V;  $T_A = 30$  °C; default conversion time unless otherwise noted.

Parameter	Symbol	Test Condition	Min	Typ	Max	Unit
Operating Range <sup>1</sup>		Non-condensing	0	—	100	%RH
Accuracy <sup>2, 3</sup>		0 – 80% RH	—	±2	±3	%RH
		80 – 100% RH	See Figure 2.			
Repeatability/Noise		12-bit resolution	—	0.025	—	%RH RMS
		11-bit resolution	—	0.05	—	
		10-bit resolution	—	0.1	—	
		8-bit resolution	—	0.2	—	
Response Time <sup>4</sup>	$T_{63\%}$	1 m/s airflow, with cover	—	18	—	S
		1 m/s airflow, without cover	—	17	—	
Drift vs. Temperature			—	0.05	—	%RH/°C
Hysteresis			—	±1	—	%RH
Long Term Stability <sup>3</sup>			—	≤ 0.25	—	%RH/yr
<b>Notes:</b>						
1. Recommended humidity operating range is 20% to 80% RH (non-condensing) over –10 °C to 60 °C. Prolonged operation beyond these ranges may result in a shift of sensor reading, with slow recovery time.						
2. Excludes hysteresis, long term drift, and certain other factors and is applicable to non-condensing environments only. See Section “4.1. Relative Humidity Sensor Accuracy” for more details.						
3. Drift due to aging effects at typical room conditions of 30 °C and 30% to 50% RH. May be impacted by dust, vaporized solvents or other contaminants, e.g., out-gassing tapes, adhesives, packaging materials, etc. See Section “4.7. Long Term Drift/Aging” .						
4. Response time to a step change in RH. Time for the RH output to change by 63% of the total RH change.						

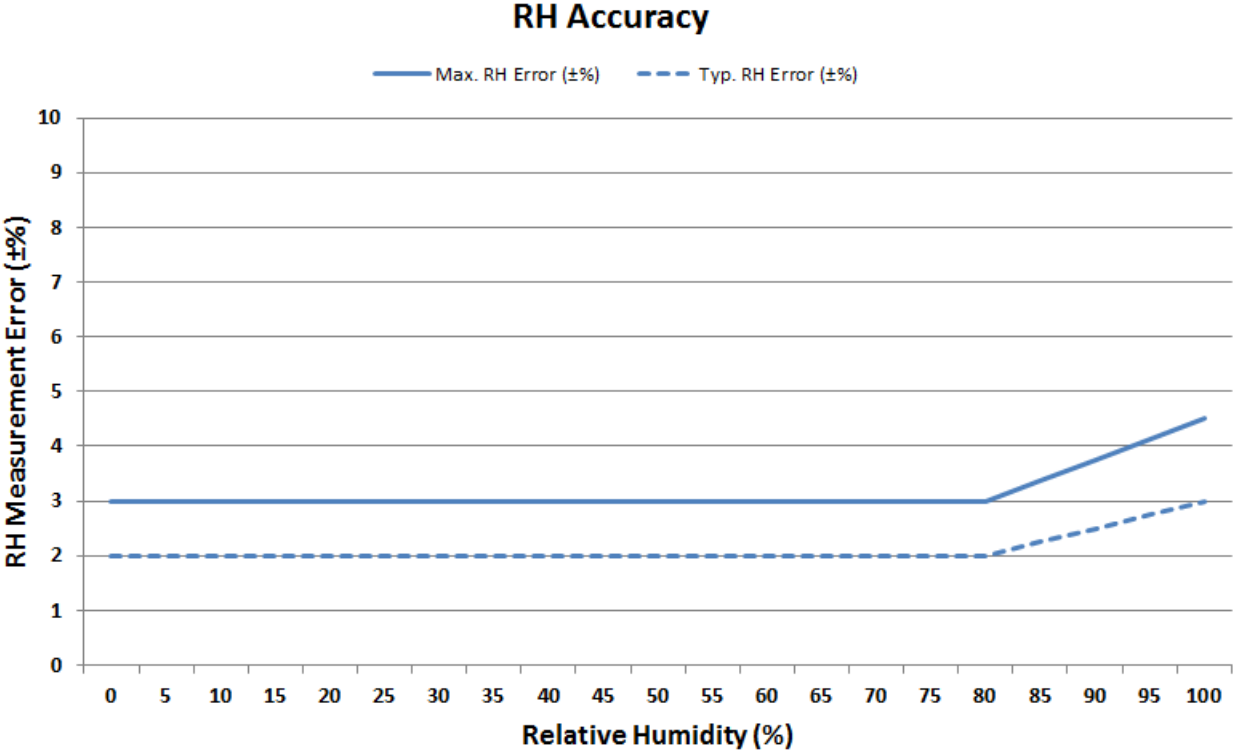

Figure 2. RH Accuracy at 30 °C

**Table 5. Temperature Sensor**

$1.9 \leq V_{DD} \leq 3.6$  V;  $T_A = -40$  to  $+85$  °C (G grade) or  $-40$  to  $+125$  °C (I/Y grade) default conversion time, unless otherwise noted.

Parameter	Symbol	Test Condition	Min	Typ	Max	Unit
Operating Range		I and Y Grade	-40	—	+125	°C
		G Grade	-40	—	+85	°C
Accuracy <sup>1</sup>		$-10 \text{ °C} \leq t_A \leq 85 \text{ °C}$	—	$\pm 0.3$	$\pm 0.4$	°C
		$-40 \leq t_A \leq 125 \text{ °C}$	Figure 3			
Repeatability/Noise		14-bit resolution	—	0.01	—	°C RMS
		13-bit resolution	—	0.02	—	
		12-bit resolution	—	0.04	—	
		11-bit resolution	—	0.08	—	
Response Time <sup>2</sup>	$T_{63\%}$	Unmounted device	—	0.7	—	s
		Si7021-EB board	—	5.1	—	
Long Term Stability			—	$\leq 0.01$	—	°C/Yr

**Notes:**

- 14b measurement resolution (default).
- Time to reach 63% of final value in response to a step change in temperature. Actual response time will vary dependent on system thermal mass and air-flow.

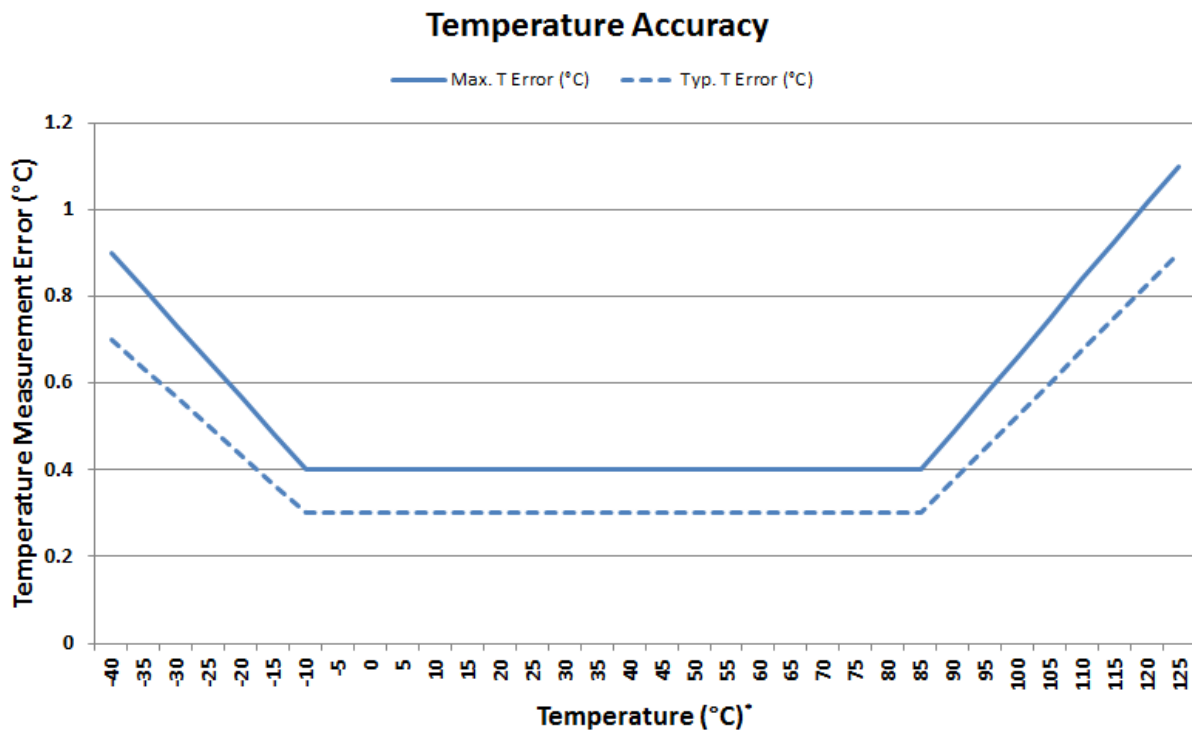
**Figure 3. Temperature Accuracy\***

\*Note: Applies only to I and Y grade devices beyond  $+85$  °C.

# Si7021-A20

**Table 6. Thermal Characteristics**

Parameter	Symbol	Test Condition	DFN-6	Unit
Junction to Air Thermal Resistance	$\theta_{JA}$	JEDEC 2-Layer board, No Airflow	256	°C/W
Junction to Air Thermal Resistance	$\theta_{JA}$	JEDEC 2-Layer board, 1 m/s Airflow	224	°C/W
Junction to Air Thermal Resistance	$\theta_{JA}$	JEDEC 2-Layer board, 2.5 m/s Airflow	205	°C/W
Junction to Case Thermal Resistance	$\theta_{JC}$	JEDEC 2-Layer board	22	°C/W
Junction to Board Thermal Resistance	$\theta_{JB}$	JEDEC 2-Layer board	134	°C/W

**Table 7. Absolute Maximum Ratings<sup>1</sup>**

Parameter	Symbol	Test Condition	Min	Typ	Max	Unit
Ambient temperature under bias			-55	—	125	°C
Storage Temperature <sup>2</sup>			-65	—	150	°C
Voltage on I/O pins			-0.3	—	$V_{DD}+0.3$ V	V
Voltage on VDD with respect to GND			-0.3	—	4.2	V
ESD Tolerance		HBM	—	—	2	kV
		CDM	—	—	1.25	kV
		MM	—	—	250	V

**Notes:**

1. Absolute maximum ratings are stress ratings only, operation at or beyond these conditions is not implied and may shorten the life of the device or alter its performance.
2. Special handling considerations apply; see application note, “AN607: Si70xx Humidity Sensor Designer’s Guide”.

## 2. Typical Application Circuits

The primary function of the Si7021 is to measure relative humidity and temperature. Figure 4 demonstrates the typical application circuit to achieve these functions.

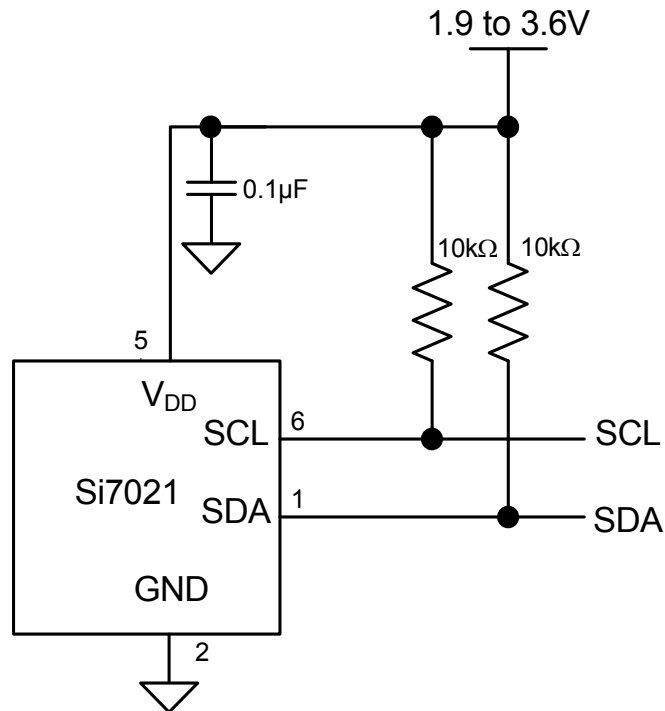

**Figure 4. Typical Application Circuit for Relative Humidity and Temperature Measurement**

# Si7021-A20

---

## 3. Bill of Materials

Table 8. Typical Application Circuit BOM for Relative Humidity and Temperature Measurement

Reference	Description	Mfr Part Number	Manufacturer
R1	Resistor, 10 k $\Omega$ , $\pm$ 5%, 1/16 W, 0603	CR0603-16W-103JT	Venkel
R2	Resistor, 10 k $\Omega$ , $\pm$ 5%, 1/16 W, 0603	CR0603-16W-103JT	Venkel
C1	Capacitor, 0.1 $\mu$ F, 16 V, X7R, 0603	C0603X7R160-104M	Venkel
U1	IC, Digital Temperature/humidity Sensor	Si7021-A20-GM	Silicon Labs

## 4. Functional Description

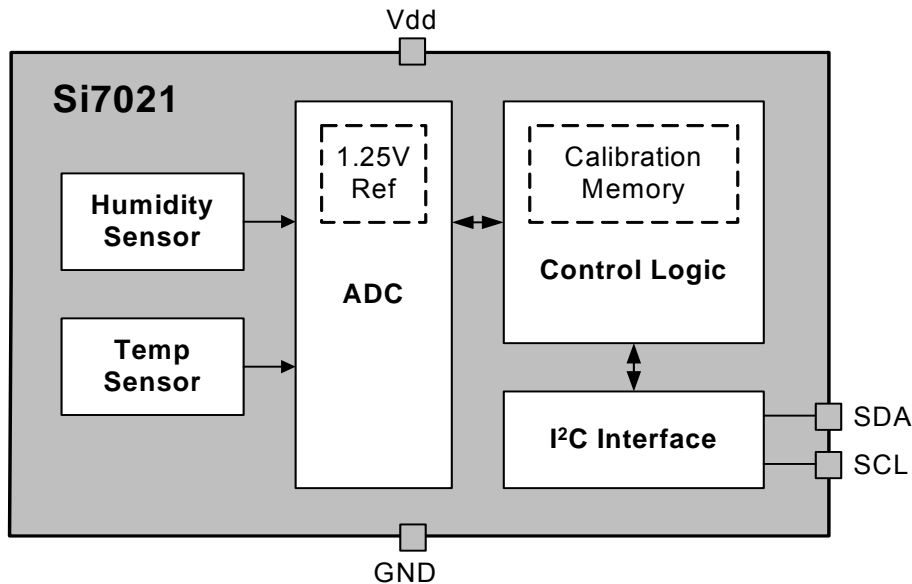

**Figure 5. Si7021 Block Diagram**

The Si7021 is a digital relative humidity and temperature sensor that integrates temperature and humidity sensor elements, an analog-to-digital converter, signal processing, calibration, polynomial non-linearity correction, and an I<sup>2</sup>C interface all in a single chip. The Si7021 is individually factory-calibrated for both temperature and humidity, with the calibration data stored in on-chip non-volatile memory. This ensures that the sensor is fully interchangeable, with no recalibration or changes to software required. Patented use of industry-standard CMOS and low-K dielectrics as a sensor enables the Si7021 to achieve excellent long term stability and immunity to contaminants with low drift and hysteresis. The Si7021 offers a low-power, high-accuracy, calibrated and stable solution ideal for a wide range of temperature, humidity, and dew-point applications including medical and instrumentation, high-reliability automotive and industrial systems, and cost-sensitive consumer electronics.

While the Si7021 is largely a conventional mixed-signal CMOS integrated circuit, relative humidity sensors in general and those based on capacitive sensing using polymeric dielectrics have unique application and use requirements that are not common to conventional (non-sensor) ICs. Chief among those are:

- The need to protect the sensor during board assembly, i.e., solder reflow, and the need to subsequently rehydrate the sensor.
- The need to protect the sensor from damage or contamination during the product life-cycle.
- The impact of prolonged exposure to extremes of temperature and/or humidity and their potential effect on sensor accuracy.
- The effects of humidity sensor “memory”.

Each of these items is discussed in more detail in the following sections.

## 4.1. Relative Humidity Sensor Accuracy

To determine the accuracy of a relative humidity sensor, it is placed in a temperature and humidity controlled chamber. The temperature is set to a convenient fixed value (typically 25–30 °C) and the relative humidity is swept from 20 to 80% and back to 20% in the following steps: 20% – 40% – 60% – 80% – 80% – 60% – 40% – 20%. At each set-point, the chamber is allowed to settle for a period of 60 minutes before a reading is taken from the sensor. Prior to the sweep, the device is allowed to stabilize to 50%RH. The solid trace in Figure 6, “Measuring Sensor Accuracy Including Hysteresis,” shows the result of a typical sweep.

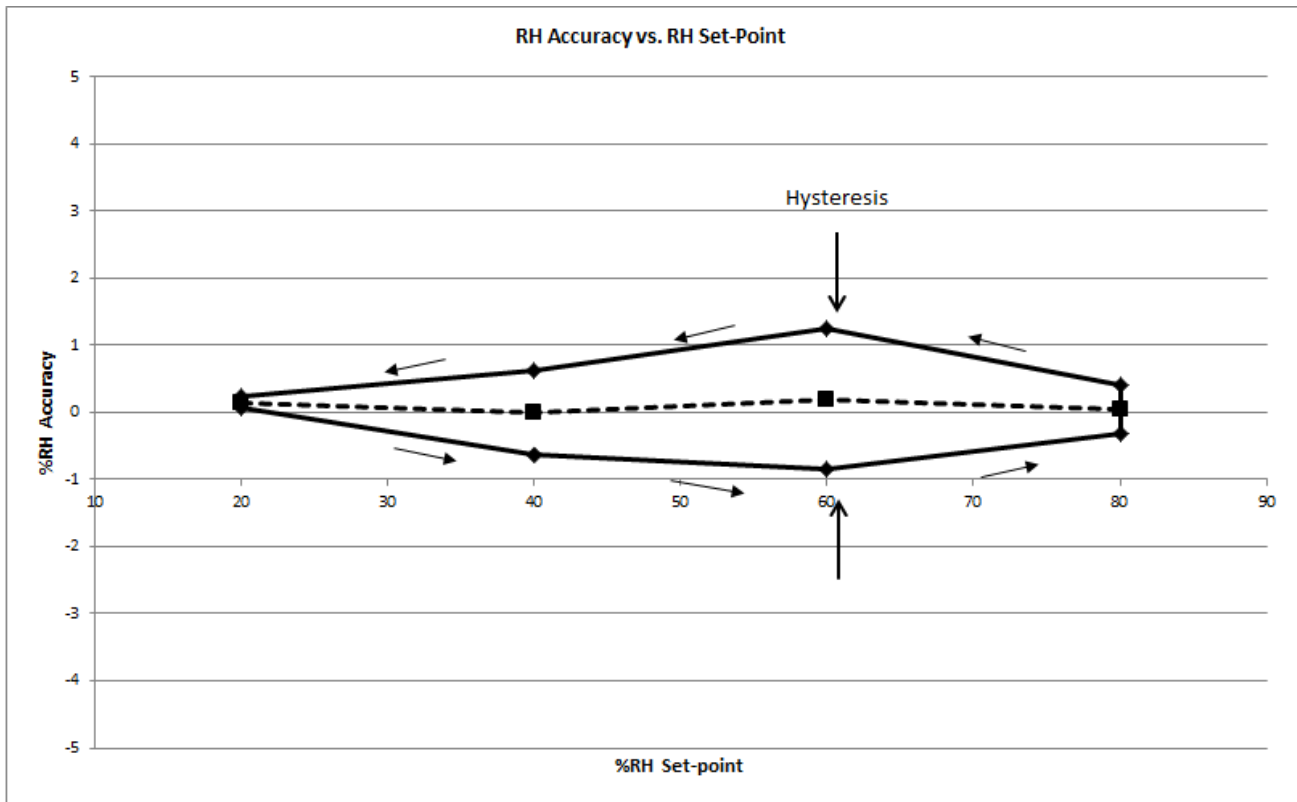

**Figure 6. Measuring Sensor Accuracy Including Hysteresis**

The RH accuracy is defined as the dotted line shown in Figure 6, which is the average of the two data points at each relative humidity set-point. In this case, the sensor shows an accuracy of 0.25%RH. The Si7021 accuracy specification (Table 4) includes:

- Unit-to-unit and lot-to-lot variation
- Accuracy of factory calibration
- Margin for shifts that can occur during solder reflow

The accuracy specification does not include:

- Hysteresis (typically  $\pm 1\%$ )
- Effects from long term exposure to very humid conditions
- Contamination of the sensor by particulates, chemicals, etc.
- Other aging related shifts ("Long-term stability")
- Variations due to temperature (see Drift vs. Temperature in Table 4). RH readings will typically vary with temperature by less than  $\pm 0.05\% \text{ } ^\circ\text{C}$ .

## 4.2. Hysteresis

The moisture absorbent film (polymeric dielectric) of the humidity sensor will carry a memory of its exposure history, particularly its recent or extreme exposure history. A sensor exposed to relatively low humidity will carry a negative offset relative to the factory calibration, and a sensor exposed to relatively high humidity will carry a positive offset relative to the factory calibration. This factor causes a hysteresis effect illustrated by the solid trace in Figure 6. The hysteresis value is the difference in %RH between the maximum absolute error on the decreasing humidity ramp and the maximum absolute error on the increasing humidity ramp at a single relative humidity setpoint and is expressed as a bipolar quantity relative to the average error (dashed trace). In the example of Figure 6, the measurement uncertainty due to the hysteresis effect is  $\pm 1.0\%RH$ .

## 4.3. Prolonged Exposure to High Humidity

Prolonged exposure to high humidity will result in a gradual upward drift of the RH reading. The shift in sensor reading resulting from this drift will generally disappear slowly under normal ambient conditions. The amount of shift is proportional to the magnitude of relative humidity and the length of exposure. In the case of lengthy exposure to high humidity, some of the resulting shift may persist indefinitely under typical conditions. It is generally possible to substantially reverse this affect by baking the device (see Section "4.6. Bake/Hydrate Procedure" ).

## 4.4. PCB Assembly

### 4.4.1. Soldering

Like most ICs, Si7021 devices are shipped from the factory vacuum-packed with an enclosed desiccant to avoid any RH accuracy drift during storage and to prevent any moisture-related issues during solder reflow. The following guidelines should be observed during PCB assembly:

- Si7021 devices are compatible with standard board assembly processes. Devices should be soldered using reflow per the recommended card reflow profile. See Section "10. PCB Land Pattern and Solder Mask Design" for the recommended card reflow profile.
- A "no clean" solder process is recommended to minimize the need for water or solvent rinses after soldering. Cleaning after soldering is possible, but must be done carefully to avoid impacting the performance of the sensor. See "AN607: Si70xx Humidity Sensor Designer's Guide" for more information on cleaning.
- It is essential that the exposed polymer sensing film be kept clean and undamaged. This can be accomplished by careful handling and a clean, well-controlled assembly process. When in doubt or for extra protection, a heat-resistant, protective cover such as Kapton™ KPPD-1/8 polyimide tape can be installed during PCB assembly.

Si7021s may be ordered with a factory-fitted, solder-resistant protective cover. This cover provides protection during PCB assembly or rework but without the time and effort required to install and remove the Kapton tape. It can be left in place for the lifetime of the product, preventing liquids, dust or other contaminants from coming into contact with the polymer sensor film. See Section "8. Ordering Guide" for a list of ordering part numbers that include the cover.

# Si7021-A20

---

## 4.4.2. Rehydration

The measured humidity value will generally shift slightly after solder reflow. A portion of this shift is permanent and is accounted for in the accuracy specifications in Table 4. After soldering, an Si7021 should be allowed to equilibrate under controlled RH conditions (room temperature, 45–55%RH) for at least 48 hours to eliminate the remainder of the shift and return the device to its specified accuracy performance.

## 4.4.3. Rework

To maintain the specified sensor performance, care must be taken during rework to minimize the exposure of the device to excessive heat and to avoid damage/contamination or a shift in the sensor reading due to liquids, solder flux, etc. Manual touch-up using a soldering iron is permissible under the following guidelines:

- The exposed polymer sensing film must be kept clean and undamaged. A protective cover is recommended during any rework operation (Kapton® tape or the factory installed cover).
- Flux must not be allowed to contaminate the sensor; liquid flux is not recommended even with a cover in place. Conventional lead-free solder with rosin core is acceptable for touch-up as long as a cover is in place during the rework.
- If possible, avoid water or solvent rinses after touch-up. Cleaning after soldering is possible, but must be done carefully to avoid impacting the performance of the sensor. See AN607 for more information on cleaning.
- Minimize the heating of the device. Soldering iron temperatures should not exceed 350 °C and the contact time per pin should not exceed five seconds.
- Hot air rework is not recommended. If a device must be replaced, remove the device by hot air and solder a new part in its place by reflow following the guidelines above.

**\*Note:** All trademarks are the property of their respective owners.



**Figure 7. Si7021 with Factory-Installed Protective Cover**

#### 4.5. Protecting the Sensor

Because the sensor operates on the principal of measuring a change in capacitance, any changes to the dielectric constant of the polymer film will be detected as a change in relative humidity. Therefore, it is important to minimize the probability of contaminants coming into contact with the sensor. Dust and other particles as well as liquids can affect the RH reading. It is recommended that a cover is employed in the end system that blocks contaminants but allows water vapor to pass through. Depending on the needs of the application, this can be as simple as plastic or metallic gauze for basic protection against particulates or something more sophisticated such as a hydrophobic membrane providing up to IP67 compliant protection.

The Si7021 may be ordered with a factory-fitted, solder-resistant cover that can be left in place for the lifetime of the product. It is very low-profile, hydrophobic and oleophobic. See Section “8. Ordering Guide” for a list of ordering part numbers that include the cover. A dimensioned drawing of the IC with the cover is included in Section “9. Package Outline” . Other characteristics of the cover are listed in Table 9.

**Table 9. Specifications of Protective Cover**

Parameter	Value
Material	PTFE
Operating Temperature	-40 to 125 °C
Maximum Reflow Temperature	260 °C
IP Rating (per IEC 529)	IP67

#### 4.6. Bake/Hydrate Procedure

After exposure to extremes of temperature and/or humidity for prolonged periods, the polymer sensor film can become either very dry or very wet, in each case the result is either high or low relative humidity readings. Under normal operating conditions, the induced error will diminish over time. From a very dry condition, such as after shipment and soldering, the error will diminish over a few days at typical controlled ambient conditions, e.g., 48 hours of  $45 \leq \%RH \leq 55$ . However, from a very wet condition, recovery may take significantly longer. To accelerate recovery from a wet condition, a bake and hydrate cycle can be implemented. This operation consists of the following steps:

- Baking the sensor at 125 °C for  $\geq 12$  hours
- Hydration at 30 °C in 75% RH for  $\geq 10$  hours

Following this cycle, the sensor will return to normal operation in typical ambient conditions after a few days.

#### 4.7. Long Term Drift/Aging

Over long periods of time, the sensor readings may drift due to aging of the device. Standard accelerated life testing of the Si7021 has resulted in the specifications for long-term drift shown in Table 4 and Table 5. This contribution to the overall sensor accuracy accounts only for the long-term aging of the device in an otherwise benign operating environment and does not include the effects of damage, contamination, or exposure to extreme environmental conditions.

## 5. I<sup>2</sup>C Interface

The Si7021 communicates with the host controller over a digital I<sup>2</sup>C interface. The 7-bit base slave address is 0x40.

**Table 10. I<sup>2</sup>C Slave Address Byte**

A6	A5	A4	A3	A2	A1	A0	R/W
1	0	0	0	0	0	0	0

Master I<sup>2</sup>C devices communicate with the Si7021 using a command structure. The commands are listed in the I<sup>2</sup>C command table. Commands other than those documented below are undefined and should not be sent to the device.

**Table 11. I<sup>2</sup>C Command Table**

Command Description	Command Code
Measure Relative Humidity, Hold Master Mode	0xE5
Measure Relative Humidity, No Hold Master Mode	0xF5
Measure Temperature, Hold Master Mode	0xE3
Measure Temperature, No Hold Master Mode	0xF3
Read Temperature Value from Previous RH Measurement	0xE0
Reset	0xFE
Write RH/T User Register 1	0xE6
Read RH/T User Register 1	0xE7
Write Heater Control Register	0x51
Read Heater Control Register	0x11
Read Electronic ID 1st Byte	0xFA 0x0F
Read Electronic ID 2nd Byte	0xFC 0xC9
Read Firmware Revision	0x84 0xB8

## 5.1. Issuing a Measurement Command

The measurement commands instruct the Si7021 to perform one of two possible measurements; Relative Humidity or Temperature. The procedure to issue any one of these commands is identical. While the measurement is in progress, the option of either clock stretching (Hold Master Mode) or Not Acknowledging read requests (No Hold Master Mode) is available to indicate to the master that the measurement is in progress; the chosen command code determines which mode is used.

Optionally, a checksum byte can be returned from the slave for use in checking for transmission errors. The checksum byte will follow the least significant measurement byte if it is acknowledged by the master. The checksum byte is not returned if the master “not acknowledges” the least significant measurement byte. The checksum byte is calculated using a CRC generator polynomial of  $x^8 + x^5 + x^4 + 1$ , with an initialization of 0x00.

The checksum byte is optional after initiating an RH or temperature measurement with commands 0xE5, 0xF5, 0xE3, and 0xF3. The checksum byte is required for reading the electronic ID with commands 0xFA 0x0F and 0xFC 0xC9. For all other commands, the checksum byte is not supported.

**Table 12. I<sup>2</sup>C Bit Descriptions**

Name	Symbol	Description
START	S	SDA goes low while SCL high.
STOP	P	SDA goes high while SCL high.
Repeated START	Sr	SDA goes low while SCL high. It is allowable to generate a STOP before the repeated start. SDA can transition to high before or after SCL goes high in preparation for generating the START.
READ	R	Read bit = 1
WRITE	W	Write bit = 0
All other bits	—	SDA value must remain high or low during the entire time SCL is high (this is the set up and hold time in Figure 1).

In the I<sup>2</sup>C sequence diagrams in the following sections, bits produced by the master and slave are color coded as shown:



## Sequence to perform a measurement and read back result (Hold Master Mode)

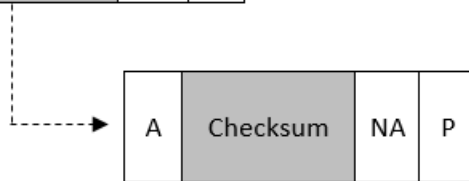
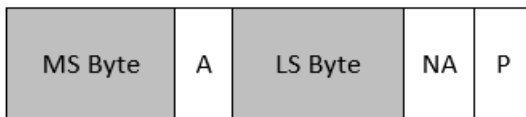
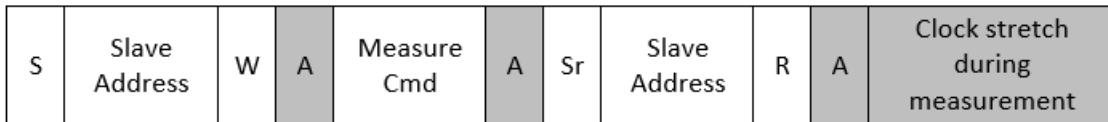

## Sequence to perform a measurement and read back result (No Hold Master Mode)

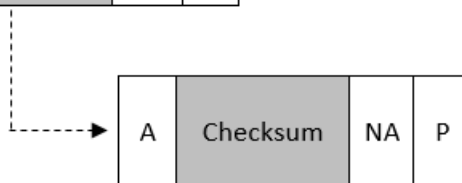
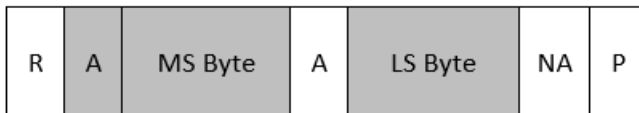
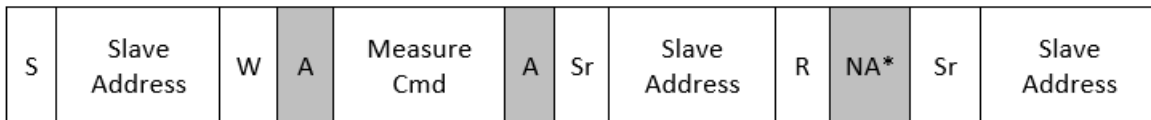

**\*Note:** Device will NACK the slave address byte until conversion is complete.

### 5.1.1. Measuring Relative Humidity

Once a relative humidity measurement has been made, the results of the measurement may be converted to percent relative humidity by using the following expression:

$$\%RH = \frac{125 * RH\_Code}{65536} - 6$$

Where:

%RH is the measured relative humidity value in %RH

RH\_Code is the 16-bit word returned by the Si7021

A humidity measurement will always return XXXXXX10 in the LSB field.

Due to normal variations in RH accuracy of the device as described in Table 4, it is possible for the measured value of %RH to be slightly less than 0 when the actual RH level is close to or equal to 0. Similarly, the measured value of %RH may be slightly greater than 100 when the actual RH level is close to or equal to 100. This is expected behavior, and it is acceptable to limit the range of RH results to 0 to 100%RH in the host software by truncating values that are slightly outside of this range.

### 5.1.2. Measuring Temperature

Each time a relative humidity measurement is made a temperature measurement is also made for the purposes of temperature compensation of the relative humidity measurement. If the temperature value is required, it can be read using command 0xE0; this avoids having to perform a second temperature measurement. The measure temperature commands 0xE3 and 0xF3 will perform a temperature measurement and return the measurement value, command 0xE0 does not perform a measurement but returns the temperature value measured during the relative humidity measurement.

The checksum output is not available with the 0xE0 command.

#### Sequence to read temperature value from previous RH measurement

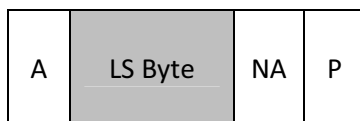
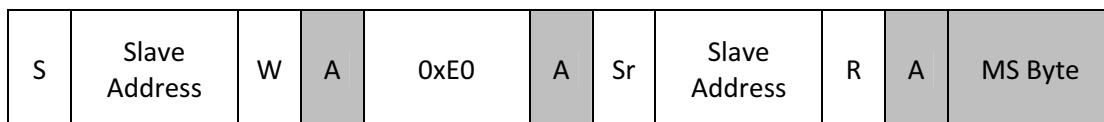

# Si7021-A20

---

The results of the temperature measurement may be converted to temperature in degrees Celsius (°C) using the following expression:

$$\text{Temperature (}^{\circ}\text{C)} = \frac{175.72 * \text{Temp\_Code}}{65536} - 46.85$$

Where:

Temperature (°C) is the measured temperature value in °C

Temp\_Code is the 16-bit word returned by the Si7021

A temperature measurement will always return XXXXXX00 in the LSB field.

## 5.2. Reading and Writing User Registers

There is one user register on the Si7021 that allows the user to set the configuration of the Si7021. The procedure for accessing that register is described below.

The checksum byte is not supported after reading a user register.

Sequence to read a register

S	Slave Address	W	A	Read Reg Cmd	A	Sr	Slave Address	R	A	Read Data	NA	P
---	---------------	---	---	--------------	---	----	---------------	---	---	-----------	----	---

Sequence to write a register

S	Slave Address	W	A	Write Reg Cmd	A	Write Data	A	P
---	---------------	---	---	---------------	---	------------	---	---

## 5.3. Electronic Serial Number

The Si7021 provides a serial number individualized for each device that can be read via the I<sup>2</sup>C serial interface.

Two I<sup>2</sup>C commands are required to access the device memory and retrieve the complete serial number. The command sequence, and format of the serial number response is described in the figure below:



First access:

S	Slave Address	W	ACK	0xFA	ACK	0X0F	ACK		
S	Slave Address	R	ACK						
	SNA_3	ACK	CRC	ACK	SNA_2	ACK	CRC	ACK	
	SNA_1	ACK	CRC	ACK	SNA_0	ACK	CRC	NACK	P

2nd access:

S	Slave Address	W	ACK	0xFC	ACK	0XC9	ACK		
S	Slave Address	R	ACK						
	SNB_3	ACK	SNB_2	ACK	CRC	ACK			
	SNB_1	ACK	SNB_0	ACK	CRC	NACK	P		

# Si7021-A20

---

The format of the complete serial number is 64-bits in length, divided into 8 data bytes. The complete serial number sequence is shown below:

SNA_3	SNA_2	SNA_1	SNA_0	SNB_3	SNB_2	SNB_1	SNB_0
-------	-------	-------	-------	-------	-------	-------	-------

The SNB3 field contains the device identification to distinguish between the different Silicon Labs relative humidity and temperature devices. The value of this field maps to the following devices according to this table:

0x00 or 0xFF engineering samples

0x0D=13=Si7013

0x14=20=Si7020

0x15=21=Si7021

## 5.4. Firmware Revision

The internal firmware revision can be read with the following I<sup>2</sup>C transaction:

S	Slave Address	W	A	0x84	A	0xB8	A	S	Slave Address
---	---------------	---	---	------	---	------	---	---	---------------

R	A	FWREV	NA	P
---	---	-------	----	---

The values in this field are encoded as follows:

0xFF = Firmware version 1.0

0x20 = Firmware version 2.0

## 5.5. Heater

The Si7021 contains an integrated resistive heating element that may be used to raise the temperature of the sensor. This element can be used to test the sensor, to drive off condensation, or to implement dew-point measurement when the Si7021 is used in conjunction with a separate temperature sensor such as another Si7021 (the heater will raise the temperature of the internal temperature sensor).

The heater can be activated using HTRE, bit 2 in User Register 1. Turning on the heater will reduce the tendency of the humidity sensor to accumulate an offset due to "memory" of sustained high humidity conditions. Several different power levels are available. The various settings are adjusted using the Heater Control Register and are described in the following table.

**Table 13. Heater Control Settings**

HEATER[3:0]	Typical Current Draw* (mA)
0000	3.09
0001	9.18
0010	15.24
...	...
0100	27.39
...	...
1000	51.69
...	...
1111	94.20
<b>*Note:</b> Assumes $V_{DD} = 3.3$ V.	

## 6. Control Registers

**Table 14. Register Summary**

Register	Bit 7	Bit 6	Bit 5	Bit 4	Bit 3	Bit 2	Bit 1	Bit 0
User Register 1	RES1	VDDS	RSVD	RSVD	RSVD	HTRE	RSVD	RES0
Heater Control Register	RSVD				HEATER[3:0]			

**Notes:**

1. Any register not listed here is reserved and must not be written. The result of a read operation on these bits is undefined.
2. Except where noted, reserved register bits will always read back as “1,” and are not affected by write operations. For future compatibility, it is recommended that prior to a write operation, registers should be read. Then the values read from the RSVD bits should be written back unchanged during the write operation.

### 6.1. Register Descriptions

#### Register 1. User Register 1

Bit	D7	D6	D5	D4	D3	D2	D1	D0
<b>Name</b>	RES1	VDDS	RSVD	RSVD	RSVD	HTRE	RSVD	RES0
<b>Type</b>	R/W	R	R/W	R/W		R/W	R/W	R/W

Reset Settings = 0011\_1010

Bit	Name	Function															
D7; D0	RES[1:0]	Measurement Resolution: <table style="margin-left: 20px;"> <tr> <td></td> <td>RH</td> <td>Temp</td> </tr> <tr> <td>00:</td> <td>12 bit</td> <td>14 bit</td> </tr> <tr> <td>01:</td> <td>8 bit</td> <td>12 bit</td> </tr> <tr> <td>10:</td> <td>10 bit</td> <td>13 bit</td> </tr> <tr> <td>11:</td> <td>11 bit</td> <td>11 bit</td> </tr> </table>		RH	Temp	00:	12 bit	14 bit	01:	8 bit	12 bit	10:	10 bit	13 bit	11:	11 bit	11 bit
	RH	Temp															
00:	12 bit	14 bit															
01:	8 bit	12 bit															
10:	10 bit	13 bit															
11:	11 bit	11 bit															
D6	VDDS	V <sub>DD</sub> Status: <table style="margin-left: 20px;"> <tr> <td>0:</td> <td>V<sub>DD</sub> OK</td> </tr> <tr> <td>1:</td> <td>V<sub>DD</sub> Low</td> </tr> </table> <p>The minimum recommended operating voltage is 1.9 V. A transition of the V<sub>DD</sub> status bit from 0 to 1 indicates that V<sub>DD</sub> is between 1.8 V and 1.9 V. If the V<sub>DD</sub> drops below 1.8 V, the device will no longer operate correctly.</p>	0:	V <sub>DD</sub> OK	1:	V <sub>DD</sub> Low											
0:	V <sub>DD</sub> OK																
1:	V <sub>DD</sub> Low																
D5, D4, D3	RSVD	Reserved															
D2	HTRE	1 = On-chip Heater Enable 0 = On-chip Heater Disable															
D1	RSVD	Reserved															

**Register 2. Heater Control Register**

Bit	D7	D6	D5	D4	D3	D2	D1	D0
Name	RSVD				Heater [3:0]			
Type	R/W				R/W			

Reset Settings = 0000\_0000

Bit	Name	Function				
D3:D0	HEATER[3:0]	D3	D2	D1	D0	Heater Current
		0	0	0	0	3.09 mA
		0	0	0	1	9.18 mA
		0	0	1	0	15.24 mA
				...		
		0	1	0	0	27.39 mA
				...		
		1	0	0	0	51.69 mA
				...		
		1	1	1	1	94.20 mA
D7,D6, D5,D4	RSVD	Reserved				

# Si7021-A20

## 7. Pin Descriptions: Si7021 (Top View)

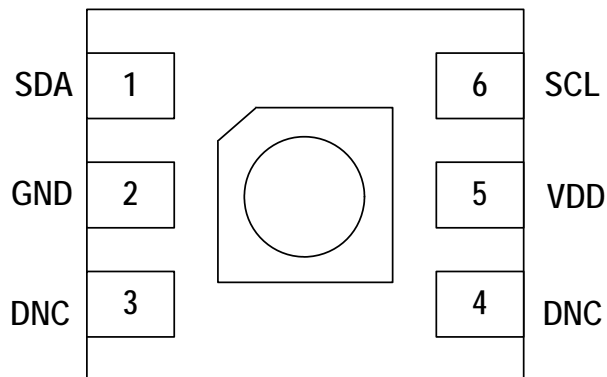

Pin Name	Pin #	Pin Description
SDA	1	I <sup>2</sup> C data
GND	2	Ground. This pin is connected to ground on the circuit board through a trace. Do not connect directly to GND plane.
VDD	5	Power. This pin is connected to power on the circuit board.
SCL	6	I <sup>2</sup> C clock
DNC	3,4	These pins should be soldered to pads on the PCB for mechanical stability; they can be electrically floating or tied to V <sub>DD</sub> (do not tie to GND).
T <sub>GND</sub>	Paddle	This pad is connected to GND internally. This pad is the main thermal input to the on-chip temperature sensor. The paddle should be soldered to a floating pad.

## 8. Ordering Guide

**Table 15. Device Ordering Guide**

P/N	Description	Max. Accuracy		Pkg	Operating Range (°C)	Protective Cover	Packing Format
		Temp	RH				
Si7021-A20-GM	Digital temperature/ humidity sensor	±0.4 °C	± 3%	DFN 6	-40 to +85 °C	N	Cut Tape
Si7021-A20-GMR	Digital temperature/ humidity sensor	±0.4 °C	± 3%	DFN 6	-40 to +85 °C	N	Tape & Reel
Si7021-A20-GM1	Digital temperature/ humidity sensor	±0.4 °C	± 3%	DFN 6	-40 to +85 °C	Y	Cut Tape
Si7021-A20-GM1R	Digital temperature/ humidity sensor	±0.4 °C	± 3%	DFN 6	-40 to +85 °C	Y	Tape & Reel
Si7021-A20-IM	Digital temperature/ humidity sensor – industrial temp range	±0.4 °C	± 3%	DFN 6	-40 to +125 °C	N	Cut Tape
Si7021-A20-IMR	Digital temperature/ humidity sensor – industrial temp range	±0.4 °C	± 3%	DFN 6	-40 to +125 °C	N	Tape & Reel
Si7021-A20-IM1	Digital temperature/ humidity sensor – industrial temp range	±0.4 °C	± 3%	DFN 6	-40 to +125 °C	Y	Cut Tape
Si7021-A20-IM1R	Digital temperature/ humidity sensor – industrial temp range	±0.4 °C	± 3%	DFN 6	-40 to +125 °C	Y	Tape & Reel
Si7021-A20-YM0	Digital temperature/ humidity sensor – automotive	±0.4 °C	± 3%	DFN 6	-40 to +125 °C	N	Cut Tape
Si7021-A20-YM0R	Digital temperature/ humidity sensor – automotive	±0.4 °C	± 3%	DFN 6	-40 to +125 °C	N	Tape & Reel
Si7021-A20-YM1	Digital temperature/ humidity sensor – automotive	±0.4 °C	± 3%	DFN 6	-40 to +125 °C	Y	Cut Tape
Si7021-A20-YM1R	Digital temperature/ humidity sensor – automotive	±0.4 °C	± 3%	DFN 6	-40 to +125 °C	Y	Tape & Reel

**Note:** The “A” denotes product revision A and “20” denotes firmware version 2.0.

## 9. Package Outline

### 9.1. Package Outline: 3x3 6-pin DFN

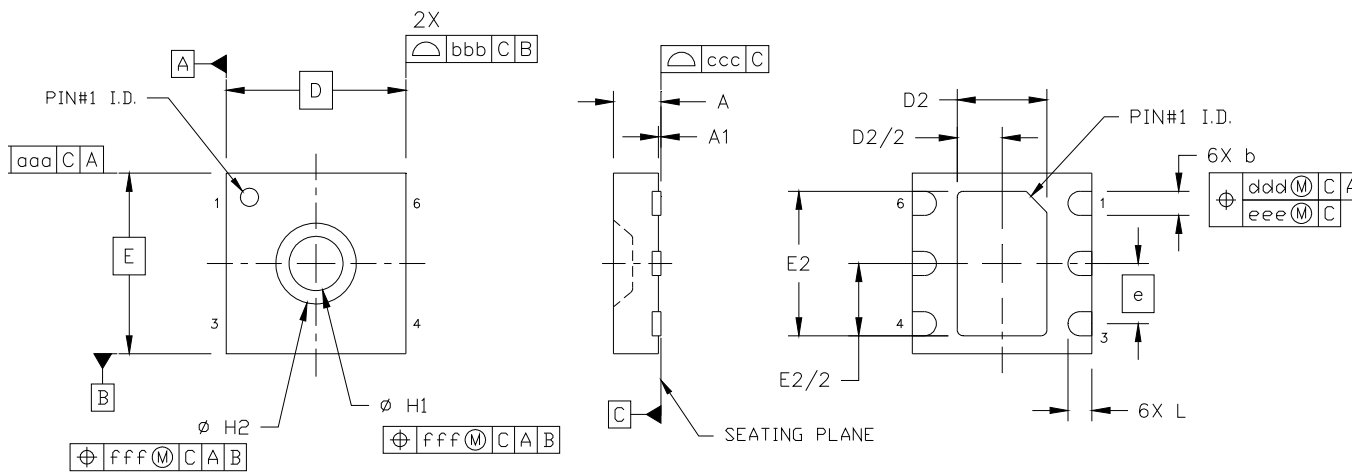

Figure 10. 3x3 6-pin DFN

Table 16. 3x3 6-pin DFN Package Diagram Dimensions

Dimension	Min	Nom	Max
A	0.70	0.75	0.80
A1	0.00	0.02	0.05
b	0.35	0.40	0.45
D	3.00 BSC.		
D2	1.40	1.50	1.60
e	1.00 BSC.		
E	3.00 BSC.		
E2	2.30	2.40	2.50
H1	0.85	0.90	0.95
H2	1.39	1.44	1.49
L	0.35	0.40	0.45
aaa	0.10		
bbb	0.10		
ccc	0.05		
ddd	0.10		
eee	0.05		
fff	0.05		
<b>Notes:</b>			
1. All dimensions shown are in millimeters (mm).			
2. Dimensioning and Tolerancing per ANSI Y14.5M-1994.			

## 9.2. Package Outline: 3x3 6-pin DFN with Protective Cover

Figure 8 illustrates the package details for the Si7021 with the optional protective cover. The table below lists the values for the dimensions shown in the illustration.

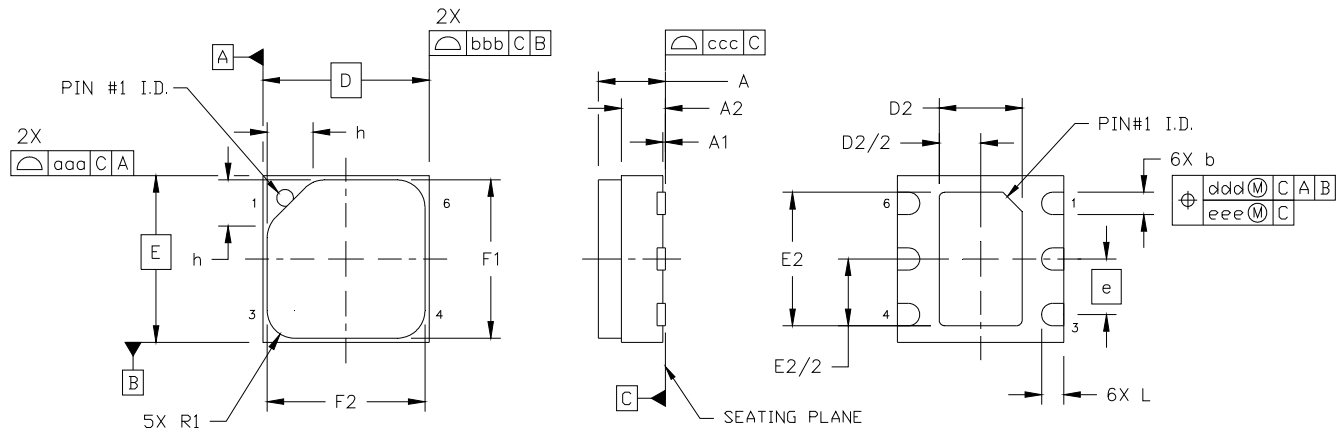

**Figure 8. 3x3 6-pin DFN with Protective Cover**

**Table 17. 3x3 6-pin DFN with Protective Cover Package Diagram Dimensions**

Dimension	Min	Nom	Max
A	—	—	1.21
A1	0.00	0.02	0.05
A2	0.70	0.75	0.80
b	0.35	0.40	0.45
D	3.00 BSC.		
D2	1.40	1.50	1.60
e	1.00 BSC.		
E	3.00 BSC.		
E2	2.30	2.40	2.50
F1	2.70	2.80	2.90
F2	2.70	2.80	2.90
h	0.76	0.83	0.90
L	0.35	0.40	0.45
R1	0.45	0.50	0.55
aaa	0.10		
bbb	0.10		
ccc	0.05		
ddd	0.10		
eee	0.05		
<b>Notes:</b>			
1. All dimensions are shown in millimeters (mm).			
2. Dimensioning and Tolerancing per ANSI Y14.5M-1994.			

## 10. PCB Land Pattern and Solder Mask Design

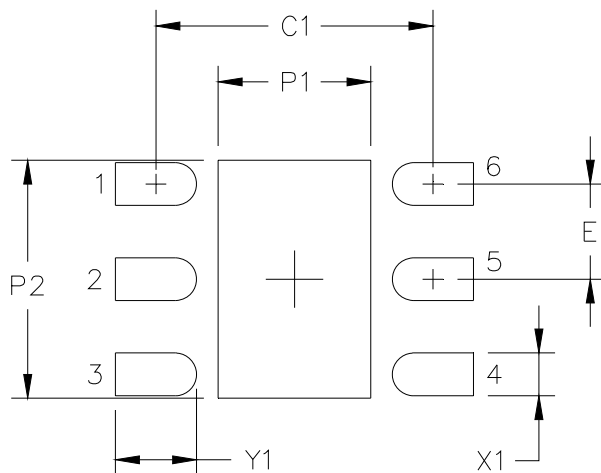

Figure 9. Si7021 PCB Land Pattern

Table 18. PCB Land Pattern Dimensions

Symbol	mm
C1	2.90
E	1.00
P1	1.60
P2	2.50
X1	0.45
Y1	0.85

**Notes:**

**General**

1. All dimensions shown are at Maximum Material Condition (MMC). Least Material Condition (LMC) is calculated based on a Fabrication Allowance of 0.05 mm.
2. This Land Pattern Design is based on the IPC-7351 guidelines.

**Solder Mask Design**

3. All metal pads are to be non-solder mask defined (NSMD). Clearance between the solder mask and the metal pad is to be 60  $\mu\text{m}$  minimum, all the way around the pad.

**Stencil Design**

4. A stainless steel, laser-cut and electro-polished stencil with trapezoidal walls should be used to assure good solder paste release.
5. The stencil thickness should be 0.125 mm (5 mils).
6. The ratio of stencil aperture to land pad size should be 1:1 for all perimeter pins.
7. A 2x1 array of 1.00 mm square openings on 1.30 mm pitch should be used for the center ground pad to achieve a target solder coverage of 50%.

**Card Assembly**

8. The recommended card reflow profile is per the JEDEC/IPC J-STD-020 specification for Small Body Components.

## 11. Top Marking

### 11.1. Si7021 Top Marking

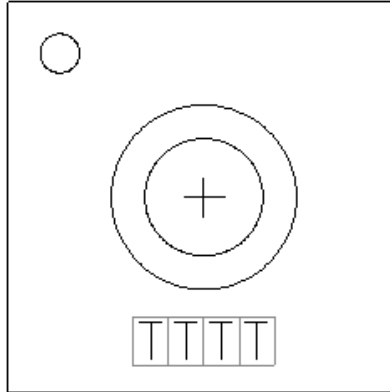

### 11.2. Top Marking Explanation

<b>Mark Method:</b>	Laser
<b>Font Size</b>	0.30 mm
<b>Pin 1 Indicator:</b>	Circle = 0.30 mm Diameter Upper-Left Corner
<b>Line 1 Marking:</b>	TTTT = Mfg Code

## 12. Additional Reference Resources

- AN607: Si70xx Humidity Sensor Designer's Guide

## DOCUMENT CHANGE LIST

### Revision 0.9 to Revision 0.91

- Updated Table 2 on page 4.

### Revision 0.91 to Revision 1.0

- Updated document revision to 1.0.

### Revision 1.0 to Revision 1.1

- Updated Footnote 2 in Table 3.
- Updated Section “4.5. Protecting the Sensor” .
- Updated Table 9.
- Corrected a typo in the I<sup>2</sup>C sequence for no-hold mode in Section “5. I2C Interface” .
- Corrected a typo in Table 12.
- Updated Table 17 dimensions F1 and F2.

### Revision 1.1 to Revision 1.2

- Updated diagram in "5.4. Firmware Revision" on page 24.
- Updated notes in Table 18, “PCB Land Pattern Dimensions,” on page 32.
- Changed packing format from tube to cut tape for all non-tape & reel part numbers without protective filter covers.



Smart.  
Connected.  
Energy-Friendly



**Products**  
[www.silabs.com/products](http://www.silabs.com/products)



**Quality**  
[www.silabs.com/quality](http://www.silabs.com/quality)



**Support and Community**  
[community.silabs.com](http://community.silabs.com)

#### Disclaimer

Silicon Laboratories intends to provide customers with the latest, accurate, and in-depth documentation of all peripherals and modules available for system and software implementers using or intending to use the Silicon Laboratories products. Characterization data, available modules and peripherals, memory sizes and memory addresses refer to each specific device, and "Typical" parameters provided can and do vary in different applications. Application examples described herein are for illustrative purposes only. Silicon Laboratories reserves the right to make changes without further notice and limitation to product information, specifications, and descriptions herein, and does not give warranties as to the accuracy or completeness of the included information. Silicon Laboratories shall have no liability for the consequences of use of the information supplied herein. This document does not imply or express copyright licenses granted hereunder to design or fabricate any integrated circuits. The products must not be used within any Life Support System without the specific written consent of Silicon Laboratories. A "Life Support System" is any product or system intended to support or sustain life and/or health, which, if it fails, can be reasonably expected to result in significant personal injury or death. Silicon Laboratories products are generally not intended for military applications. Silicon Laboratories products shall under no circumstances be used in weapons of mass destruction including (but not limited to) nuclear, biological or chemical weapons, or missiles capable of delivering such weapons.

#### Trademark Information

Silicon Laboratories Inc., Silicon Laboratories, Silicon Labs, SiLabs and the Silicon Labs logo, CMEMS®, EFM, EFM32, EFR, Energy Micro, Energy Micro logo and combinations thereof, "the world's most energy friendly microcontrollers", Ember®, EZLink®, EZMac®, EZRadio®, EZRadioPRO®, DSPLL®, ISOmodem®, Precision32®, ProSLIC®, SiPHY®, USBXpress® and others are trademarks or registered trademarks of Silicon Laboratories Inc. ARM, CORTEX, Cortex-M3 and THUMB are trademarks or registered trademarks of ARM Holdings. Keil is a registered trademark of ARM Limited. All other products or brand names mentioned herein are trademarks of their respective holders.



Silicon Laboratories Inc.  
400 West Cesar Chavez  
Austin, TX 78701  
USA

<http://www.silabs.com>

## Looking for pricing, stock, or lifecycle information?

Click below to explore more details on WIN SOURCE:

 [View SI7021-A20-IM on WIN SOURCE](#)

 [Silicon Labs](#) Information

## Optimize Your Supply Chain with WIN SOURCE Solutions

-  Global Sourcing Solution
-  Obsolete Management
-  Cost Control Management
-  Shortage Management
-  Alternative Solution
-  Excess Inventory Management