



**THE DATASHEET OF  
SD1440-004**



# SD1440

## Silicon Phototransistor

### FEATURES

- Compact, metal can coaxial package
- 24° (nominal) acceptance angle
- Wide sensitivity ranges
- Wide operating temperature range (- 55°C to +125°C)
- Mechanically and spectrally matched to SE1450 and SE1470 infrared emitting diodes

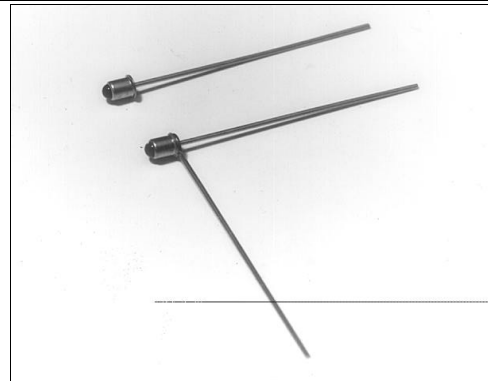

INFRA-63.TIF

### DESCRIPTION

The SD1440 is an NPN silicon phototransistor mounted in a glass lensed metal can coaxial package. The package may have a tab or second lead welded to the can as an optional feature (SD1440-XXXL). Both leads are flexible and may be formed to fit various mounting configurations.

### OUTLINE DIMENSIONS in inches (mm)

Tolerance 3 plc decimals ±0.005(0.12)  
2 plc decimals ±0.020(0.51)

#### SD1440-XXX

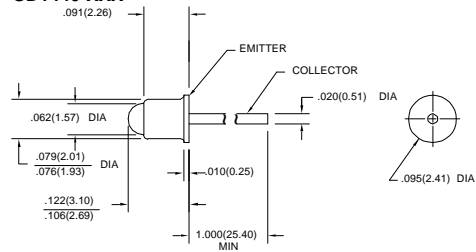

DIM\_12a.ds4

#### SD1440-XXXL

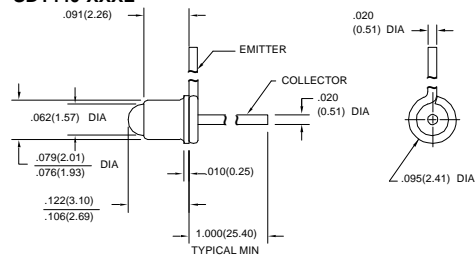

DIM\_12b.ds4

# SD1440

## Silicon Phototransistor

### ELECTRICAL CHARACTERISTICS (25°C unless otherwise noted)

PARAMETER	SYMBOL	MIN	TYP	MAX	UNITS	TEST CONDITIONS
Light Current SD1440-001, SD1440-001 L SD1440-002, SD1440-002 L SD1440-003, SD1440-003 L SD1440-004, SD1440-004 L	$I_L$	0.7 1.5 3.0 6.0			mA	$V_{CE}=5\text{ V}$ $H=5\text{ mW/cm}^2$ (1)
Collector Dark Current	$I_{CEO}$			100	nA	$V_{CE}=10\text{ V}$ , $H=0$
Collector-Emitter Breakdown Voltage	$V_{(BR)CEO}$	30			V	$I_C=100\text{ }\mu\text{A}$
Emitter-Collector Breakdown Voltage	$V_{(BR)ECO}$	5.0			V	$I_E=100\text{ }\mu\text{A}$
Collector-Emitter Saturation Voltage	$V_{CE(SAT)}$			0.4	V	$I_C=0.4\text{ mA}$ $H=5\text{ mW/cm}^2$
Angular Response (2)	$\emptyset$		24		degr.	$I_F=\text{Constant}$
Rise And Fall Time	$t_r, t_f$		15		$\mu\text{s}$	$V_{CC}=5\text{ V}$ , $I_L=1\text{ mA}$ $R_L=1000\text{ }\Omega$

#### Notes

- The radiation source is a tungsten lamp operating at a color temperature of 2870°K.
- Angular response is defined as the total included angle between the half sensitivity points.

### ABSOLUTE MAXIMUM RATINGS

(25°C Free-Air Temperature unless otherwise noted)

Collector-Emitter Voltage	30 V
Emitter-Collector Voltage	5 V
Power Dissipation	75 mW (1)
Operating Temperature Range	-55°C to 125°C
Storage Temperature Range	-65°C to 150°C
Soldering Temperature (10 sec)	260°C

#### Notes

- Derate linearly from 25°C free-air temperature at the rate of 0.71 mW/°C.

### SCHEMATIC

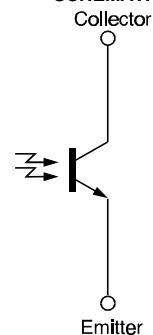

Honeywell reserves the right to make changes in order to improve design and supply the best products possible.

# Honeywell

# SD1440

## Silicon Phototransistor

SWITCHING TIME TEST CIRCUIT

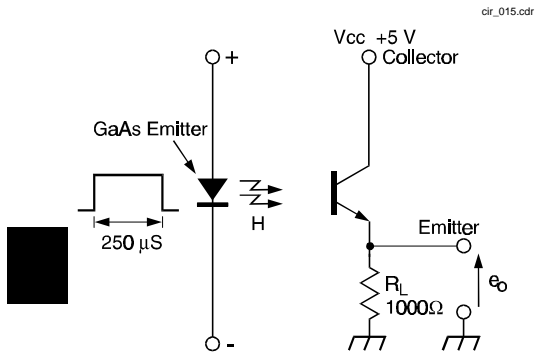

Fig. 1 Responsivity vs Angular Displacement

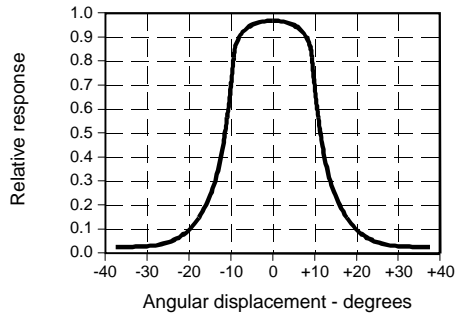
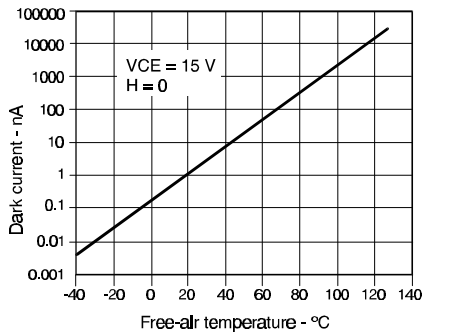

Fig. 3 Dark Current vs Temperature



SWITCHING WAVEFORM

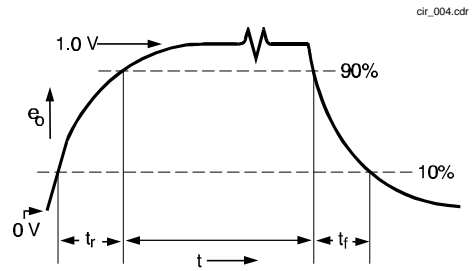

Fig. 2 Collector Current vs Ambient Temperature

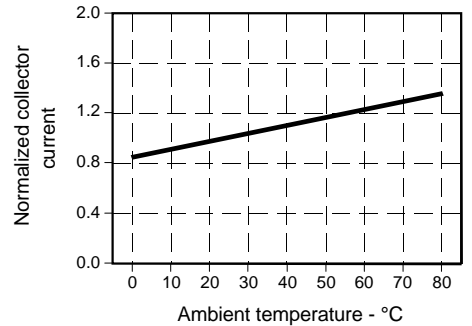
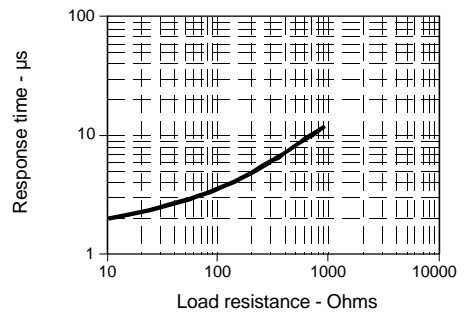

Fig. 4 Non-Saturated Switching Time vs Load Resistance



# SD1440

Silicon Phototransistor

Fig. 5 Spectral Responsivity

gra\_036.ds4

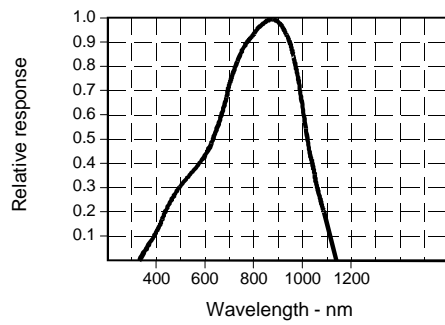
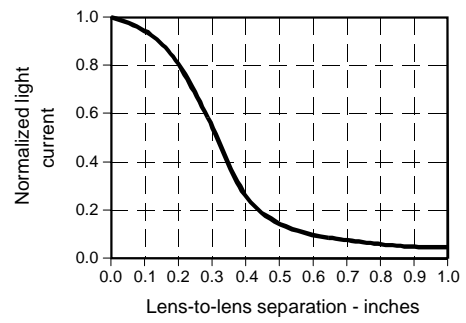

Fig. 6 Coupling Characteristics with SE1450

gra\_006.ds4



All Performance Curves Show Typical Values

## Looking for pricing, stock, or lifecycle information?

Click below to explore more details on WIN SOURCE:

 [View SD1440-004 on WIN SOURCE](#)

 [Honeywell Information](#)

## Optimize Your Supply Chain with WIN SOURCE Solutions

-  Global Sourcing Solution
-  Obsolete Management
-  Cost Control Management
-  Shortage Management
-  Alternative Solution
-  Excess Inventory Management