



**THE DATASHEET OF
ST150PG2SPGF**



Stainless Steel Pressure Sensors

ST Series

FEATURES

- Amplified output which eliminates the cost of external amplifiers
- Reverse polarity protection prevents damaged from reversed excitation
- Less than 500 μ s response time for accurate high speed measurements
- Exceeds CE Heavy Industrial EMC
- High value with outstanding performance

TYPICAL APPLICATIONS

- Pneumatic equipment
- Air compressors
- Air filtration monitoring
- Industrial controls



The Model ST pressure transducer combines Honeywell's proven silicon pressure sensing with the latest in ASIC technology in a rugged, industrial package. High value, coupled with outstanding performance, make this an ideal transducer for industrial control applications such as air compressors and pneumatic equipment. Temperature compensated, calibrated, and amplified, the ST has pressure ranges from 0 psi to 5.0 psi to 0 psi to 250 psi.

The ST offers three standard output options for user flexibility, which are as follows: a 0.50 Vdc to 4.50 Vdc ratiometric output from 5.0 Vdc excitation, a 0.50 Vdc to 4.50 Vdc regulated output from 7.0 Vdc to 35.0 Vdc excitation, or a 4 mA to 20 mA output from 9.5 Vdc to 35.0 Vdc. The ST transducer delivers $\pm 1.0\%$ full scale accuracy (BFSL) over a wide temperature range of $-40\text{ }^{\circ}\text{C}$ to $100\text{ }^{\circ}\text{C}$ [$-40\text{ }^{\circ}\text{F}$ to $212\text{ }^{\circ}\text{F}$] and utilizes a proven industry standard connector for high reliability.

⚠ WARNING

PERSONAL INJURY

DO NOT USE these products as safety or emergency stop devices or in any other application where failure of the product could result in personal injury.

Failure to comply with these instructions could result in death or serious injury.

⚠ WARNING

MISUSE OF DOCUMENTATION

- The information presented in this product sheet is for reference only. Do not use this document as a product installation guide.
- Complete installation, operation, and maintenance information is provided in the instructions supplied with each product.

Failure to comply with these instructions could result in death or serious injury.

Stainless Steel Pressure Sensors

ST Series

SPECIFICATIONS

Pressure Ranges¹

psig 0 to 5.0, 10.0, 15.0, 25.0, 50.0, 100, 150, 200, and 250
bar 0 to 0.4, 0.6, 1.0, 1.6, 2.5, 4.0, 6.0, 10.0, and 16.0

Physical

Proof Pressure	≤150 psi [6.0 bar], 3 X rated range >150 psi [6.0 bar], 2 X rated range
Burst Pressure	≤100 psi [6.0 bar], 5 X rated range >100 psi [6.0 bar], 3 X rated range
Material in contact with media	300 series stainless steel or brass, internal seal, silicon, polyetherimide
Weight	2.0 oz [57.0 gm]

Environmental²

Shock	50 g's peak [5 milliseconds]
Vibration	Figure 514.2-5, Curve AK, Table 514.2-V, Random Vibration Test [Overall g rms = 20.7 minimum]

Electrical³

	Voltage	Current
Null Offset	0.5 Vdc	4.0 MA
Span	4.0 Vdc [0.50 Vdc to 4.50 Vdc]	16 mA [4 mA to 20 mA]
Excitation Ratiometric Regulated	5.0 Vdc ±250 mV [7.0 Vdc max.] 7.0 Vdc to 35.0 Vdc	9.5 Vdc to 35.0 Vdc
Supply Current	5.0 mA typical [7.0 mA max.]	N/A
Source (nominal)	2.0 mA	N/A
Sink (nominal)	20 µA @ zero output	N/A
Supply Rejection Ratio	90 decibels	N/A
Output Impedance	25 Ω max.	N/A

Performance³

Response Time	< 500 µs
EMI/RFI	Exceeds CE heavy industrial [30v/m radiated 150 kHz to 1 GHz]
Electrical Connection	Packard Metri-Pack™ requires mating connector P/N3685901 (order separately)
Accuracy	±1.0% F.S.O. best fit straight line includes: non-linearity, hysteresis, non-repeatability. Thermal errors are not included.
Total Error Band	±2% F.S.O. Includes: zero offset error, span error, thermal effect on zero and thermal effect on span, non-linearity, hysteresis, non-repeatability
Compensated Operating and Storage Temperature Range	Range -40 °C to 100 °C [-40 °F to 212 °F]

Notes:

1. Contact the factory to discuss other pressure ranges.
2. Meets IEC-68-2 or MIL-STD 810C.
3. All specifications are measured at 25 °C [77 °F] and at rated excitation unless otherwise specified.

Stainless Steel Pressure Sensors

ST Series

HOW TO ORDER

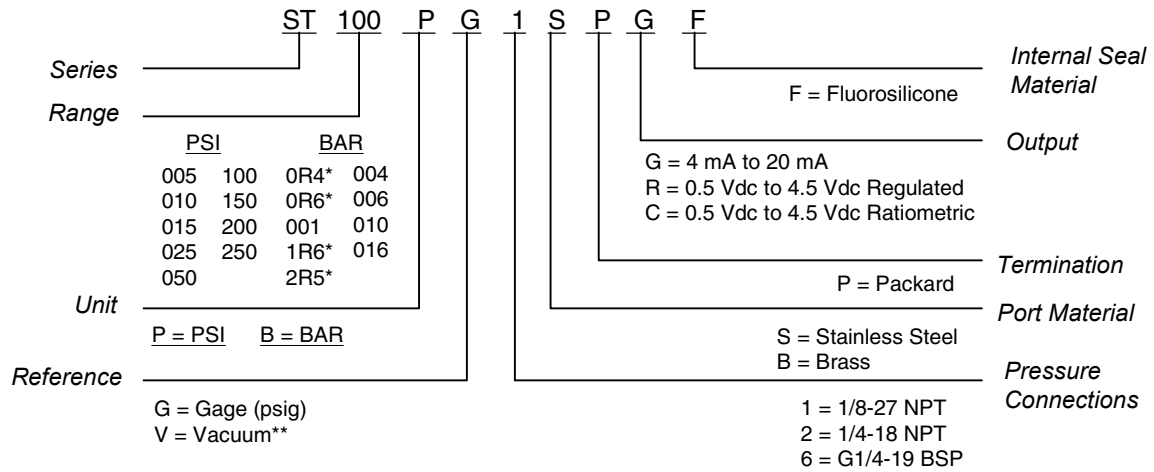

* The character R replaces the decimal point in fractional pressure ranges.

** For 015 pressure range only, full scale output at -14.7 psi.

Note: Not all combinations are available. Minimum quantity orders apply. Contact Honeywell for more details

Stainless Steel Pressure Sensors

ST Series

DIMENSIONS (for reference only) mm (in)

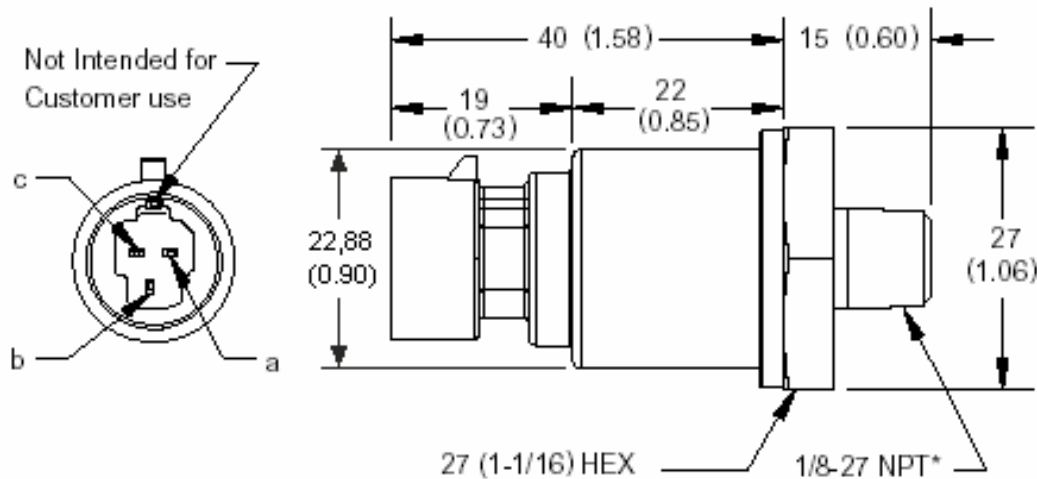

* 1/4-18 NPT and G1/4-19 BSP configurations are both optional.
Contact Honeywell to discuss other pressure port options.

PIN AND WIRE CODES

Pins	Voltage	Current
a	+ Excitation	+ Excitation
b	Output	- Excitation
c	Common	No Connection

WARRANTY/REMEDY

Honeywell warrants goods of its manufacture as being free of defective materials and faulty workmanship. Contact your local sales office for warranty information. If warranted goods are returned to Honeywell during the period of coverage, Honeywell will repair or replace without charge those items it finds defective. **The foregoing is Buyer's sole remedy and is in lieu of all other warranties, expressed or implied, including those of merchantability and fitness for a particular purpose.**

Specifications may change without notice. The information we supply is believed to be accurate and reliable as of this printing. However, we assume no responsibility for its use.

While we provide application assistance personally, through our literature and the Honeywell web site, it is up to the customer to determine the suitability of the product in the application.

For application assistance, current specifications, or name of the nearest Authorized Distributor, contact a nearby sales office. Or call:

1-800-537-6945 USA

1-800-737-3360 Canada

1-815-235-6847 International

FAX

1-815-235-6545 USA

INTERNET

www.honeywell.com/sensing

info.sc@honeywell.com

Honeywell

Sensing and Control

Honeywell

11 West Spring Street

Freeport, Illinois 61032

008083-1-EN_IL50_GLO_803 Printed in USA
Copyright 2003 Honeywell International Inc.

www.honeywell.com/sensing

Looking for pricing, stock, or lifecycle information?

Click below to explore more details on WIN SOURCE:

 [View ST150PG2SPGF on WIN SOURCE](#)

 [Honeywell Information](#)

Optimize Your Supply Chain with WIN SOURCE Solutions

-  Global Sourcing Solution
-  Obsolete Management
-  Cost Control Management
-  Shortage Management
-  Alternative Solution
-  Excess Inventory Management