



THE DATASHEET OF SX15AD4





*Representative photograph,
actual product appearance
may vary.*

*Due to regional agency
approval requirements,
some products may not be
available in your area.
Please contact your
regional Honeywell office
regarding your product of
choice.*

SX15AD4

Pressure Sensors: Measurement Type: Absolute; 0 psia to 15 psia, Unamplified, "D4" DIP Package - Straight Port

Features

- Low Cost
- High-Impedance Bridge
- Absolute and Differential (Gauge)
- Low Noise
- Low Power Consumption for Battery Power

Typical Applications

- Medical
- Instrumentation
- Barometric
- Measurement
- Pneumatic Controls
- Battery Powered Equipment

Description

The SX Series pressure sensors provide the lowest cost components for measuring pressures up to 150 psi. These sensors are designed for use with non-corrosive, non-ionic media, such as air and dry gases. Convenient pressure ranges are available to measure differential, gauge, and absolute pressures from 0 psi to 1 psi (SX01) up to 0 psi to 150 psi (SX150).

The Absolute (A) devices have an internal vacuum reference and an output voltage proportional to absolute pressure. The differential (D) devices allow application of pressure to either side of the diaphragm and can be used for gauge or differential pressure measurements.

This product is packaged in either the standard low cost chip carrier "button" package, a plastic ported "N" package, or a DIP package.

All packages are designed for applications where the sensing element is integral to the OEM equipment. These packages can be o-ring sealed, epoxied, and/or clamped onto a pressure fitting. A closed-bridge four pin SIP configuration is provided for electrical connection to the "Button" or "N" Package. The DIP Package mounts on a PC board like a standard IC with through-hole pins. This extremely small size package enables the use of multiple sensors in applications with limited space.



SX15AD4

Pressure Sensors: Measurement Type: Absolute; 0 psia to 15 psia, Unamplified, "D4" DIP Package - Straight Port

Product Specifications	
Measurement Type	Absolute
Signal Conditioning	Unamplified
Pressure Range	0 psia to 15 psia
Maximum Overpressure	45 psia
Supply Voltage	12 Vdc max.
Compensated	No
Output Calibration	No
Response Time	100 μ S
Termination	PCB
Port Style	Straight
Package Style	D4 DIP
Typical Sensitivity	1.5 mV/V/psi
Full Scale Span	75 mV min., 110 mV typ., 150 mV max.
Zero Pressure Offset	-35.0 mV min., -20.0 mV typ., 0.0 mV max.
Linearity, Repeatability & Hysteresis Error	- 0.5 min., 0.2 typ., 0.5 max. % Full Scale Span
Repeatability	0.5 % span
Input Resistance	4.1 kOhms typ.
Output Resistance	4.1 kOhms typ.

Operating Temperature Range	-40 °C to 85 °C [-40 °F to 185 °F]
Storage Temperature Range	-55 °C to 125 °C [-67 °F to 257 °F]
Media Compatibility	Clean, dry gases only
UNSPSC Code	411121
UNSPSC Commodity	411121 Transducers
Comment	Lead Temperature Soldering 2 s to 4 s at 250 °C [482 °F]
Availability	Global
Series Name	SX Series

Honeywell

SX15AD4

Pressure Sensors: Measurement Type: Absolute; 0 psia to 15 psia, Unamplified, "D4"
DIP Package - Straight Port

For Reference Only mm (in)

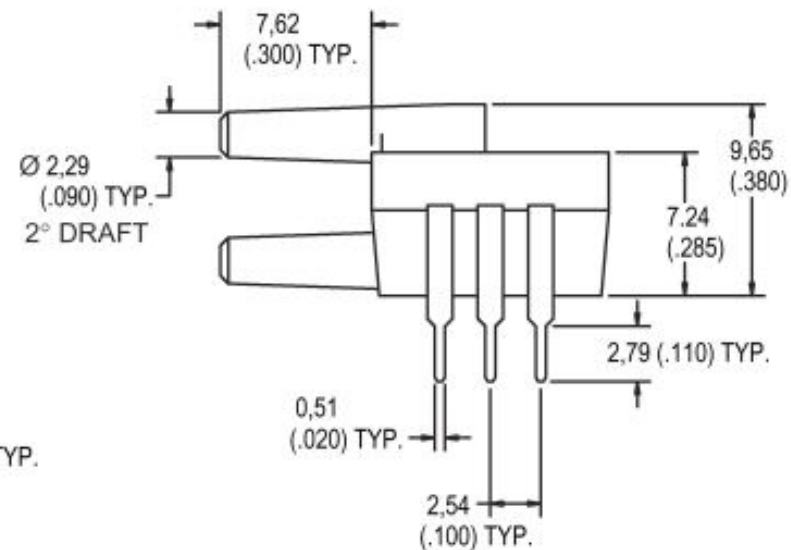
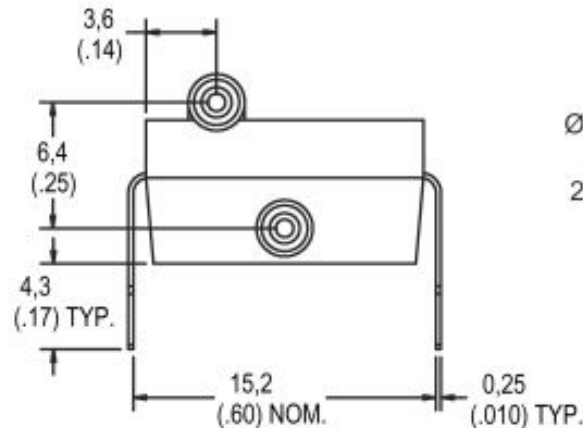
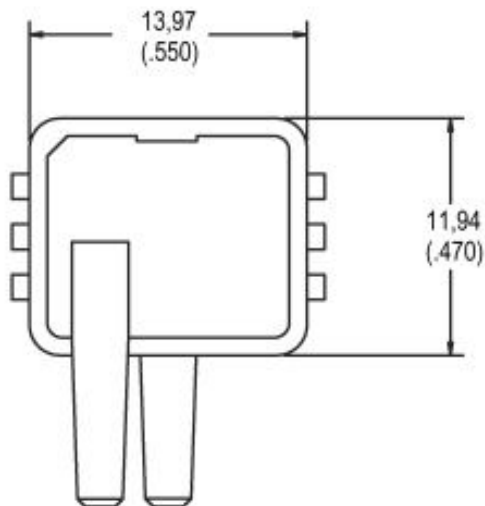

Honeywell

SX15AD4

Pressure Sensors: Measurement Type: Absolute; 0 psia to 15 psia, Unamplified, "D4"
DIP Package - Straight Port

[Electrical Connections]

Honeywell

SX15AD4

Pressure Sensors: Measurement Type: Absolute; 0 psia to 15 psia, Unamplified, "D4"
DIP Package - Straight Port

[Equivalent circuit]

Honeywell

SX15AD4

Pressure Sensors: Measurement Type: Absolute; 0 psia to 15 psia, Unamplified, "D4"
DIP Package - Straight Port

WARNING

PERSONAL INJURY

DO NOT USE these products as safety or emergency stop devices, or in any other application where failure of the product could result in personal injury.

Failure to comply with these instructions could result in death or serious injury.

 WARNING

MISUSE OF DOCUMENTATION

- The information presented in this product sheet (or catalog) is for reference only. DO NOT USE this document as product installation information.
- Complete installation, operation and maintenance information is provided in the instructions supplied with each product.

Failure to comply with these instructions could result in death or serious injury.

© Copyright Honeywell Inc.1998-2004 All rights reserved.

Looking for pricing, stock, or lifecycle information?

Click below to explore more details on WIN SOURCE:

 [View SX15AD4 on WIN SOURCE](#)

 [Honeywell Information](#)

Optimize Your Supply Chain with WIN SOURCE Solutions

-  Global Sourcing Solution
-  Obsolete Management
-  Cost Control Management
-  Shortage Management
-  Alternative Solution
-  Excess Inventory Management