

Silicon Pressure Sensors

SX 0 psi to 1 psi to 0 psi to 150 psi

SX Series

FEATURES

- Low Cost
- High-Impedance Bridge
- Absolute and Differential (Gauge)
- Low Noise
- Low Power Consumption for Battery Power

TYPICAL APPLICATIONS

- Medical
- Instrumentation
- Barometric
- Measurement
- Pneumatic Controls
- Battery Powered Equipment

EQUIVALENT CIRCUITS

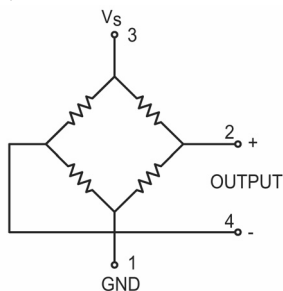

Button, Nipple and N Packages

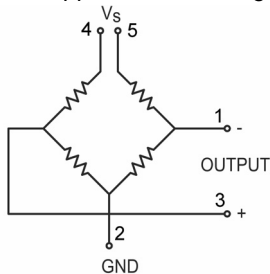

DIP Packages

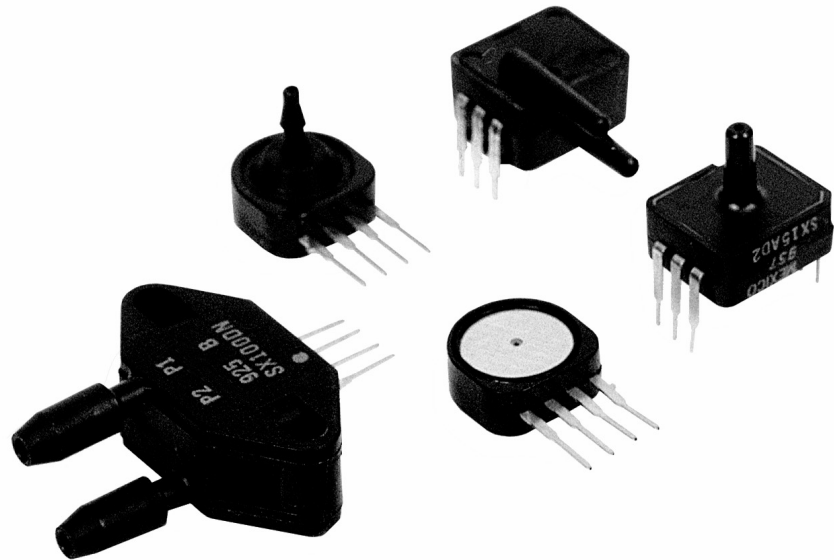

GENERAL DESCRIPTION

The SX Series pressure sensors provide the lowest cost components for measuring pressures up to 150 psi. These sensors are designed for use with non-corrosive, non-ionic media, such as air and dry gases. Convenient pressure ranges are available to measure differential, gauge, and absolute pressures from 0 psi to 1 psi (SX01) up to 0 psi to 150 psi (SX150).

The Absolute (A) devices have an internal vacuum reference and an output voltage proportional to absolute pressure. The differential (D) devices allow application of pressure to either side of the diaphragm and can be used for gauge or differential pressure measurements.

This product is packaged in either the standard low cost chip carrier "button" package, a plastic ported "N" package, or a DIP package. All packages are designed for applications where the sensing element is integral to the OEM equipment. These packages can be o-ring sealed, epoxied, and/or clamped onto a pressure fitting. A closed-bridge four pin SIP configuration is provided for electrical connection to the "Button" or "N" Package. The DIP Package mounts on a PC board like a standard IC with through-hole pins. This extremely small size package enables the use of multiple sensors in applications with limited space.

WARNING

PERSONAL INJURY

DO NOT USE these products as safety or emergency stop devices or in any other application where failure of the product could result in personal injury.

Failure to comply with these instructions could result in death or serious injury.

WARNING

MISUSE OF DOCUMENTATION

- The information presented in this product sheet is for reference only. Do not use this document as a product installation guide.
- Complete installation, operation, and maintenance information is provided in the instructions supplied with each product.

Failure to comply with these instructions could result in death or serious injury.

Silicon Pressure Sensors

SX 0 psi to 1 psi to 0 psi to 150 psi

SX Series

CHARACTERISTICS (Maximum Ratings For All Devices)

Supply Voltage, V_S	12 Vdc
Operating Temperature Range	-40 °C to 85 °C [-40 °F to 185 °F]
Storage Temperature Range	-55 °C to 125 °C [-67 °F to 257 °F]
Humidity	0 % to 100 % RH
Common-mode Pressure	150 psig
Lead Soldering Temperature	250 °C [482 °F] 2 sec to 4 sec

PERFORMANCE CHARACTERISTICS⁽¹⁾

Characteristic Description	Min.	Typ.	Max.	Unit
Zero Pressure Offset ⁽²⁾	-35.0	-20.0	0.0	mV
Temperature Coefficient of Offset ^(3,4)	–	4	–	$\mu\text{V}/\text{V}/^\circ\text{C}$
Combined Pressure Non-Linearity, and Hysteresis ⁽⁵⁾	–	0.2	± 0.5	%FSS
Long Term Stability of Offset and Span ⁽⁶⁾	–	0.1	–	%FSS
Response Time ⁽⁷⁾	–	100	–	μs
Input Resistance	–	4.1	–	k Ω
Temperature Coefficient of Resistance ^(3,4)	690	750	810	ppm/ $^\circ\text{C}$
Temperature Coefficient of Span ^(3,4)	-2550	-2150	-1900	ppm/ $^\circ\text{C}$
Output Resistance	–	4.1	–	k Ω
Repeatability ⁽⁸⁾	–	0.5	–	%FSS

SX PERFORMANCE CHARACTERISTICS⁽¹⁾

Part Number	Operating Pressure Range	Sensitivity (mV/V/psi)	Full-Scale Span ⁽⁹⁾ (mV)			Burst Pressure
			Typ	Min.	Typ.	
SX01	0 psi to 1 psi	4.0	15	20	25	20 psi
SX05	0 psi to 5 psi	3.0	50	75	100	20 psi
SX15	0 psi to 15 psi	1.5	75	110	150	45 psi
SX30	0 psi to 30 psi	0.75	75	110	150	90 psi
SX100	0 psi to 100 psi	0.3	100	150	200	150 psi
SX150	0 psi to 150 psi	0.15	75	110	150	200 psi

Specification Notes:

- Note 1:** Reference Conditions; $T_A = 25\text{ }^\circ\text{C}$ [77 °F], Supply $V_S = 5\text{ Vdc}$; Common Line Pressure = 0 psig, Pressure Applied to P1
- Note 2:** The zero pressure offset is 0 mV minimum to -20 mV typical and 35 mV maximum for part numbers SXxxxGD2 and SXxxxDD4.
- Note 3:** Slope of best straight line fit from 0°C to 70°C. For operation outside this temperature range, contact factory for more information.
- Note 4:** This parameter is not 100% tested. It is guaranteed by process design.
- Note 5:** Pressure Hysteresis - the maximum output difference at any point within the operating pressure range for increasing and decreasing pressure. Pressure Non-linearity the maximum deviation of measure output, at constant temperature (25 °C [77 °F]), from “best straight line” through three points (offset pressure, full-scale pressure, one-half full scale pressure).
- Note 6:** Long term stability over a one year period.
- Note 7:** Response time for a 0 psi to Full-Scale Span pressure step change, 10% to 90% rise time.
- Note 8:** Maximum difference in output at any pressure within the operating pressure range and the temperature range within 0 °C to 70 °C [32 °F to 158 °F] after:
- 100 temperature cycles, 0 °C and 70 °C [32 °F to 158 °F]
 - 1 million pressure cycles, 0 psi to full-scale span.
- Note 9:** Full-scale span is the algebraic difference between the output voltage at full-scale pressure and the output at zero pressure. Full-scale span is ratiometric to the supply voltage.
- Note 10:** Exceeding maximum pressure can cause permanent sensor failure

Silicon Pressure Sensors

SX 0 psi to 1 psi to 0 psi to 150 psi

SX Series

ELECTRICAL CONNECTIONS

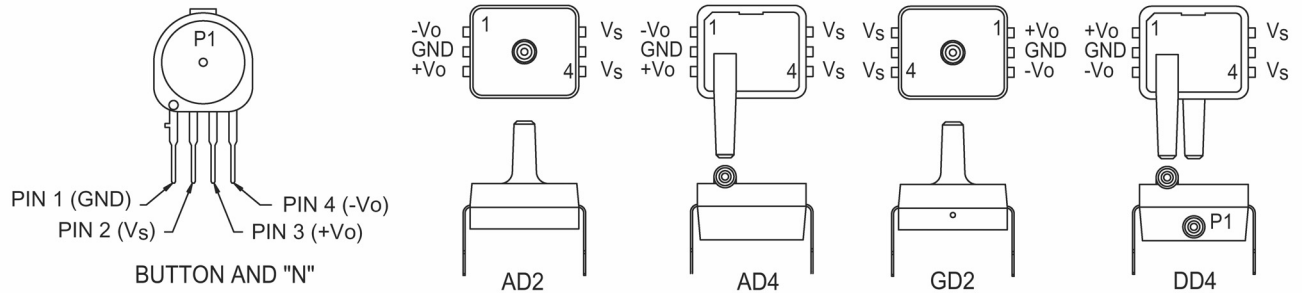

ORDERING INFORMATION

Pressure Range	Order Part Number			
	Button Package	Nipple Package	"N" Package	DIP Package
0 to 1 psid or psig	SX01D	SX01DP1	SX01DN	SX01GD2, SX01DD4
0 to 5 psid or psig	SX05D	SX05DP1	SX05DN	SX05GD2, SX05DD4
0 psia to 15 psia	SX15A	SX15AP1	SX15AN	SX15AD2, SX15AD4
0 psia to 30 psia	SX30A	SX30AP1	SX30AN	SX30AD2, SX30AD4
0 psia to 100 psia	SX100A	—	SX100AN	SX100AD2, SX100AD4
0 psia to 150 psia	SX150A	—	SX150AN	—
0 to 15 psid or psig	SX15D	SX25DP1	SX15DN	SX15GD2, SX15DD4
0 to 30 psid or psig	SX30D	SX30DP1	SX30DN	SX30GD2, SX30DD4
0 to 100 psid or psig	SX100D	—	SX100DN	SX100GD2, SX100DD4
0 to 150 psid or psig	SX150D	—	—	—

PHYSICAL DIMENSIONS for reference only mm [In]

Button Package

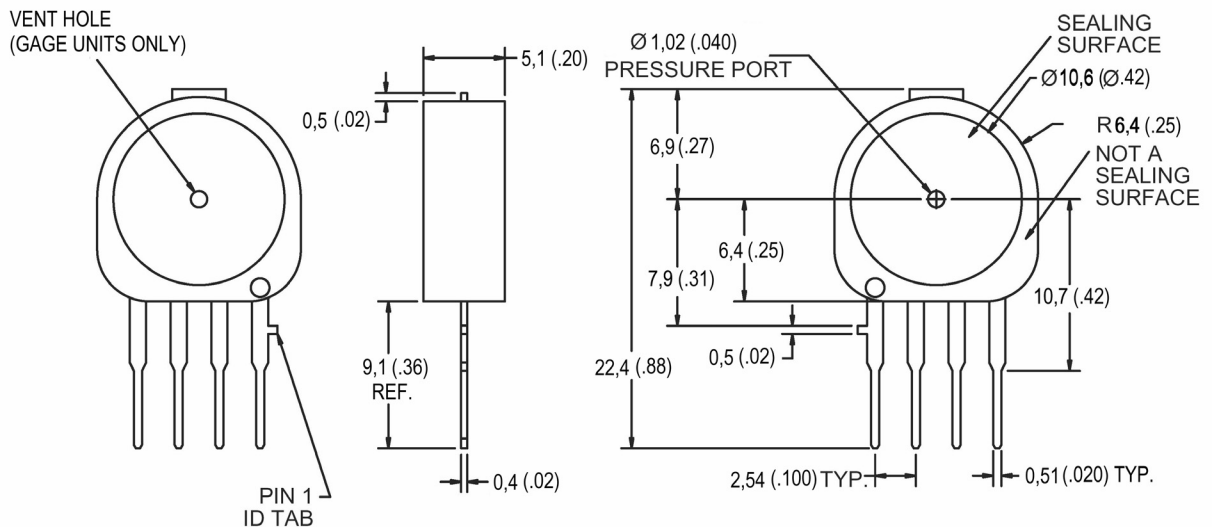

Silicon Pressure Sensors

SX 0 psi to 1 psi to 0 psi to 150 psi

SX Series

Nipple Package

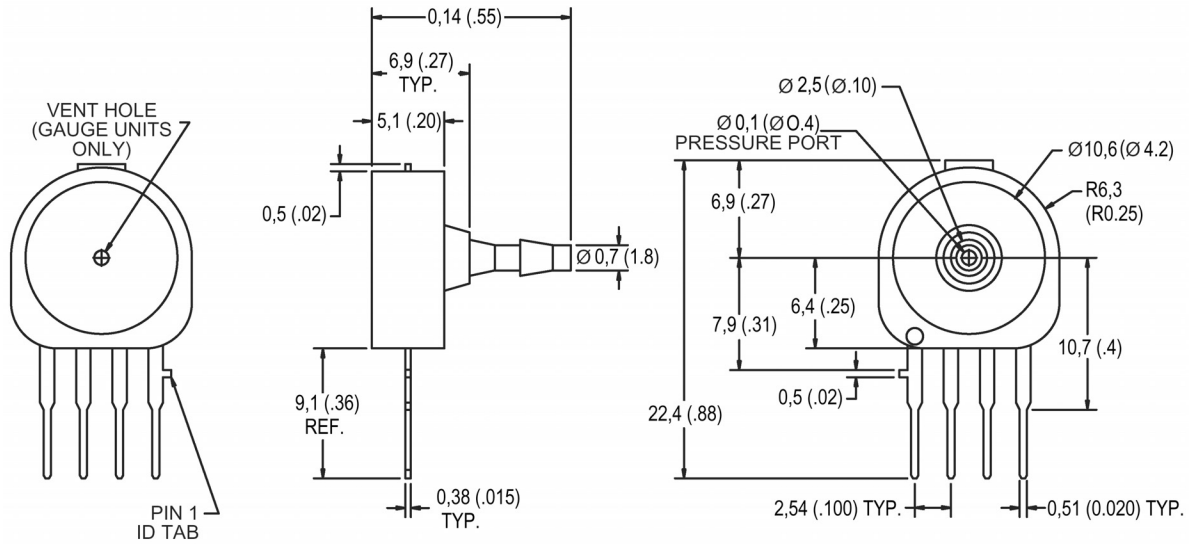

N Housing Package

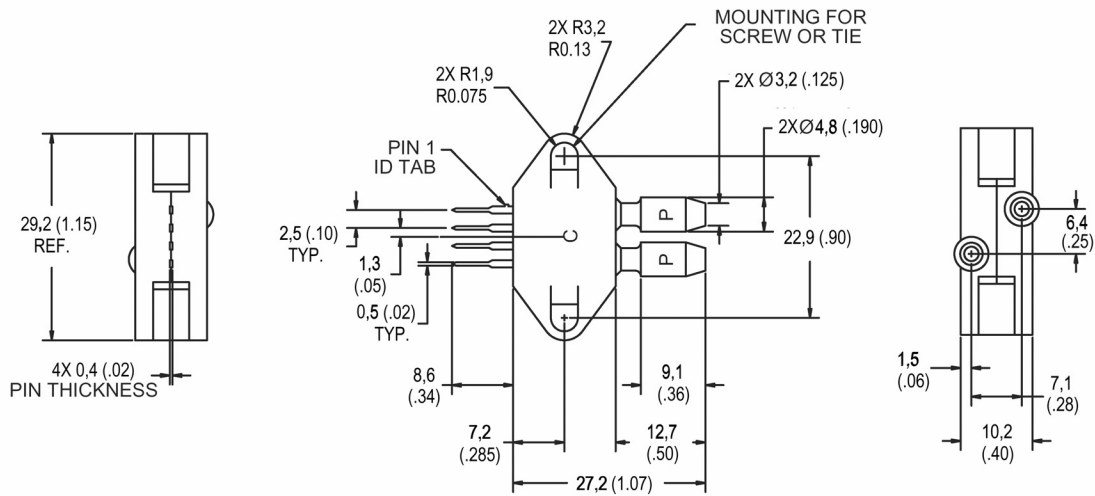

Silicon Pressure Sensors

SX 0 psi to 1 psi to 0 psi to 150 psi

SX Series

D2 DIP Package

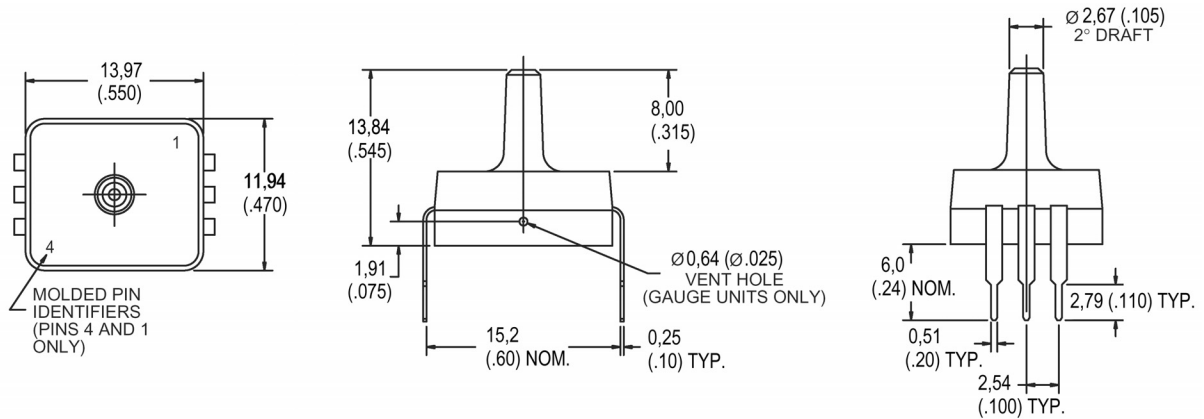

DD4 DIP Package

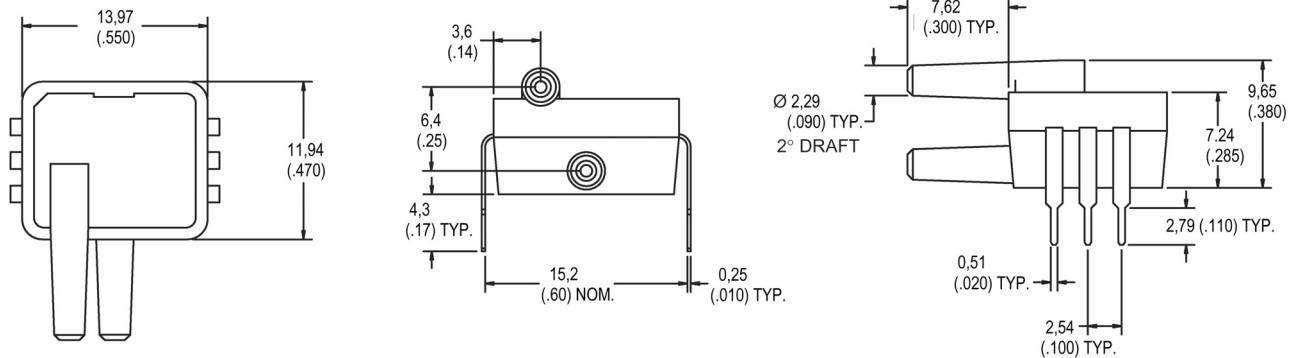

AD4 DIP Package

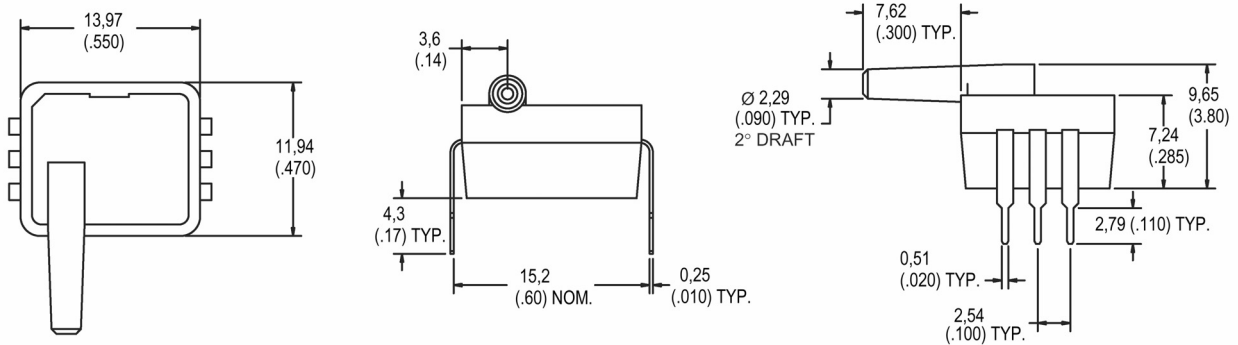

Silicon Pressure Sensors

SX 0 psi to 1 psi to 0 psi to 150 psi

SX Series

WARRANTY/REMEDY

Honeywell warrants goods of its manufacture as being free of defective materials and faulty workmanship. Contact your local sales office for warranty information. If warranted goods are returned to Honeywell during the period of coverage, Honeywell will repair or replace without charge those items it finds defective. **The foregoing is Buyer's sole remedy and is in lieu of all other warranties, expressed or implied, including those of merchantability and fitness for a particular purpose.**

Specifications may change without notice. The information we supply is believed to be accurate and reliable as of this printing. However, we assume no responsibility for its use.

While we provide application assistance personally, through our literature and the Honeywell web site, it is up to the customer to determine the suitability of the product in the application.

For application assistance, current specifications, or name of the nearest Authorized Distributor, contact a nearby sales office. Or call:

1-800-537-6945 USA/Canada

1-815-235-6847 International

FAX

1-815-235-6545 USA

INTERNET

www.honeywell.com/sensing

info.sc@honeywell.com

Honeywell

Sensing and Control

www.honeywell.com/sensing

Honeywell

11 West Spring Street

Freeport, Illinois 61032

Looking for pricing, stock, or lifecycle information?

Click below to explore more details on WIN SOURCE:

 [View SX01DP1 on WIN SOURCE](#)

 [Honeywell Information](#)

Optimize Your Supply Chain with WIN SOURCE Solutions

-  Global Sourcing Solution
-  Obsolete Management
-  Cost Control Management
-  Shortage Management
-  Alternative Solution
-  Excess Inventory Management