

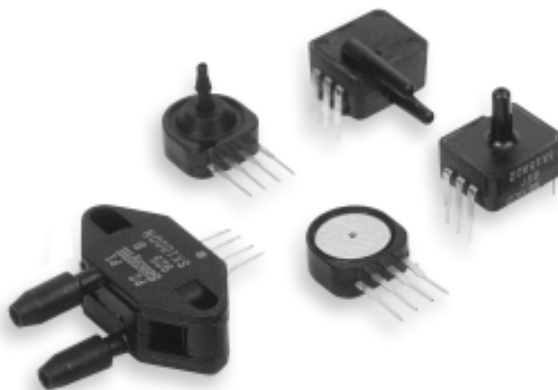

# THE DATASHEET OF SCC30GD2





## SCC Series

### Silicon pressure sensors 0 psi to 5 psi and 0 psi to 300 psi

#### DESCRIPTION

The SCC Series sensors offer an extremely low cost sensor element with a temperature stable output when driven with a constant current source. These integrated circuit sensors were designed for extremely cost sensitive applications where precise accuracy over a wide temperature range is not required. This series is intended for use with non-corrosive, non-ionic working fluids such as air, and dry gases.

Absolute devices have an internal vacuum reference and an output voltage proportional to applied pressure. The differential devices allow application of pressure to either side

#### FEATURES

- Low cost sensor element
- Internal temperature compensation
- Differential or gage pressures

#### ORDERING INFORMATION

Pressure Range	Part Number for Ordering			
	Sensor in Button Package	Sensor in "N" Package	Sensor in Nipple Package	Sensor in DIP Package
0 psid to 5 psid or psig	SCC05D	SCC05DN	SCC05DP1	SCC05GD2, SCC05DD4
0 psid to 15 psid or psig	SCC015D	SCC015DN	SCC015DP1	SCC15GD2, SCC15DD4
0 psid to 30 psid or psig	SCC30D	SCC30DN	SCC30DP1	SCC30GD2, SCC30DD4
0 psig to 100 psig	SCC100D	SCC100DN	–	SCC100GD2, SCC100DD4
0 psia to 15 psia	SCC15A	SCC15AN	SCC15AP1	SCC15AD2
0 psia to 30 psia	SCC30A	SCC30AN	SCC30AP1	SCC30AD2
0 psia to 100 psia	SCC100A	SCC100AN	–	SCC100AD2
0 psia to 300 psi	–	–	–	–

of the diaphragm and devices are thereby available to measure both differential and gage pressures.

This product is packaged either in standard low cost chip carrier "button" package or a DIP package. Both packages are designed for applications where the sensing element is to be integral to the OEM equipment. These packages can be o-ring sealed, epoxied, and/or clamped onto a pressure fitting. A closed bridge four pin SIP configuration is provided for electrical connection to the button package. The DIP package offers a 5-pin open bridge configuration.

#### TYPICAL APPLICATIONS

- Pneumatic controls
- Automotive diagnostics
- Medical equipment
- Dental equipment
- Environmental controls

#### **⚠ WARNING**

##### **MISUSE OF DOCUMENTATION**

- The information presented in this product sheet is for reference only. Do not use this document as a product installation guide.
- Complete installation, operation, and maintenance information is provided in the instructions supplied with each product.

**Failure to comply with these instructions could result in death or serious injury.**

#### **⚠ WARNING**

##### **PERSONAL INJURY**

DO NOT USE these products as safety or emergency stop devices or in any other application where failure of the product could result in personal injury.

**Failure to comply with these instructions could result in death or serious injury.**

# SCC Series

## SPECIFICATION CHARACTERISTICS (Maximum Ratings for All Devices)

Supply current, $I_s$	1.5 mA
Compensated temperature range	0 °C to 50 °C [32 °F to 122 °F]
Operating temperature range	-40 °C to 85 °C [-40 °F to 185 °F]
Storage temperature range	-55 °C to 125 °C [-67 °F to 257 °F]
Humidity	0 % to 100 % RH
Lead temperature	250 °C [482 °F] Soldering 2 sec to 4 sec
Common-mode pressure	150 psi

## PERFORMANCE CHARACTERISTICS (Individual Models) $I_s=1.0$ mA, $T_a=25$ °C [77 °F]<sup>(1)</sup>

Part Number	Operating Pressure Range	Maximum Over Pressure	Accuracy <sup>(2)</sup>	Effect <sup>(3, 4)</sup> on Span 0 °C to 50 °C	Effect <sup>(5, 4)</sup> on Offset 0 °C to 50 °C	Full-Scale Span <sup>(6)</sup> mV
SCC05(D,G)	0 psid to 5 psid (g)	20 psi	0.50 %	1.50 %	30 $\mu$ V/°C	25-65
SCC15A	0 psia to 15 psia	30 psia	0.50 %	1.50 %	40 $\mu$ V/°C	40-95
SCC15(D,G)	0 psid to 15 psid (g)	30 psi	0.50 %	1.50 %	40 $\mu$ V/°C	40-95
SCC30(D,G)	0 psid to 30 psid (g)	60 psi	0.50 %	1.50 %	60 $\mu$ V/°C	60-150
SCC100A	0 psia to 100 psia	150 psia	0.50 %	1.50 %	30 $\mu$ V/°C	85-225
SCC100(D,G) <sup>(7)</sup>	0 psig to 100 psig	150 psig	0.50 %	1.50 %	90 $\mu$ V/°C	85-225
SCC300A	0 psia to 300 psia	450 psia	0.50 %	1.50 %	50 $\mu$ V/°C	50-120

## PERFORMANCE SPECIFICATIONS (All Models) $I_s=10.0$ Ma, $T_a=25$ °C [77 °F]

	Min.	Typ.	Max.	Unit
Zero Pressure Offset <sup>(8)</sup>	-30.0	-10.0	20.0	mV
Combined Linearity, Hysteresis and Repeatability <sup>(2)</sup>	–	0.25	0.50	% FSO
Long Term Stability of Offset and Span <sup>(9)</sup>	–	0.10	–	mV
Response Time (10 % to 90 %) <sup>(10)</sup>	–	0.10	–	ms
Input Impedance	4.00	5.00	6.50	kOhm
Output Impedance	4.00	5.00	6.50	kOhm

### Specification Notes:

**Note 1:** Reference Conditions; Supply Current = 1.0 mA;  $T_a = 25$  °C [77 °F], Common-mode Line Pressure = 0 psig, Pressure Applied to P1, unless otherwise noted.

**Note 2:** Accuracy is the sum of Hysteresis and Linearity. Hysteresis is the maximum output difference at any point within the operating pressure range for increasing and decreasing pressure. Linearity refers to the best straight line fit as measured for the offset, full-scale and ½ full-scale pressure at 25 °C [77 °F].

**Note 3:** This is the maximum temperature shift for span when measured between 0 °C and 50 °C [32 °F to 122 °F] relative to the 25 °C [77 °F] reading. Typical temperature coefficients for span and resistance are -2200 ppm/°C and 2200 ppm/°C respectively.

**Note 4:** Temperature effect on span and offset are guaranteed by design. Therefore these parameters are not 100 % tested.

**Note 5:** This is the maximum temperature shift for offset when measured at 0 °C and 50 °C [32 °F to 122 °F] divided by the temperature difference.

**Note 6:** Span is the algebraic difference between the output voltage at full-scale pressure and the output at zero pressure.

**Note 7:** The SCC100D devices can only be used in a forward gauge mode. Application of more than 30 psig to the back side of any of the SCC Series devices can result in device failure. On the SCC100GD2 pressure can only be applied to the back side of the die. No pressure is accessible from the front/top side of die.

**Note 8:** The zero pressure offset is 30 to -20 mV max. form parts SCCxxxGD2 and SCCxxDD4 devices.

**Note 9:** Maximum difference in output at any pressure with the operating pressure range and temperature within 0 °C and 50 °C [32 °F to 122 °F].

a) 100 temperature cycles, 0 °C and 50 °C [32 °F to 122 °F]

b) 1.0 million pressure cycles, 0 psi to full-scale span.

**Note 10:** Response time for a 0 psi to full-scale span pressure step change. 10 % to 90 % rise time.

# Silicon pressure sensors

## ELECTRICAL CONNECTIONS

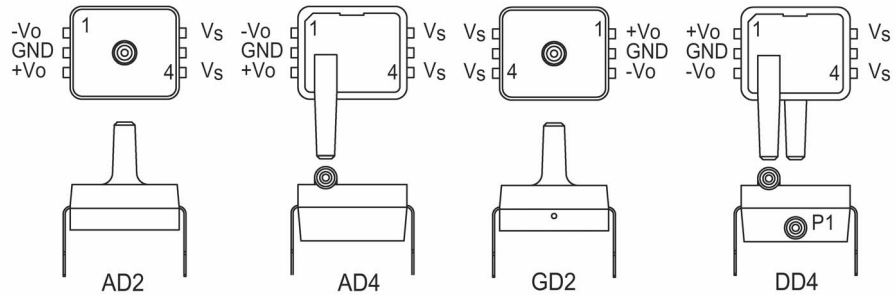
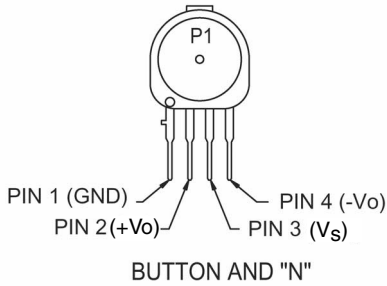

## EQUIVALENT CIRCUITS

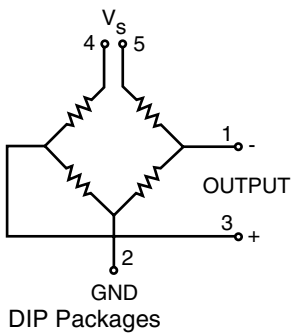
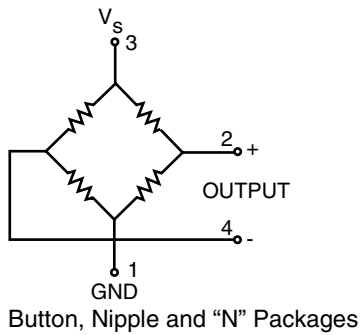

## MOUNTING DIMENSIONS IN MM (INCHES), FOR REFERENCE ONLY

### Button package

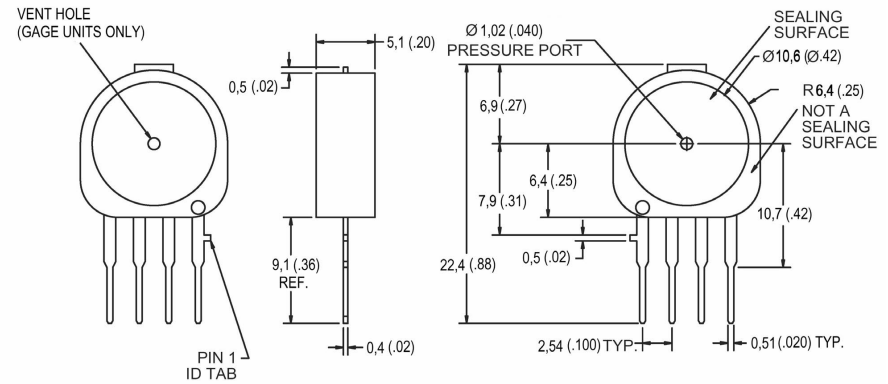

### Nipple package

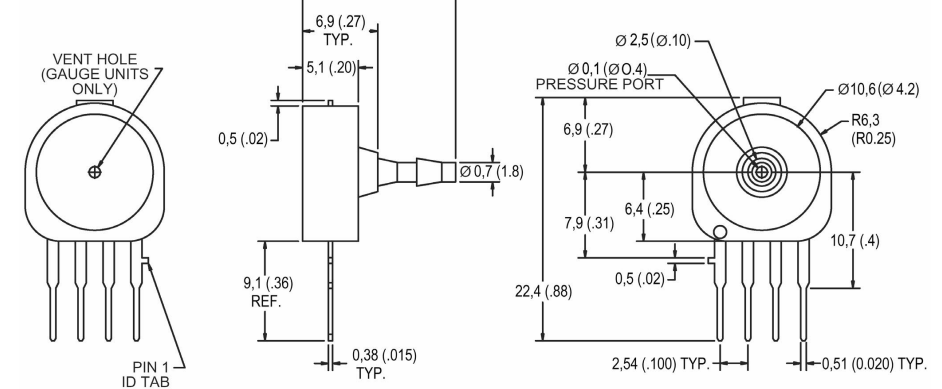

### N Housing package

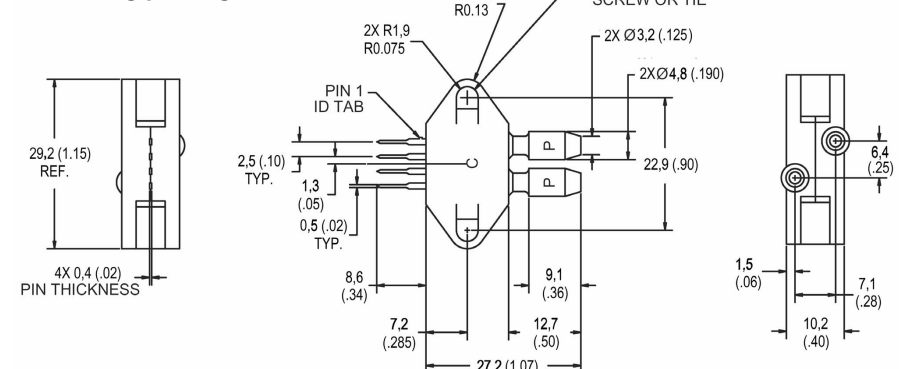

## D2 DIP package

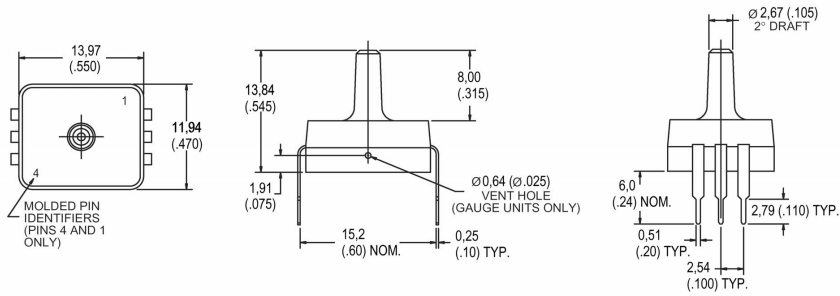

## DD4 DIP package

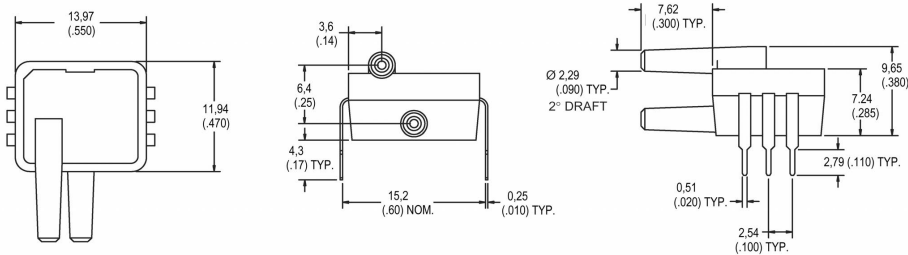

## AD4 DIP package

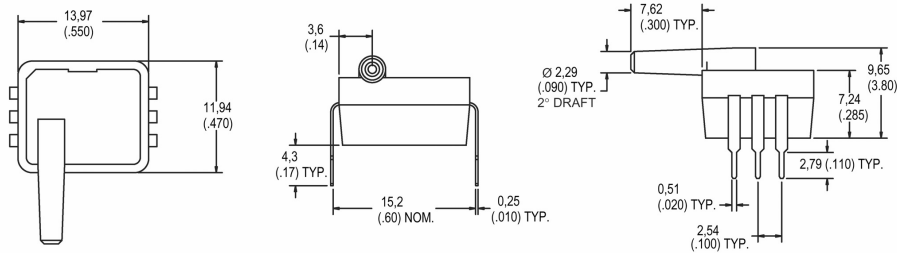

## WARRANTY/REMEDY

Honeywell warrants goods of its manufacture as being free of defective materials and faulty workmanship. Honeywell's standard product warranty applies unless agreed to otherwise by Honeywell in writing; please refer to your order acknowledgement or consult your local sales office for specific warranty details. If warranted goods are returned to Honeywell during the period of coverage, Honeywell will repair or replace, at its option, without charge those items it finds defective. **The foregoing is buyer's sole remedy and is in lieu of all warranties, expressed or implied, including those of**

**merchantability and fitness for a particular purpose. In no event shall Honeywell be liable for consequential, special, or indirect damages.**

While we provide application assistance personally, through our literature and the Honeywell web site, it is up to the customer to determine the suitability of the product in the application.

Specifications may change without notice. The information we supply is believed to be accurate and reliable as of this printing. However, we assume no responsibility for its use.

## SALES AND SERVICE

Honeywell serves its customers through a worldwide network of sales offices, representatives and distributors. For application assistance, current specifications, pricing or name of the nearest Authorized Distributor, contact your local sales office or:

**E-mail:** [info.sc@honeywell.com](mailto:info.sc@honeywell.com)

**Internet:** [www.honeywell.com/sensing](http://www.honeywell.com/sensing)

### Phone and Fax:

Asia Pacific +65 6355-2828  
+65 6445-3033 Fax  
Europe +44 (0) 1698 481481  
+44 (0) 1698 481676 Fax  
Latin America +1-305-805-8188  
+1-305-883-8257 Fax  
USA/Canada +1-800-537-6945  
+1-815-235-6847  
+1-815-235-6545 Fax

## Automation and Control Solutions

Sensing and Control  
Honeywell  
11 West Spring Street  
Freeport, Illinois 61032, USA  
[www.honeywell.com](http://www.honeywell.com)

008135-2-EN IL50 GLO  
May 2005  
Copyright 2004-2005 Honeywell International Inc.

# Honeywell







## Looking for pricing, stock, or lifecycle information?

Click below to explore more details on WIN SOURCE:

 [View SCC30GD2 on WIN SOURCE](#)

 [Honeywell Information](#)

## Optimize Your Supply Chain with WIN SOURCE Solutions

-  Global Sourcing Solution
-  Obsolete Management
-  Cost Control Management
-  Shortage Management
-  Alternative Solution
-  Excess Inventory Management