



**THE DATASHEET OF
SCN-1461SC**



Ultrasonic Sensors

Compact 18 mm Diameter Digital

940 Series

FEATURES

- Sensing distance up to 1,5 meters
- 18 mm diameter housing
- IP 67 sealing
- High output current
- High power transducer
- Microprocessor controlled

ORDER GUIDE

Sensor Package Style	Sensing Range* mm (in.)	Digital Output	Termination	Catalog Listing
18 mm dia. PBTB Plastic 	200 - 1500 (7.87 - 59.05)	PNP, N.O.	Cable	940-F4Y-2D-001-180E
		NPN, N.O.	Cable	940-F4Y-2D-002-180E
		PNP, N.O.	Connector cable	940-F4X-2D-001-180E
		NPN, N.O.	Connector cable	940-F4X-2D-002-180E
	150 - 700 (5.9 - 27.5)	PNP, N.O.	Cable	940-F4Y-2D-001-300E
		NPN, N.O.	Cable	940-F4Y-2D-002-300E
		PNP, N.O.	Connector cable	940-F4X-2D-001-300E
		NPN, N.O.	Connector cable	940-F4X-2D-002-300E

* Standard target is 120 mm square of mild steel perpendicular to ultrasonic beam.

SPECIFICATIONS

Catalog Listings	940-F4Y-2D-001-180E 940-F4Y-2D-002-180E 940-F4X-2D-001-180E 940-F4X-2D-002-180E	940-F4Y-2D-001-300E 940-F4Y-2D-002-300E 940-F4X-2D-001-300E 940-F4X-2D-002-300E
Max. Sensing Distance	1500 mm (59.05 in.)	700 mm (27.5 in.)
Min. Sensing Distance	200 mm (7.87 in.)	150 mm (5.91 in.)
Beam Angle	8°	8°
POWER SUPPLY		
Supply Voltage	19 - 30 VDC	
Supply Current	<25 mA without load	<35 mA without load
Circuit Protection	Reverse polarity	
OUTPUT CHARACTERISTICS		
Load Current	0 - 500 mA	
Switching Frequency	8 Hz	25 Hz
Hysteresis	~ 2% of setpoint	~ 2.5% of setpoint
Repeatability	± 1 mm	
Setpoint Adjustment	4-turn potentiometer	
Circuit Protection	Short circuit	
ENVIRONMENTAL		
Operating Temperature	-15 to 70°C (5 to 158°F)	
Storage Temperature	-25 to 85°C (-13 to 185°F)	
Sealing	IP 67	
SPECIAL FEATURES		
Hold Input	Stops transmission and reception when input is connected to 0 VDC. Last output will be stored until input is disconnected	
Synchronization Input	Avoids mutual interference from several sensors by interconnecting the hold input from each sensor.	
LED Indicator	Illuminates when sensor detects target	

Ultrasonic Sensors

940 Series

Compact 18 mm Diameter Digital

WIRING DIAGRAM

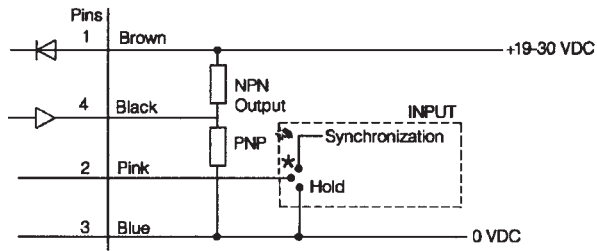

940-F4X/Y-20-001/2-300E Versions only

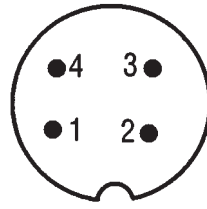

4-pin DC Micro (M12 x 1)

Pin	Color
1	BRN
2	PINK
3	BLU
4	BLK

*Normal operation with no connection

MOUNTING DIMENSIONS (For reference only)

940-F4X/Y-20-001/2-180E

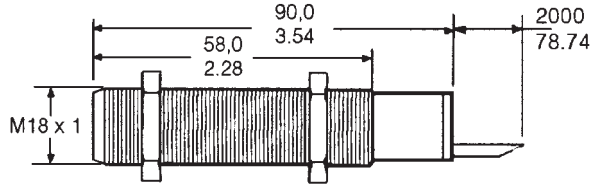

940-F4X/Y-2D-001/2-300E

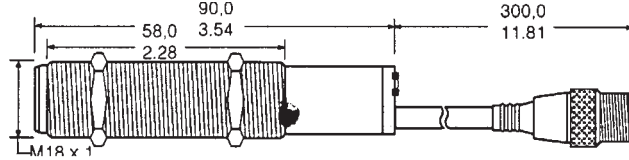

ACCESSORIES

	Catalog Listing	Feature
Mounting clamp	43178389-018	Allows mounting to a flat surface
Beam deflector	43192871-003	Allows right angle mounting (Approx. dim. 50 x 170 mm)
Focusing beam deflector	43192871-004	Reduces beam angle by approximately 1/2 (Approx. dim. 35 x 52 mm)
Straight connector w/o cable	66195044-001	Connector has screw terminals for wiring connection
Right angle connector w/o cable	66195045-001	Connector has screw terminals for wiring connection
24 VDC Power supply, Relay output, 110 VAC input	FF-MADB24RB	See page B102 for more information
24 VDC Power supply, On/Off delay, 110 VAC input	FF-MADC24RB	See page B102 for more information

Proximity

Ultrasonic Sensors

30 mm Diameter Analog

940 Series

FEATURES

- Measuring range up to 2000 mm (78.74 in.)
- High repeatability

ORDER GUIDE

Sensor Package Style	Sensing Range* mm (in.)	Analog Output	Termination	Catalog Listing
 30 mm dia. Stainless Steel	300 - 2000 (11.81 - 78.74)	1.5 - 10 V	Cable	940-A4Y-AD-1C0-130E
	150 - 1200 (5.90 - 47.24)	1.25 - 10 V	Cable	940-A4Y-AD-1C0
			Connector	940-A4V-AD-1C0

* Standard target is 120 mm square of mild steel perpendicular to ultrasonic beam.

SPECIFICATIONS

Catalog Listings	940-A4Y-AD-1C0-130E		940-A4Y-AD-1C0 940-A4V-AD-1C0	
	Max. Range	Max. Rate	Max. Range	Max. Rate
Max. Sensing Distance	2000 mm (78.74 in.)	1000 mm (39.37 in.)	1200 mm (47.2 in.)	600 mm (23.6 in.)
Min. Sensing Distance	300 mm (11.8 in.)		150 mm (5.91 in.)	
Beam Angle	8°		10°	
POWER SUPPLY				
Supply Voltage	19 - 30 VDC			
Supply Current	<20 mA without load			
Circuit Protection	Reverse polarity			
OUTPUT CHARACTERISTICS				
Load Current	10 mA max.			
Switching Frequency	6 Hz		11 Hz	
Repeatability	±2 mm		±1 mm	
Linearity	<0.2%			
Output Adjustment	4 Turn Potentiometer			
Output Mode	Max. Range or Max. Rate selected by wiring terminal connection			
Circuit Protection	Short Circuit			
ENVIRONMENTAL				
Operating Temperature	0 to 50°C (32 to 122°F)			
Storage Temperature	0 to 70°C (32 to 158°F)			
Sealing	IP 65			
SPECIAL FEATURES				
Hold Input	Stops transmission and reception of sensor when input is connected to 0 VDC. Analog output would be zero.			
Synchronization Input	Avoids mutual interference from several ultrasonic sensors (external synchronization unit required; see Accessories)			
LED Indicator	Illuminates when sensor detects a target			

Ultrasonic Sensors

940 Series

30 mm Diameter Analog

WIRING DIAGRAM

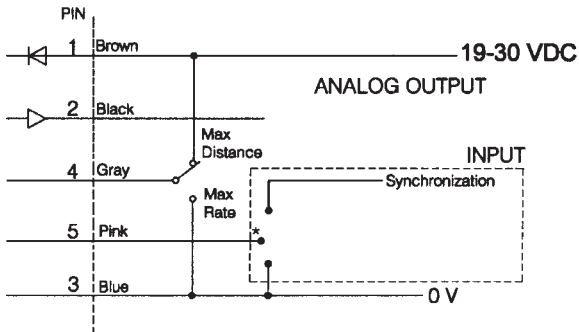

*Normal operation with connection +19-30 VDC

CONNECTOR VERSION ONLY

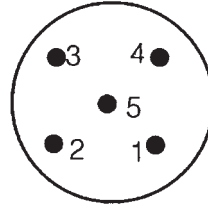

Pin	Color
1	BRN
2	WHT
3	BLU
4	BLK
5	GRAY

MOUNTING DIMENSIONS (For reference only)

940-A4V-AD-1C0

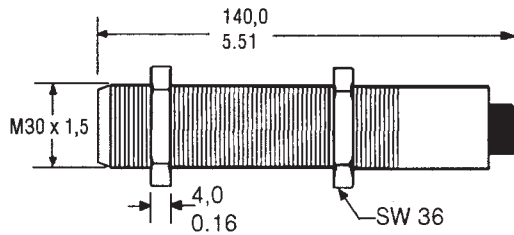

940-A4Y-AD-1C0-130E 940-A4Y-AD-1C0

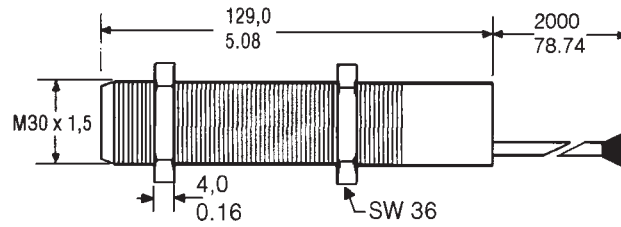

ACCESSORIES

	Catalog Listing	Feature
Mounting clamp, 30 mm sensor	43178389-030	Allows mounting to a flat surface
Beam deflector	43192871-001	Allows right angle mounting (Approx. dim. 50 x 170 mm)
Focusing beam deflector	43192871-002	Reduces beam angle by approximately 1/2
Compact deflector	66195116-001	Allows right angle mounting (Approx. dim. 35 x 52 mm)
2 meter cable, Straight connector	RKT5-612/2M	Used for wiring to connector version
5 meter cable, Straight connector	RKT5-612/5M	Used for wiring to connector version
2 meter cable, Right angle connector	RKWT5-612/2M	Used for wiring to connector version
5 meter cable, Right angle connector	RKWT5-612/5M	Used for wiring to connector version
Synchronization unit	55000001	Controls up to 100 sensors

Proximity

Compact 30 mm Diameter Analog and Digital, RS232/RS485 Interface

FEATURES

- Programmable
- RS232 or RS485 interface
- 0 - 10 VDC/4 - 20 mA output
- Two N.O. PNP outputs or one N.O. PNP/one N.C. PNP output

ORDER GUIDE

Sensor Package Style	Sensing Range* mm (in.)	Analog Output	Digital Output	Interface	Catalog Listing
30 mm dia. Stainless Steel  272,1g (9.6 oz)	300 - 3000 (11.8 - 118)	0 - 10 V	PNP, N.O./N.C.	RS232	942-A4N-2D-1C1-130E
		4 - 20 mA	PNP, N.O./N.C.	RS232	942-A4N-2D-1D1-130E
		0 - 10 V	PNP, N.O./N.C.	RS485	942-A4N-2D-1E1-130E
		4 - 20 mA	PNP, N.O./N.C.	RS485	942-A4N-2D-1F1-130E
	150 - 1500 (5.9 - 59.1)	0 - 10 V	PNP, N.O./N.C.	RS232	942-A4N-2D-1C1-220S
		4 - 20 mA	PNP, N.O./N.C.	RS232	942-A4N-2D-1D1-220S
		0 - 10 V	PNP, N.O./N.C.	RS485	942-A4N-2D-1E1-220S
		4 - 20 mA	PNP, N.O./N.C.	RS485	942-A4N-2D-1F1-220S
	100 - 600 (3.94 - 23.6)	0 - 10 V	PNP, N.O./N.C.	RS232	942-A4N-2D-1C1-300E

* Standard target is 120 mm square of mild steel perpendicular to ultrasonic beam.

SPECIFICATIONS

Catalog Listings	942-A4N-2D-1C1-130E 942-A4N-2D-1D1-130E 942-A4N-2D-1E1-130E 942-A4N-2D-1F1-130E	942-A4N-2D-1C1-220S 942-A4N-2D-1D1-220S 942-A4N-2D-1E1-220S 942-A4N-2D-1F1-220S	942-A4N-2D-1C1-300E
Max. Sensing Distance	3000 mm (118 in.)	1500 mm (59.1 in.)	600 mm (23.6 in.)
Min. Sensing Distance	300 mm (11.8 in.)	150 mm (5.91 in.)	100 mm (3.94 in.)
Beam Angle	8°	10°	8°
POWER SUPPLY			
Supply Voltage	19 - 30 VDC		
Supply Current	< 30 mA without load		
Circuit Protection	Reverse Polarity		
OUTPUT CHARACTERISTICS (DIGITAL)			
Load Current	0 - 100 mA		
Hysteresis	Programmable (0 - 255 mm)		
Switching Frequency	Programmable 5-30 Hz	Programmable 5-30 Hz	Programmable 5-50 Hz
Repeatability	±2 mm or ±0.4% of reading		
Setpoint Adjust	Programmable within sensing range		
Circuit Protection	Short circuit		
OUTPUT CHARACTERISTICS (ANALOG)			
Switching Frequency	Programmable 5-30 Hz	Programmable 5-30 Hz	Programmable 5-50 Hz
Repeatability	±2 mm or ±0.4% of reading		
Linearity	3 mm or ±0.5%		
Output Adjust	Programmable		
Circuit Protection	Short circuit		
ENVIRONMENTAL			
Operating Temperature	-15 to 70°C (5 to 150°F)		
Storage Temperature	-25 to 85°C (-13 to 185°F)		
Sealing	IP 65		
SPECIAL FEATURES			
Hold Input	Stops transmission and reception when input is connected to 0 VDC. Analog output would be zero.		
Synchronization input	Avoids mutual interference from several sensors by interconnecting the Hold input from each sensor.		
LED Indicator	Illuminates when sensor detects target		
Programmable Parameters	Analog Output: Span, Offset, Positive or Negative slope Digital Output: Hysteresis, N.O./N.C.		

Compact 30 mm Diameter Analog and Digital, RS232/RS485 Interface

WIRING DIAGRAM

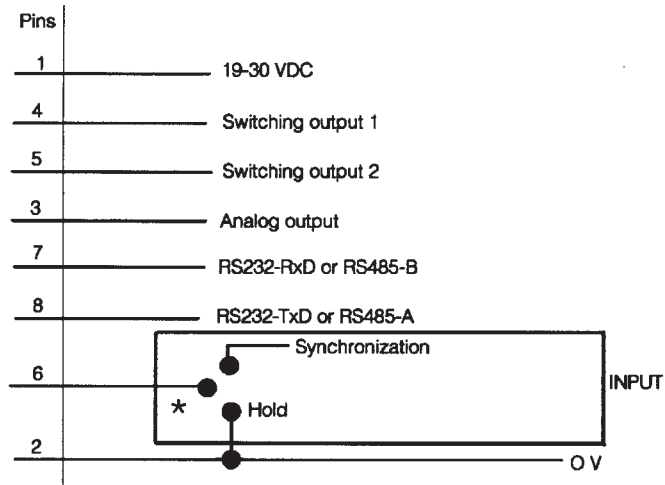

*Normal operation with no connection

MOUNTING DIMENSIONS (For reference only)

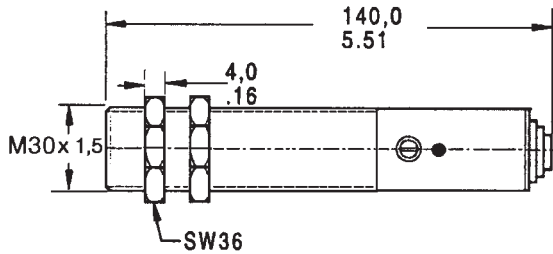

Proximity

ACCESSORIES

	Catalog Listing	Features
Mounting clamp	43178389-030	Allows mounting to flat surface
Beam deflector	43192871-001	Allows right angle mounting (approx. dim. 50 x 170 mm)
Focusing beam deflector	43192871-002	Reduces beam angle by approximately 50%
Compact deflector	66195116-001	Allows right angle mounting (approx. dim. 35 x 52 mm)
Programming adapter	55000005-002	Allows sensor programming via RS232 interface
RS232/RS485 converter	55000003-001	Converts RS232 interface to RS485 interface
24 VDC Power supply, relay output, 110 VAC input	FF-MADB24RB	See page B102 more information
24 VDC Power supply, On/Off delay, 110 VAC input	FF-MADC24RB	See page B102 more information
Software package (disk, manual, cable + 1 sub min D9 connector)	55195101-101	Allows programming of sensor
Software package (disk, manual, cable + 2 sub min D9 connectors)	55195101-102	Allows programming of sensor
Straight connector	66195126-001	Used for wiring to connector
2 meter cable with straight connector	55195126-001	Used for wiring to connector

2-Piece 30 mm Diameter Precision Switching, Analog, Digital BCD, Hexadecimal Outputs

FEATURES

- **Background suppression**
- Sensor sealed to IP 65
- Amplifier sealed to IP 54
- DIN rail mounting
- Compensated over 0 to 50°C (32 to 120°F)
- Amplifier provides analog, digital switching, BCD or hexadecimal outputs

ORDER GUIDE

Sensor Package Style	Sensing Range* mm (in.)	Digital Output**	Multiplex Digital Output	Analog Output	Catalog Listing***
30 mm (1.18 in.) Stainless steel sensor head  272g (9.6 oz)	150 - 1500 (5.9 - 59.0)	Two PNP N.O. or N.C.	BCD/HEX	0 - 10 VDC 4 - 20 mA	942-M3A-2D-1G1-220S *Standard target: 120 mm thick square of mild steel perpendicular to ultrasonic beam. **N.O./N.C. output selectable ***Includes stainless steel sensor head, cable, straight connector and amplifier.

SPECIFICATIONS

Max. Sensing Distance	1500 mm (59.1 in.)
Min. Sensing Distance	150 mm (5.91 in.)
Beam Angle	10°/5°
POWER SUPPLY	
Supply Voltage	19-30 VDC
Supply Current	< 130 mA without load
Circuit Protection	Reverse polarity
OUTPUT CHARACTERISTICS (DIGITAL)	
Load Current	0-100 mA
Hysteresis	±1% of setpoint
Switching Frequency	8 Hz
Repeatability	±1 mm or 0.2% of reading
Setpoint Adjustment	Digital switches
Output Adjustment	Beam angle 10° w/max. sensitivity or beam angle 5° w/min. sensitivity
Circuit Protection	Short circuit
OUTPUT CHARACTERISTICS (MULTIPLEX DIGITAL)	
Resolution	1 mm
Information Output	Bit Parallel/Word Serial
Setpoint Adjustment	Beam angle 10° w/max. sensitivity or beam angle 5° w/min. sensitivity
OUTPUT CHARACTERISTICS (ANALOG)	
Switching Frequency	8 Hz
Repeatability	±1 mm or 0.2% of reading
Linearity	±2 mm or 0.3%
Output Range Adjustment	Digital switches
Output Adjustment	Beam angle 10° w/max. sensitivity or beam angle 5° w/min. sensitivity
Min. Load Resistance (VDC)	1000 Ohms (0-10 VDC output)
Max. Load Resistance (mA)	250 Ohms (4-20 mA output)
Slope of Output	Positive or Negative via switch
ENVIRONMENTAL	
Operating Temperature	Sensor head: 0 to 70°C (32 to 158°F)/Amplifier: 0 to 50°C (32 to 122°F)
Storage Temperature	Sensor head/Amplifier: -25 to 85°C (-13 to 185°F)
Sealing	Sensor Head: IP 65/Amplifier: IP 54
SPECIAL FEATURES	
LED Indicators	RED - Under Range/ RED - Over Range: illumination dependent on analog range chosen and target position with respect to sensor YELLOW - Setpoint: illuminates when target reaches setpoint 1 or setpoint 2
Hold Input	Stops transmission and reception when input is connected to 0 VDC. Last output stored until input is disconnected
Synchronization Input	Avoids mutual interference from several sensors by interconnecting the hold input from each sensor

2-Piece 30 mm Diameter

Precision Switching, Analog, Digital BCD, Hexadecimal Outputs

WIRING DIAGRAM

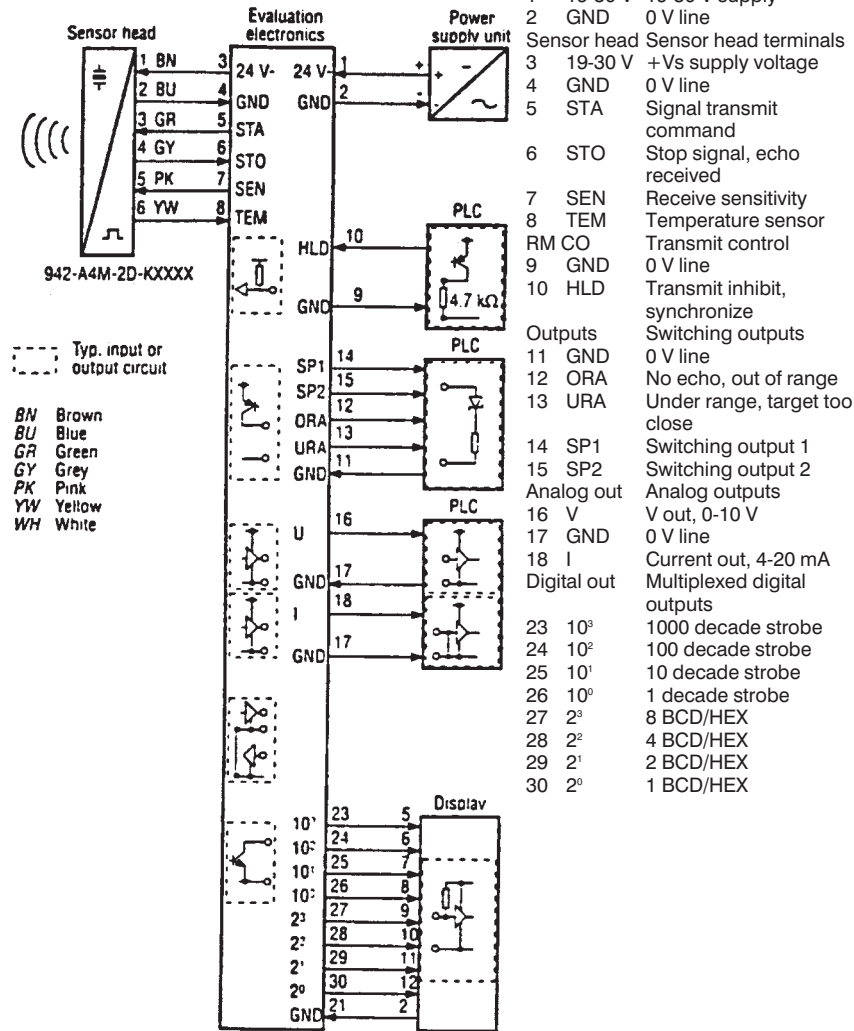

MOUNTING DIMENSIONS (For reference only)

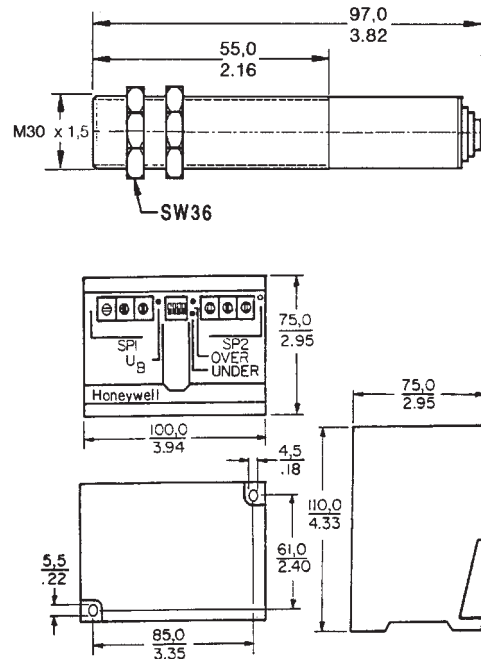

Proximity

ACCESSORIES

	Catalog Listing	Features
Mounting clamp	43178389-030	Allows mounting to flat surface
Beam deflector	43192871-001	Allows right angle mounting (approx. dim. 50 x 170 mm)
Focusing beam deflector	43192871-002	Reduces beam angle by approximately 50%
Compact deflector	66195116-001	Allows right angle mounting (approx. dim. 35 x 52 mm)

REPLACEMENT LISTINGS

Sensor Head	942A4M-2D-K220S
Amplifier	942-M0A-2D-1G1-220S
Straight Connector (cable not included)	66195074-001

942 SERIES ULTRASONIC CROSS REFERENCE

Obsolete Listing	Replacement Listing	Comments
942-M88 942-M88-LF	942-M96	Sensor head, includes connector
942-M3A-2D-1G1	942-M0A-2D-1G1-220S	Amplifier

Temperature Sensors

Platinum RTDs

HRTS Series



FEATURES

- Resistance interchangeable
- Accurate
- Linear
- Fast
- Laser trimmed
- Bolt, cement-on or strap-on models

TYPICAL APPLICATIONS

- HVAC – room, duct and refrigerant equipment
- OEM assemblies
- Electronic assemblies – semiconductor protection, temperature compensation
- Process control – temperature regulation

ORDER GUIDE

HRTS-5760-B	Miniature, ceramic body, 28 ga TFE Teflon insulated leads (2-wire only)
HRTS-61	Bolt-on, nickel plated copper alloy body, 24 ga fiberglass insulated leads, SST braid, TFE overwrap, spiral armor
-T	100Ω, 0.00385 Ω/Ω/°C, 3-wire leads, DIN specification
-U	1000Ω, 0.00375 Ω/Ω/°C, 2-wire leads
-0	±0.2% Resistance Trim (Standard)
-1	±0.1% Resistance Trim (Optional)
-12	Standard length, HRTS-5760-B
-24	Standard length, HRTS-61

MOUNTING DIMENSIONS (for reference only)

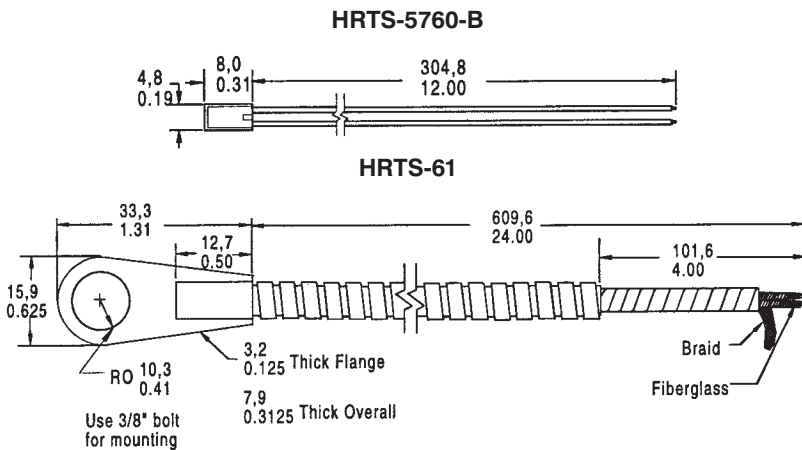

The HRTS is designed to measure surface temperatures from -200° to $+480^{\circ}$ C (-320° to $+900^{\circ}$ F) in printed circuit, temperature probe, or other applications.

HRTS surface temperature sensors are fully assembled elements, ready to use, without the need for fragile splices to extension leads.

A thin layer of platinum is deposited on an alumina substrate and laser trimmed to a resistance interchangeability of $\pm 0.2\%$ with $\pm 0.5^{\circ}$ C accuracy or $\pm 0.1\%$ with $\pm 0.3^{\circ}$ C accuracy. The sensor chip is then glassed, wired and potted or ceramic fired to result in a cylindrical alumina package with either Teflon or fiber glass insulated lead wires.

Fig. 1: Wheatstone Bridge 2-Wire Interface

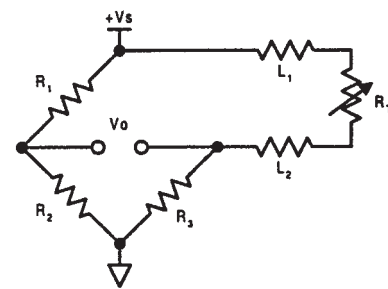

Fig. 2: Linear Output Voltage

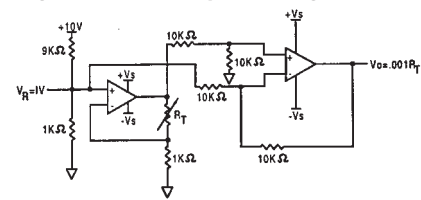
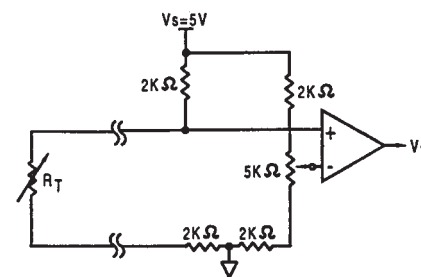

Fig. 3: Adjustable Point (Comparator) Interface



Temperature

Platinum RTDs

FUNCTIONAL BEHAVIOR

$$R_T = R_0(1 + AT + BT^2 - 100CT^3 + CT^4)$$

R_T = Resistance (Ω) at temperature T ($^{\circ}\text{C}$)

R_0 = Resistance (Ω) at 0°C

T = Temperature in $^{\circ}\text{C}$

$$A = \alpha + \frac{\alpha \delta}{100} \quad B = \frac{-\alpha \delta}{100^2} \quad C_{T < 0} = \frac{-\alpha \beta}{100^4}$$

CONSTANTS

Alpha, α ($^{\circ}\text{C}^{-1}$)	0.00375 ± 0.000029	0.003850 ± 0.000010
Delta, δ ($^{\circ}\text{C}$)	1.605 ± 0.009	1.4999 ± 0.007
Beta, β ($^{\circ}\text{C}$)	0.16	0.10863
A ($^{\circ}\text{C}^{-1}$)	3.81×10^{-3}	3.908×10^{-3}
B ($^{\circ}\text{C}^{-2}$)	-6.02×10^{-7}	-5.775×10^{-7}
C ($^{\circ}\text{C}^{-4}$)	-6.0×10^{-12}	-4.183×10^{-12}

Both $\beta = 0$ and $C = 0$ for $T > 0^{\circ}\text{C}$

ACCURACY VS TEMPERATURE

HRTS platinum RTDs are available in two base resistance trim tolerances: $\pm 0.2\%$ or $\pm 0.1\%$. The corresponding resistance interchangeability and temperature accuracy for these tolerances are:

Tolerance	Standard $\pm 0.2\%$		Optional $\pm 0.1\%$		
	Temperature ($^{\circ}\text{C}$)	$\pm \Delta R^*$ (Ω)	$\pm \Delta T$ ($^{\circ}\text{C}$)	$\pm \Delta R^*$ (Ω)	$\pm \Delta T$ ($^{\circ}\text{C}$)
	-200	6.8	1.6	5.1	1.2
	-100	2.9	0.8	2.4	0.6
	0	2.0	0.5	1.0	0.3
	100	2.9	0.8	2.2	0.6
	200	5.6	1.6	4.3	1.2
	300	8.2	2.4	6.2	1.8
	400	11.0	3.2	8.3	2.5
	500	12.5	4.0	9.6	3.0
	600	15.1	4.8	10.4	3.3

*1000 Ω RTD. Divide ΔR by 10 for 100 Ω RTD.

RESISTANCE VS TEMPERATURE CURVE

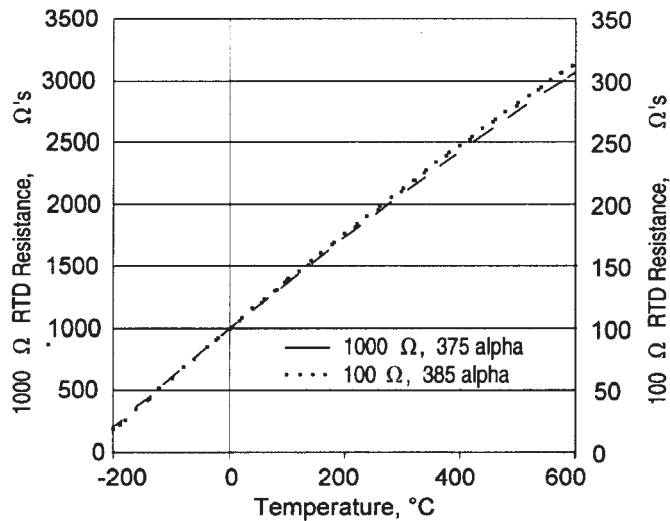

CAUTION

PRODUCT DAMAGE

The inherent design of this component causes it to be sensitive to electrostatic discharge (ESD). To prevent ESD-induced damage and/or degradation, take normal ESD precautions when handling this product.

SPECIFICATIONS

Sensor Type	Thin film platinum RTD: $R_0 = 1000 \Omega @ 0^{\circ}\text{C}$; $\alpha = 0.00375 \Omega/\Omega/^{\circ}\text{C}$ $R_0 = 100 \Omega @ 0^{\circ}\text{C}$; $\alpha = 0.00385 \Omega/\Omega/^{\circ}\text{C}$
Temperature Range	HRTS-5760-B: -200° to $+260^{\circ}\text{C}$ (-320° to $+500^{\circ}\text{F}$) HRTS-61: -75° to $+425^{\circ}\text{C}$ (-100° to $+800^{\circ}\text{F}$)
Temperature Accuracy	$\pm 0.5^{\circ}\text{C}$ or 0.8% of temperature @ 0.2% R_0 Trim $\pm 0.3^{\circ}\text{C}$ or 0.6% of temperature @ 0.1% R_0 Trim Optional
Time Constant, 1/e	HRTS-5760-B: Typically 0.6 sec. on metal surfaces HRTS-61: Typically 20 sec. On metal surfaces
Operating Current	2 mA max. for self-heating errors of 1°C 1 mA recommended
Self-Heating	0.3 mW/ $^{\circ}\text{C}$
Lead Material	Nickel coated stranded copper, Teflon or Fiberglass insulated

Ultrasonic Sensors



Precision Digital 18 mm Diameter

945 Series

FEATURES

- Background suppression
- Sealed to IP 65
- Fixed or adjustable setpoint control
- Temperature compensation over 0 to 50°C (32 to 122°F)
- Inhibit/synchronization input
- Stainless steel or plastic housings

ORDER GUIDE

Sensor Package Style	Sensing Range* mm (in.)	Setpoint	Output Type	Catalog Listing
18 mm dia. Plastic  90,7 g (3.2 oz.)	100 - 500 (3.9 - 19.68)	Fixed @ 400 mm (15.75 in.) ± 20 mm**	PNP, N.O.	945-F4Y-AD-001
			NPN, N.O.	945-F4Y-AD-002
	100 - 200 (3.9 - 7.87)	Fixed @ 200 mm (7.87 in.) ± 20 mm**	PNP, N.O.	945-N4Y-AD-001
			NPN, N.O.	945-N4Y-AD-002
200 - 500 (7.87 - 19.68)	Setpoint adjustment within sensing range	PNP, N.O.	945-F4Y-AD-001-180E	
		PNP, N.O.	945-F4Y-AD-001-300E	
18 mm dia. Stainless Steel  136 g (4.8 oz.)	100 - 500 (3.9 - 19.68)	Setpoint adjustment within sensing range	PNP, N.O.	945-L4Y-AD-001
			NPN, N.O.	945-L4Y-AD-002
	100 - 200 (3.9 - 7.87)	Setpoint adjustment within sensing range	PNP, N.O.	945-S4Y-AD-001
			NPN, N.O.	945-S4Y-AD-002

* Standard target is 120 mm square of mild steel perpendicular to ultrasonic beam.
 **External setpoint adjustment wiring possible.

SPECIFICATIONS

SENSING CHARACTERISTICS

Catalog Listings	945-F4Y-AD-001 945-F4Y-AD-002 945-L4Y-AD-001 945-L4Y-AD-002	945-N4Y-AD-001 945-N4Y-AD-002 945-S4Y-AD-001 945-S4Y-AD-002	945-F4Y-AD-001-180E	945-F4Y-AD-001-300E
Max. Sensing Distance	500 mm (19.66 in.)	200 mm (7.87 in.)	500 mm (19.66 in.)	180 mm (7.09 in.)
Min. Sensing Distance	100 mm (3.9 in.)	100 mm (3.9 in.)	200 mm (7.87 in.)	70 mm (2.76 in.)
Beam Angle	10°	10°	8°	8°
POWER SUPPLY				
Supply Voltage	19 - 30 VDC			
Supply Current	<30 mA without load		<25 mA without load	
Circuit Protection	Reverse polarity			
OUTPUT CHARACTERISTICS				
Load Current	0 - 100 mA			
Hysteresis	~ 10 mm			
Switching Frequency	30 Hz	60 Hz	25 Hz	60 Hz
Repeatability	± 0.5 mm or 0.3% or reading			± 0.2 mm or 0.2% or reading
Setpoint Adjustment	(Fixed or External Circuit) or 4 Turn Potentiometer			
Circuit Protection	Short Circuit			
ENVIRONMENTAL				
Operating Temperature	0 to 50°C (32 to 122°F)			
Storage Temperature	0 to 70°C (32 to 150°F)			
Sealing	IP 65			
SPECIAL FEATURES				
Hold Input	Stops transmission and reception when input is connected to 0 VDC. Last output will be stored until input is disconnected			
Synchronization Input	Avoids mutual interference from several sensors. (External synchronization unit is required. See Accessories)			
LED Indicator	Illuminates when sensor detects target			

Ultrasonic Sensors

Precision Digital 18 mm Diameter

945 Series

WIRING DIAGRAMS

945-F/N Series

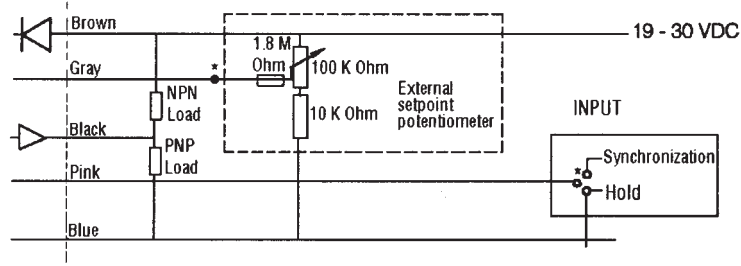

*Normal operation with no connection

MOUNTING DIMENSIONS (For reference only)

945-F/N Series plastic Housing

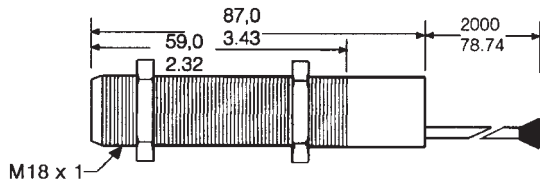

945-L/S Series

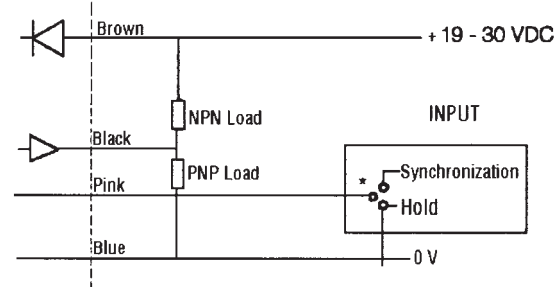

*Normal operation with no connection

945-L/S Series Stainless Steel Housing

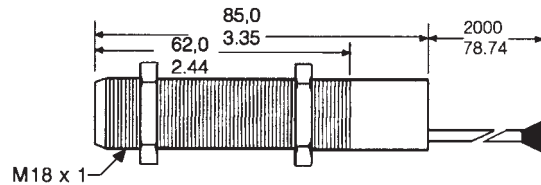

ACCESSORIES

	Catalog Listing	Features
24 VDC Power supply, relay output, 110 VAC input	FF-MADB24RB	See page B102 for more information
24 VDC Power supply, ON/OFF delay, 110 VAC input	FF-MADC24RB	See page B102 for more information
Synchronization unit	55000001	Controls up to 100 sensors
Mounting clamp, 18 mm housing	43178389-018	Allows mounting to a flat surface
Beam deflector	43192871-003	Allows right angle mounting (approx. dim. 50 x 170 mm)
Focusing beam deflector	43192871-004	Reduces beam angle by approximately 50%

Proximity

Ultrasonic Sensors



Precision Analog 18 mm Diameter

945 Series

FEATURES

- Background suppression
- Sealed to IP 65
- Adjustable sensitivity
- Temperature compensation over 0 to 50°C (32 to 122°F)
- Inhibit/synchronization input
- Stainless steel or plastic housings

ORDER GUIDE

Sensor Package Style	Sensing Range* mm (in.)	Analog Output	Catalog Listing
18 mm dia. Plastic  90,7 g (3.2 oz.)	150 - 600 (5.9 - 23.6)	1.5 - 6 V	945-F4Y-AD-1C0-180E
	60 - 200 (2.36 - 7.87)	1.8 - 6 V	945-F4Y-AD-1C0-300E
18 mm dia. Stainless Steel  136 g (4.8 oz.)	100 - 600 (3.9 - 23.6)	1 - 6 V	945-L4Y-AD-1C0
18 mm dia. Plastic with Stainless Steel or Plastic External Head 	150 - 600 (5.9 - 23.6)	1.5 - 6 V	945-E3Y-AD-1C0-180E (M18 x 1 stainless steel sensor head)
	30 - 150 (1.18 - 5.9)	0.9 - 4.5 V	945-G3Y-AD-1C0-300E (M12 x 1 plastic sensor head)

SPECIFICATIONS

Catalog Listings	945-F4Y-AD-1C0-180E	945-F4Y-AD-1C0-300E	945-L4Y-AD-1C0	945-E3Y-AD-1C0-180E	945-G3Y-AD-1C0-300E
Max. Sensing Distance	600 mm (23.6 in.)	200 mm (7.87 in.)	600 mm (23.6 in.)	600 mm (23.6 in.)	150 mm (5.9 in.)
Min. Sensing Distance	150 mm (5.9 in.)	60 mm (2.36 in.)	100 mm (3.9 in.)	150 mm (5.9 in.)	30 mm (1.18 in.)
Beam Angle	8°	8°	10°	8°	8°
POWER SUPPLY					
Supply Voltage	19 - 30 VDC				
Supply Current	<20 mA without load				
Circuit Protection	Reverse polarity				
OUTPUT CHARACTERISTICS					
Load Current	10 mA max.				
Switching Frequency	10 Hz	20 Hz	10 Hz	10 Hz	20 Hz
Repeatability	< ± 0.3% of reading				
Linearity	<0.2%				
Output Adjustment	4 turn potentiometer				
Circuit Protection	Short Circuit				
ENVIRONMENTAL					
Operating Temperature	0 to 50°C (32 to 122°F)				
Storage Temperature	0 to 70°C (32 to 158°F)				
Sealing	IP 65				
SPECIAL FEATURES					
Hold Input	Stops transmission and reception of sensor when input is connected to 0 VDC. Analog output would be zero VDC				
Synchronous Input	Avoids mutual interference from several ultrasonic sensors (external synchronization unit is required; see accessories)				
LED Indicator	Illuminates when sensor detects a target				

Ultrasonic Sensors

Precision Analog 18 mm Diameter

945 Series

WIRING DIAGRAMS

945-F/L, 945-E/G Series

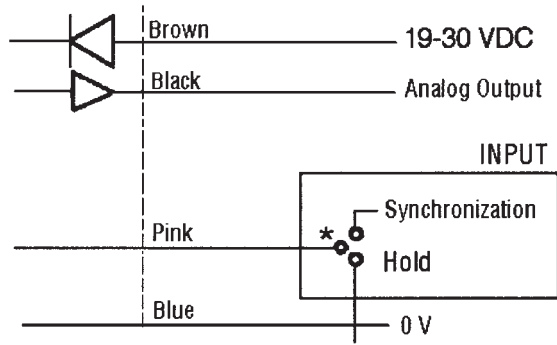

*Normal operation with connection to 19-30 VDC

MOUNTING DIMENSIONS (For reference only)

945-F/L Series Housing

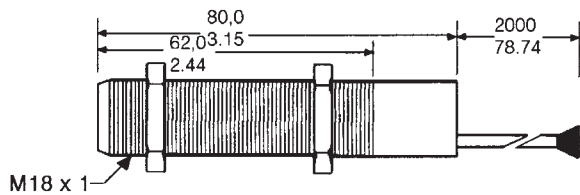

945-E/G Series with External Head

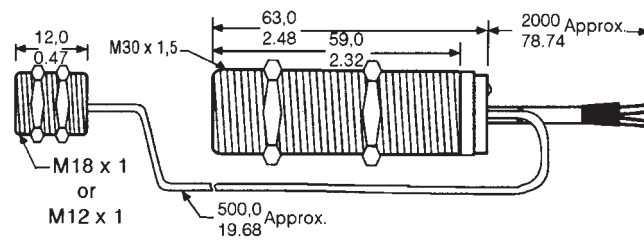

Proximity

ACCESSORIES

	Catalog Listing	Features
Synchronization unit	55000001	Controls up to 100 sensors
Mounting clamp, 18 mm housing	43178389-018	Allows mounting to flat surface
Beam deflector	43192871-003	Allows right angle mounting (approx. dim. 50 x 170 mm)
Focusing beam deflector	43192871-004	Reduces beam angle by approximately 50%

94X Series (942-04N-2D-1A1/1A2-80E, 943-04V-2D-001/002/1C0/1D0-80E, 947-04V-2D-1C0/1D0-80E)

Ultrasonic Distance Sensors



DESCRIPTION

This collection of ultrasonic devices offers enhanced sensing range capability in a square plastic housing. Available sensor types include programmable, Teach-In, and analogue and fixed output versions.

FEATURES

- Non contact distance sensing for use in non invasive measurement
- Reduced sensitivity to light intensity/reflectivity/opacity of target for enhanced flexibility and certainty of measurement
- Detects over much longer distance than other detection methods reducing the need for close proximity to the target
- Extremely long sensing distance (up to 6 m [19.65 ft]) reducing the need for close proximity measurement which can be critical for some applications

POTENTIAL APPLICATIONS

- Level measurement
- Presence/absence detection
- Distance measurement

943 Series (942-04N-2D-1A1/1A2-80E, 943-04V-2D-001/002/1C0/1D0-80E, 947-04V-2D-1C0/1D0-80E)

Specifications

Parameter	942-04N-2D-1A1-80E	942-04N-2D-1A2-80E	943-04V-2D-001-80E	943-04V-2D-002-80E	943-04V-2D-1C0-80E	943-04V-2D-1D0-80E	947-04V-2D-1C0-80E	947-04V-2D-1D0-80E
Max. sensing distance	6000 mm [236.22 in]						5000 mm [196.85 in]	
Min. sensing distance	600 mm [23.62 in]						500 mm [19.69 in]	
Expected response time 90% of final value	250 ms/prog		-		700 ms		400 ms	
Beam angle	8°						10°	
Switching frequency	7 Hz/prog		0.5 Hz		7 Hz/prog			
Linearity error	<0.3%		-		<0.5 %			
Hysteresis	prog		~1%		-			
Repeatability of measured distance	0.2%		-		0.2% ±2 mm [0.08 in]		0.2%	
Temperature range	-15 °C to 70 °C [-5 °F to 158 °F]							
Temperature compensation	yes						-	
Operating voltage	15 Vdc to 30 Vdc		12 Vdc to 30 Vdc		15 Vdc to 30 Vdc		24 Vdc ±20%	
Expected current consumption	100 mA		<80 mA		<35 mA		<40 mA	
Analogue output	0 V to 10 V/4 mA to 20 mA		-		0 V to 10 V 4 mA to 20 mA		0 V to 10 V 4 mA to 20 mA	
Analogue output selection by load	load >2 kOhm Uout load <500 Ohm Iout		-					
Switching outputs	2 PNP NO/NC 2 NPN NO/NC		2 PNP NO/NC 2 NPN NO/NC		-			
Expected output current	100 mA max.		500 mA max.		-			
Adjustment	programming				Teach-In			
Alignment LED			green (1)		-			
Status switching output 1			yellow (2)		-			
Status switching output 2			yellow (3)		-			
Control input			-					
Inhibit connect to:	Pin 6 → 0 V							
Synchronisation connect to:	Pin 6 ↔ Pin 6							
Enable connect to:	Pin 6 → NC							
Interface	RS232		-					
Plastic housing					PBPT			
Sealing*					IP65			
Connector	8 pin M16x0.75				5 pin M12x1			

*Attention! Do not expose sensor head to hot water >50 °C or steam vapour.

Accessories: 942-04N-2D-1A1/1A2-80E

Catalog Listing	Description
66195126-001	Mating connector straight
55000005-002	Programming adaptor
55000010-001	Software programming adaptor and PC connection cable
55000018-001	Programming cable

Accessories: 943-04V-2D-001/002-80E, 943-04V-2D-1C0/1D0-80E, 947-04V-2D-1C0/1D0-80E

Catalog Listing	Description
66195044-001	Mating connector straight
66195045-001	Mating connector angled
66195214-001	Straight cable/connector 2 m
66195216-001	Right-angle cable/connector 2 m

Ultrasonic Distance Sensors

Mounting Dimensions (For reference only. mm/[in])

942-O4N-2D-1A1/1A2-80E

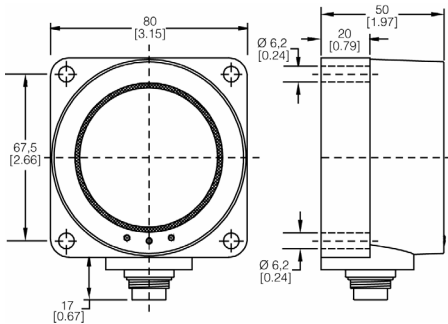

943-O4V-2D-001/002/1C0/1D0-80E,
947-O4V-2D-1C0/1D0-80E

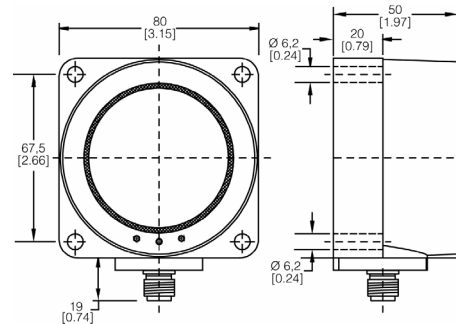

Wiring

P42-O4N-2D-1A1/1A2-80E

View to solder pins of connector

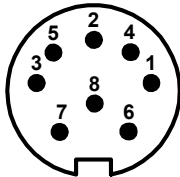

- Pin 1: + 24 Vdc
- Pin 2: GND
- Pin 3: U/I
- Pin 4: SP1
- Pin 5: SP2
- Pin 6: Hld/Sync
- Pin 7: Rx D
- Pin 8: Tx D

943-O4V-2D-001-80E

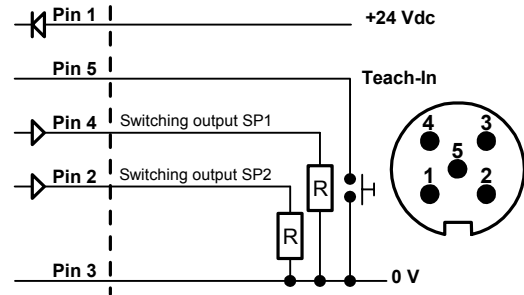

943-O4V-2D-002-80E

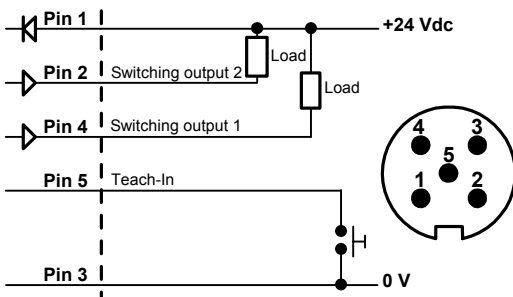

943-O4V-2D-1C0/1D0-80E

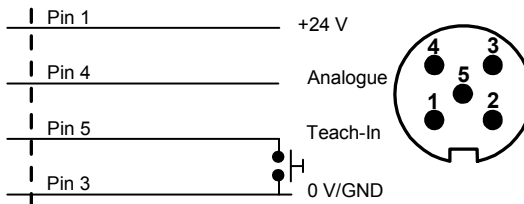

947-O4V-2D-1C0/1D0-80E

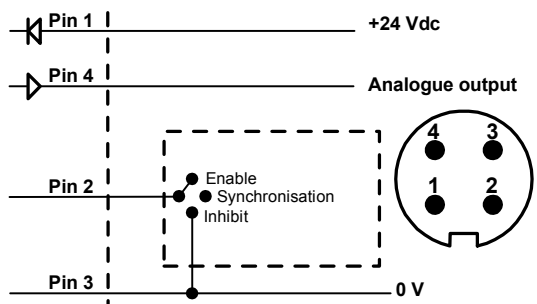

947-O4V-2D-1C0-80E

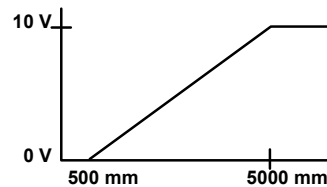

947-O4V-2D-1D0-80E

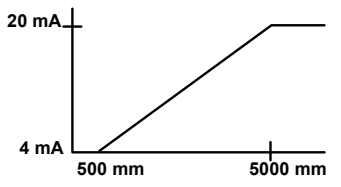

Detection Range

942-04N-2D-1A1/1A2-80E,
943-04V-2D-001/002/1C0/1D0-80E

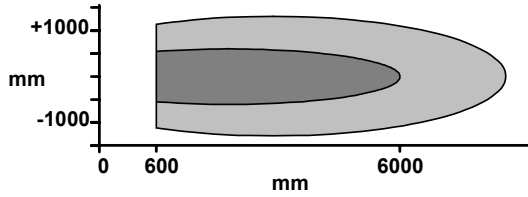

Enhanced detection of a target 100 mm² x 100 mm²
Possible detection of a large target

947-04V-2D-1C0/1D0-80E

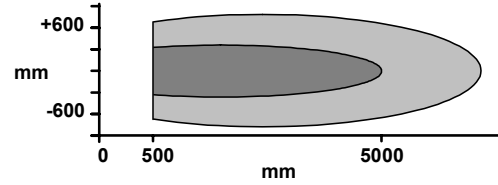

Enhanced detection of a target 100 mm² x 100 mm²
Possible detection of a large target

⚠ WARNING

PERSONAL INJURY

DO NOT USE these products as safety or emergency stop devices or in any other application where failure of the product could result in personal injury.

Failure to comply with these instructions could result in death or serious injury.

⚠ WARNING

MISUSE OF DOCUMENTATION

- The information presented in this product sheet is for reference only. Do not use this document as a product installation guide.
- Complete installation, operation, and maintenance information is provided in the instructions supplied with each product.

Failure to comply with these instructions could result in death or serious injury.

WARRANTY/REMEDY

Honeywell warrants goods of its manufacture as being free of defective materials and faulty workmanship. Honeywell's standard product warranty applies unless agreed to otherwise by Honeywell in writing; please refer to your order acknowledgement or consult your local sales office for specific warranty details. If warranted goods are returned to Honeywell during the period of coverage, Honeywell will repair or replace, at its option, without charge those items it finds defective. **The foregoing is buyer's sole remedy and is in lieu of all other warranties, expressed or implied, including those of merchantability and fitness for a particular purpose. In no event shall Honeywell be liable for consequential, special, or indirect damages.**

While we provide application assistance personally, through our literature and the Honeywell web site, it is up to the customer to determine the suitability of the product in the application.

Specifications may change without notice. The information we supply is believed to be accurate and reliable as of this printing. However, we assume no responsibility for its use.

SALES AND SERVICE

Honeywell serves its customers through a worldwide network of sales offices, representatives and distributors. For application assistance, current specifications, pricing or name of the nearest Authorized Distributor, contact your local sales office or:

E-mail: info.sc@honeywell.com

Internet: www.honeywell.com/sensing

Phone and Fax:

Asia Pacific +65 6355-2828
+65 6445-3033 Fax
Europe +44 (0) 1698 481481
+44 (0) 1698 481676 Fax
Latin America +1-305-805-8188
+1-305-883-8257 Fax
USA/Canada +1-800-537-6945
+1-815-235-6847
+1-815-235-6545 Fax

Automation and Control Solutions

Sensing and Control

Honeywell

1985 Douglas Drive North

Minneapolis, MN 55422

www.honeywell.com/sensing

004451-1-EN IL50 GLO Printed in USA
February 2006

Copyright © 2006 Honeywell International Inc. All rights reserved.

Honeywell

943 Series Ultrasonic Distance Sensors



The new 943 series industrial sensors are the latest addition to our product range. They have improved scanning ranges, remote teach in of the switching or analog outputs, as well as new advanced features, such as window and hysteresis modes.

OPTIONS AND ORDER GUIDE

2 switching outputs PNP NO and NPN NO

Beam angle: 8°
Supply voltage: 12 to 30 V
Sealing: IP67

Analogue voltage output 0-10 V and 4-20 mA

Beam angle: 8°
Supply voltage: 15 to 30 V
Sealing: IP67

M30

CONNECTOR

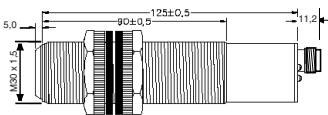

CABLE

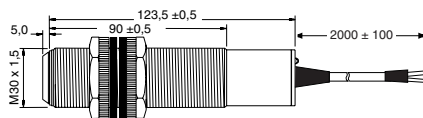

M30

Housing: M30 x 1,5 mm plastic (PBTB)
Max. sensing distance: 3500 mm
Min. sensing distance: 300 mm
Switching frequency: 1.0 Hz
Repeatability: 0,2 % or 2 mm

OUTPUT	TERMINATION	REFERENCE
PNP, 2 NO/NC	Connector	943-T4V-2D-001-130E
PNP, 2 NO/NC	Cable	943-T4V-2D-001-130E
NPN, 2 NO/NC	Connector	943-T4V-2D-002-130E
NPN, 2 NO/NC	Cable	943-T4V-2D-002-130E

M30

Housing: M30 x 1,5 mm plastic (PBTB)
Max. sensing distance: 3500 mm
Min. sensing distance: 300 mm
Response time: 400 ms
Repeatability: 0,2 % or ±2 mm

OUTPUT	TERMINATION	REFERENCE
0-10 V	Connector	943-T4V-2D-1C0-130E
0-10 V	Cable	943-T4V-2D-1C0-130E
4-10 mA	Connector	943-T4V-2D-1D0-130E
4-20 mA	Cable	943-T4V-2D-1D0-130E

M18

CONNECTOR

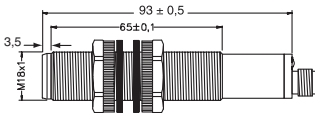

CABLE

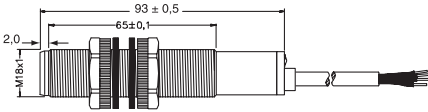

M18

Housing: M18 x 1,0 mm plastic (PBTB)
Max. sensing distance: 2000 mm
Min. sensing distance: 200 mm
Switching frequency: 1.2 Hz
Repeatability: 0,2 % or 2 mm

OUTPUT	TERMINATION	REFERENCE
PNP, 2 NO/NC	Connector	943-F4V-2D-001-180E
PNP, 2 NO/NC	Cable	943-F4V-2D-001-180E
NPN, 2 NO/NC	Connector	943-F4V-2D-002-180E
NPN, 2 NO/NC	Cable	943-F4V-2D-002-180E

M18

Housing: M18 x 1,0 mm plastic (PBTB)
Max. sensing distance: 2000 mm
Min. sensing distance: 200 mm
Switching frequency: 250 ms
Repeatability: 0,2 % or ±2 mm

OUTPUT	TERMINATION	REFERENCE
0-10 V	Connector	943-F4V-2D-1C0-180E
0-10 V	Cable	943-F4V-2D-1C0-180E
4-10 mA	Connector	943-F4V-2D-1D0-180E
4-20 mA	Cable	943-F4V-2D-1D0-180E

Max. sensing distance: 800 mm
Min. sensing distance: 100 mm
Switching frequency: 4.7 Hz
Repeatability: 0,2 % or 1 mm

OUTPUT	TERMINATION	REFERENCE
PNP, 2 NO/NC	Connector	943-F4V-2D-001-300E
PNP, 2 NO/NC	Cable	943-F4V-2D-001-300E
NPN, 2 NO/NC	Connector	943-F4V-2D-002-300E
NPN, 2 NO/NC	Cable	943-F4V-2D-002-300E

Max. sensing distance: 800 mm
Min. sensing distance: 100 mm
Switching frequency: 100 ms
Repeatability: 0,2 % or ±1 mm

OUTPUT	TERMINATION	REFERENCE
0-10 V	Connector	943-F4V-2D-1C0-300E
0-10 V	Cable	943-F4V-2D-1C0-300E
4-10 mA	Connector	943-F4V-2D-1D0-300E
4-20 mA	Cable	943-F4V-2D-1D0-300E

M18/M30

Termination: Connector M12 x 1
Cable Prelead 2 m

Max. sensing distance: 500 mm
Min. sensing distance: 60 mm
Switching frequency: 4.7 Hz
Repeatability: 0,2 % or 1 mm

OUTPUT	TERMINATION	REFERENCE
PNP, 2 NO/NC	Connector	943-F4V-2D-001-330E
PNP, 2 NO/NC	Cable	943-F4V-2D-001-330E
NPN, 2 NO/NC	Connector	943-F4V-2D-002-330E
NPN, 2 NO/NC	Cable	943-F4V-2D-002-330E

Max. sensing distance: 500 mm
Min. sensing distance: 60 mm
Switching frequency: 100 ms
Repeatability: 0,2 % or ±1 mm

OUTPUT	TERMINATION	REFERENCE
0-10 V	Connector	943-F4V-2D-1C0-330E
0-10 V	Cable	943-F4V-2D-1C0-330E
4-10 mA	Connector	943-F4V-2D-1D0-330E
4-20 mA	Cable	943-F4V-2D-1D0-330E

WARNING

MISUSE OF DOCUMENTATION

- The information presented in this product sheet (or catalogue) is for reference only. DO NOT USE this document as product installation information.
 - Complete installation, operation and maintenance information is provided in the instructions supplied with each product.
- Failure to comply with these instructions could result in death or serious injury.**

WARNING

PERSONAL INJURY

DO NOT USE these products as safety or emergency stop devices, or in any other application where failure of the product could result in personal injury.

Failure to comply with these instructions could result in death or serious injury.

Warranty/Remedy

Honeywell warrants goods of its manufacture as being free of defective material and faulty workmanship. Contact your local sales office for warranty information. If warranted goods are returned to Honeywell during that period of coverage, Honeywell will repair or replace without charge those items it finds defective. **The foregoing is Buyer's sole remedy and is in lieu of all other warranties, expressed or implied, including those of merchantability and fitness for a particular purpose.**

While we provide application assistance, personally, through our literature and the Honeywell web site, it is up to the customer to determine the suitability of the product in the application.

Specifications may change at any time without notice. The information we supply is believed to be accurate and reliable as of this printing. However, we assume no responsibility for its use.

Sales and Service

Honeywell serves its customers through a worldwide network of sales offices, representatives and distributors. For application assistance, current specifications, pricing or name of the nearest Authorised Distributor, contact your local sales office or:

INTERNET: www.honeywell.com/sensing

E-mail: info.sc@honeywell.com

ASIA PACIFIC

Control Products

Asia Pacific Headquarters

Phone: +(65) 6355-2828
FAX: +(65) 6445-3033

Australia

Honeywell Limited
Phone: +(61) 2-9370-4500
FAX: +(61) 2-9370-4525
Toll Free 1300-36-39-36
Toll Free Fax: 1300-36-04-70

China – PRC - Beijing

Honeywell China Inc.
Phone: +(86-10) 8458-3280
FAX: +(86-10) 8458-3102

China – PRC - Shanghai

Honeywell China Inc.
Phone: +(86-21) 6237-0237
FAX: +(86-21) 6237-1237

China - Hong Kong S.A.R.

Honeywell Ltd.
Phone: +(852) 2953-6412
FAX: +(852) 2953-6767

Indonesia

TATA Honeywell Indonesia Pte Ltd.
Phone: +(62) 21-535-8833
FAX: +(62) 21-5367 1008

India

TATA Honeywell Ltd.
Phone: +(91) 20 6870 445/446
FAX: +(91) 20 681 2243/ 687 5992

Japan

Honeywell Inc
Phone: +(81) 3 5440 1425
FAX: +(81) 3 5440 1368

South Korea

Honeywell Korea Co Ltd
Phone: +(822) 799-6167
FAX: +(822) 792-9013

Malaysia

Honeywell Engineering Sdn Bhd
Phone: +(60-3) 7958-4988
FAX: +(60-3) 7958-8922

New Zealand

Honeywell Limited
Phone: +(64-9) 623-5050
FAX: +(64-9) 623-5060
Toll Free (0800) 202-088

Philippines

Honeywell Systems
(Philippines) Inc.
Phone: +(63-2) 636-1661/1662
FAX: +(63-2) 638-4013

Singapore

Honeywell South East Asia
Phone: +(65) 6355-2828
FAX: +(65) 6445-3033

Thailand

Honeywell Systems (Thailand)
Ltd.
Phone: +(662) 693-3099
FAX: +(662) 693-3085

Taiwan R.O.C.

Honeywell Taiwan Ltd.
Phone: +(886-2) 2245-1000
FAX: +(886-2) 2245-3241

EUROPE

Austria

Honeywell Austria GmbH
Phone: +(43) 1 727 80 366/246
FAX: +(43) 1 727 80 337

Belgium

Honeywell SA/NV
Phone: +(32) 2 728 2522
FAX: +(32) 2 728 2502

Bulgaria

Honeywell EOOD
Phone: +(359) 2 979 00 23
FAX: +(359) 2 979 00 24

Czech Republic

Honeywell spol. s.r.o.
Phone: +(420) 242 442 111
FAX: +(420) 242 442 182

Denmark

Honeywell A/S
Phone: +(45) 39 55 55 55
FAX: +(45) 39 55 55 58

Finland

Honeywell OY
Phone: +(358) 9 3480101
FAX: +(358) 9 34801375

France

Honeywell SA
Phone: +(33) 1 60 19 80 40
FAX: +(33) 1 60 19 81 73

Germany

Honeywell AG
Phone: +(49) 69 8064 444
FAX: +(49) 69 8064 442

Hungary

Honeywell Kft.
Phone: +(361) 451 43 00
FAX: +(361) 451 43 43

Italy

Honeywell S.p.A.
Phone: +(39) 02 92146 450/456
FAX: +(39) 02 92146 490

The Netherlands

Honeywell B.V.
Phone: +(31) 20 565 69 11
FAX: +(31) 20 565 66 00

Norway

Honeywell A/S
Phone: +(47) 66 76 20 00
FAX: +(47) 66 76 20 90

Poland

Honeywell Sp. zo.o
Phone: +(48) 606 09 64
FAX: +(48) 606 09 01

Portugal

Honeywell Portugal Lda
Phone: +(351 21) 424 50 00
FAX: +(351 21) 424 50 99

Romania

Honeywell Bucharest
Phone: +(40) 21 231 64 37/38
FAX: +(40) 21 231 64 39

Commonwealth of Independent States (CIS)

Z.A.O. Honeywell
Phone: +(7 095) 796 98 36
FAX: +(7 095) 797 99 06

Slovak Republic

Honeywell s.r.o.
Phone: +(421 2) 58 247 403
FAX: +(421 2) 58 247 415

South Africa (Republic of)

Honeywell Southern Africa
Honeywell S.A. Pty. Ltd
Phone: +(27) 11 695 8000
FAX +(27) 11 805 1504

Spain

Honeywell S.A.
Phone: +(34) 91 313 6100
FAX: +(34) 91 313 6129

Sweden

Honeywell AB
Phone: +(46) 8 775 55 00
FAX: +(46) 8 775 56 00

Switzerland

Honeywell AG
Phone: +(41) 1 855 24 40
FAX: +(41) 1 855 24 45

Turkey

Honeywell Turkey A.S.
Phone: +(90) 216 5756620
FAX: +(90) 216 5756637

Ukraine

Honeywell
Phone: +(380) 44 201 44 74
FAX: +(380) 44 201 44 75

United Kingdom

Honeywell Control Systems
Ltd
Phone: +(44) 1698 481481
FAX: +(44) 1698 481676

Mediterranean & African Distributors

Honeywell SpA
Phone: +(39) 2 921 46 232
FAX: +(39) 2 921 46 233

Middle East Headquarters

Honeywell Middle East Ltd.
Phone: +(9712) 443 2119
FAX +(9712) 443 2536

NORTH AMERICA

USA/Canada

Honeywell
Sensing and Control
Phone: 1-800-537-6945
1-815-235-6847
FAX: 1-815-235-6545
E-mail:
info.sc@honeywell.com

LATIN AMERICA

Honeywell Latin America

Headquarters
Phone: 1-305-805-8188
FAX: 1-305-883-8257

Argentina

Honeywell S.A.I.C.
Phone: +(54-11) 4383-3627
FAX: +(54-11) 4325-6470

Brazil

Honeywell Do Brasil & Cia
Phone: +(55-11) 4166-1900
FAX: +(55-11) 4166-1901

Chile

Honeywell Chile, S.A.
Phone: +(56-2) 425-8400
FAX: +(56-2) 425-8410

Mexico

Honeywell S.A. de C.V.
Phone: +(52) 55 5081-0200
FAX: +(52) 55 5081-0202

Puerto Rico, Caribbean

Honeywell Inc.
Phone: +(787) 792-7075
FAX: +(787) 792-0053

Venezuela

Honeywell C.A.
Phone: +(58-212) 273-0511
FAX: +(58-212) 273-0599

This publication does not constitute a contract between Honeywell and its customers. The contents may be changed at any time without notice. It is the customer's responsibility to ensure safe installation and operation of the products. Detailed mounting drawings of all products illustrated are available on request. Copyright 2004 Honeywell International Inc. All Rights Reserved.

Honeywell

Sensing and Control

www.honeywell.com/sensing

Honeywell Control Systems Ltd
Newhouse Industrial Estate
Motherwell, Lanarkshire ML1 5SB
Scotland, UK

100464-EN Issue 1 02/04 UK07 GLO

943 Series (943-F4V/F4Y-2D-001/002/1C0/1D0-360E)

Ultrasonic Distance Sensors

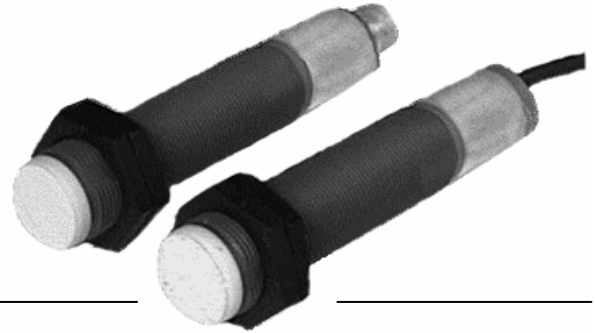

DESCRIPTION

The new 943-F4V (connector) and 943-F4Y (cable) Series industrial sensors are the latest additions to our range of ultrasonic distance sensors. They offer improved scanning ranges and remote Teach-In of the switching or analog outputs, in addition to new, advanced features, such as Window and Hysteresis modes. The devices are Teach-In compatible and have an M18 plastic housing.

FEATURES

- Non contact distance sensing for use in non invasive measurement
- Reduced sensitivity to light intensity/reflectivity/opacity of target for enhanced flexibility and certainty of measurement
- Detects over much longer distance than other detection methods reducing the need for close proximity to the target
- Presence absence, tank fill level and diameter measurement provides an extremely robust and flexible measurement method
- Short distance (in ultrasonic terms) for enhanced accuracy, repeatability (material independent) measurement to 30 mm [1.18 in].
-

POTENTIAL APPLICATIONS

- Reel diameter measurement
- Tank level measurement
- Presence/absence of an object
- Loop control
- Product height measurement
- Tire manufacturing

943 Series (943-F4V/F4Y-2D-001/002/1CO/1DO-360E)

Specifications

Parameter	943-F4V-2D-001-360E	943-F4V-2D-002-360E	943-F4V-2D-1CO-360E	943-F4V-2D-1DO-360E	943-F4Y-2D-001-360E	943-F4Y-2D-002-360E	943-F4Y-2D-1CO-360E	943-F4Y-2D-1DO-360E
Max. sensing distance	400 mm [15.75 in]							
Min. sensing distance	30 mm [1.18 in]							
Expected response time 90% of final value	-		60 ms		-		60 ms	
Beam angle	8°							
Switching frequency	15 Hz		-		15 Hz		-	
Linearity error	-		<0.5%		-		<0.5%	
Hysteresis	1%		-		1%		-	
Repeatability of measured distance	±1 mm [0.039 in] ±0.2%							
Temperature range	-15 °C to 70 °C [-5 °F to 158 °F]							
Temperature compensation	yes							
Operating voltage	12 Vdc to 30 Vdc		15 Vdc to 30 Vdc		12 Vdc to 30 Vdc		15 Vdc to 30 Vdc	
Possible min. supply	-		12 Vdc		-		12 Vdc	
Expected current consumption	<80 mA		<40 mA		<80 mA		<40 mA	
Output	2X PNP NO/NC	2X NPN NO/NC	0 V to 10 V	4 mA to 20 mA	2X PNP NO/NC	2X NPN NO/NC	0 V to 10 V	4 mA to 20 mA
Expected output current	500 mA max.		-		500 mA max.		-	
Adjustment set point	Teach-In		-		Teach-In		-	
Teach-In input	pin 5				pink wire			
Sensitivity	-		Teach-In		-		Teach-In	
Teach-In: P1/P2 determines output position	-		Teach-In		-		Teach-In	
Plastic housing	PBPT M18x1							
Sealing*	IP65							
Connector	M12x1				-			
Cable connection	-				2 m [6.56 ft]			

*Attention! Do not expose sensor head to hot water >50 °C or steam vapour.

Accessories: 943-F4V-2D-001/002/1CO/1DO-360E

Catalog Listing	Description
66195044-001	Mating connector straight
66195045-001	Mating connector angled
66195214-001	Straight cable/connector 2 m
66195216-001	Right-angle cable/connector 2 m
43178389-018	Mounting clamp
43192871-003	Beam deflector
43192871-004	Focusing beam deflector

Accessories: 943-F4Y-2D-001/002/1CO/1DO-360E

Catalog Listing	Description
43178389-018	Mounting clamp
43192871-003	Beam deflector
43192871-004	Focusing beam deflector

Ultrasonic Distance Sensors

Mounting Dimensions Continued (For reference only. mm/[in])

943-F4V-2D-001/002/1C0/1D0-360E

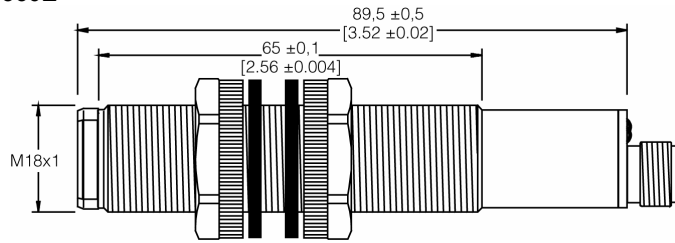

943-F4Y-2D-001/002/1C0/1D0-360E

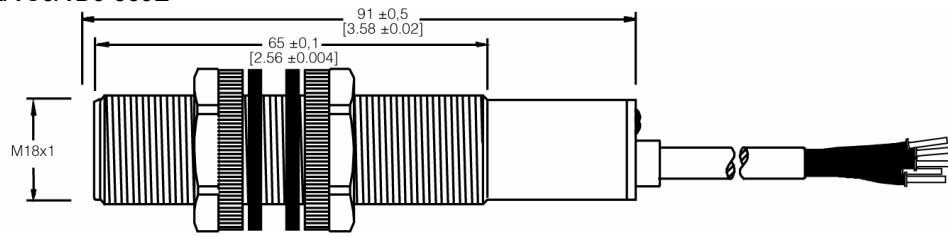

Wiring

943-F4V-2D-001-360E

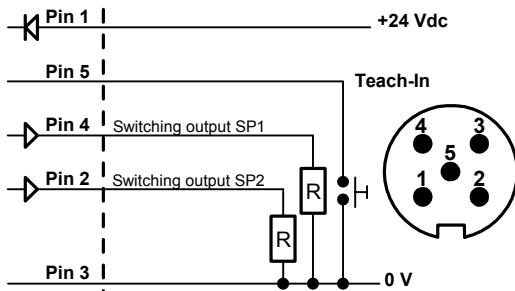

943-F4V-2D-002-360E

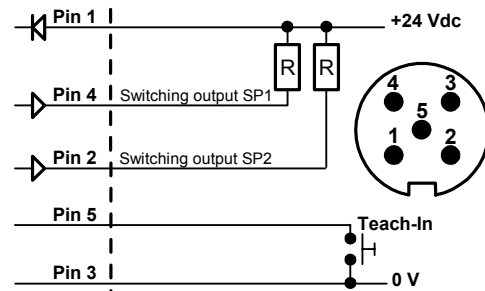

943-F4V-2D-1C0/1D0-360E

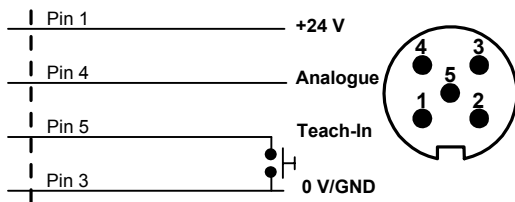

943-F4Y-2D-001/002-360E

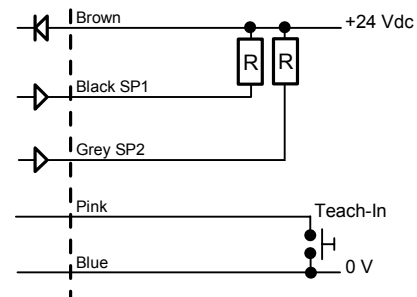

943-F4Y-2D-1C0/1D0-360E

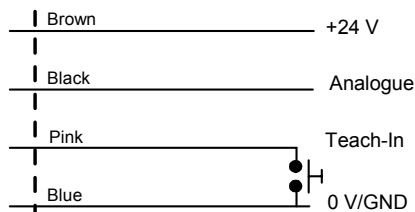

Detection Range

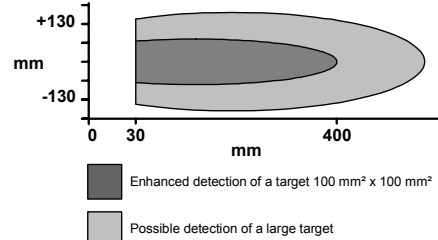

WARNING

PERSONAL INJURY

DO NOT USE these products as safety or emergency stop devices or in any other application where failure of the product could result in personal injury.

Failure to comply with these instructions could result in death or serious injury.

WARRANTY/REMEDY

Honeywell warrants goods of its manufacture as being free of defective materials and faulty workmanship. Honeywell's standard product warranty applies unless agreed to otherwise by Honeywell in writing; please refer to your order acknowledgement or consult your local sales office for specific warranty details. If warranted goods are returned to Honeywell during the period of coverage, Honeywell will repair or replace, at its option, without charge those items it finds defective. **The foregoing is buyer's sole remedy and is in lieu of all other warranties, expressed or implied, including those of merchantability and fitness for a particular purpose. In no event shall Honeywell be liable for consequential, special, or indirect damages.**

While we provide application assistance personally, through our literature and the Honeywell web site, it is up to the customer to determine the suitability of the product in the application.

Specifications may change without notice. The information we supply is believed to be accurate and reliable as of this printing. However, we assume no responsibility for its use.

WARNING

MISUSE OF DOCUMENTATION

- The information presented in this product sheet is for reference only. Do not use this document as a product installation guide.
- Complete installation, operation, and maintenance information is provided in the instructions supplied with each product.

Failure to comply with these instructions could result in death or serious injury.

SALES AND SERVICE

Honeywell serves its customers through a worldwide network of sales offices, representatives and distributors. For application assistance, current specifications, pricing or name of the nearest Authorized Distributor, contact your local sales office or:

E-mail: info.sc@honeywell.com

Internet: www.honeywell.com/sensing

Phone and Fax:

Asia Pacific	+65 6355-2828
	+65 6445-3033 Fax
Europe	+44 (0) 1698 481481
	+44 (0) 1698 481676 Fax
Latin America	+1-305-805-8188
	+1-305-883-8257 Fax
USA/Canada	+1-800-537-6945
	+1-815-235-6847
	+1-815-235-6545 Fax

Automation and Control Solutions

Sensing and Control

Honeywell

1985 Douglas Drive North

Minneapolis, MN 61032

www.honeywell.com/sensing

004452-1-1-EN IL50 GLO Printed in USA
February 2006

Copyright © 2006 Honeywell International Inc. All rights reserved.

Honeywell

943 Series (943-G4V-2G-001/002-400E)

Ultrasonic Distance Sensors



DESCRIPTION

The new 943-G4V series industrial sensors are the latest addition to our range of ultrasonic distance sensors. They offer improved scanning ranges and remote Teach-In of the switching or analogue outputs, in addition to new, advanced features, such as Window and Hysteresis modes. The devices are Teach-In compatible and have an M12 stainless steel housing for the 943 G4V.

FEATURES

- Non contact distance sensing for use in non invasive measurement
- Reduced sensitivity to light intensity/reflectivity/opacity of target for enhanced flexibility and certainty of measurement
- Detects over much longer distance than other detection methods reducing the need for close proximity to the target
- Short distance (in ultrasonic terms) for accuracy, repeatability (material independent) measurement to 25 mm [0.98 in].

POTENTIAL APPLICATIONS

- Reel diameter measurement
- Tank level measurement
- Presence/absence of an object
- Loop control
- Product height measurement
- Tire manufacturing

943 Series (943-G4V-2G-001/002-400E)

Specifications

Parameter	943-G4V-2G-001-400E	943-G4V-2G-002-400E
Max. sensing distance	250 mm [9.84 in]	
Min. sensing distance	25 mm [0.98 in]	
Switching frequency	30 Hz	
Hysteresis	1%	
Beam angle	8°	
Repeatability	0,3 mm [0.012 in]	
Temperature range	-20 °C to 70 °C [-4 °F to 158 °F]	
Operating voltage	10 Vdc to 30 Vdc	
Expected current consumption	<100 mA	
Output	PNP NO/NC	NPN NO/NC
Expected output current	100 mA max.	
Adjustment set point	Teach-In	
Stainless steel housing	M12x1	
Sealing*	IP65	
Connector	M12x1	

*Attention! Do not expose sensor head to hot water >50 °C or water vapour.

Accessories

Catalog Listing	Description
66195044-001	Mating connector straight
66195045-001	Mating connector angled

Mounting Dimensions (For reference only. mm/[in])

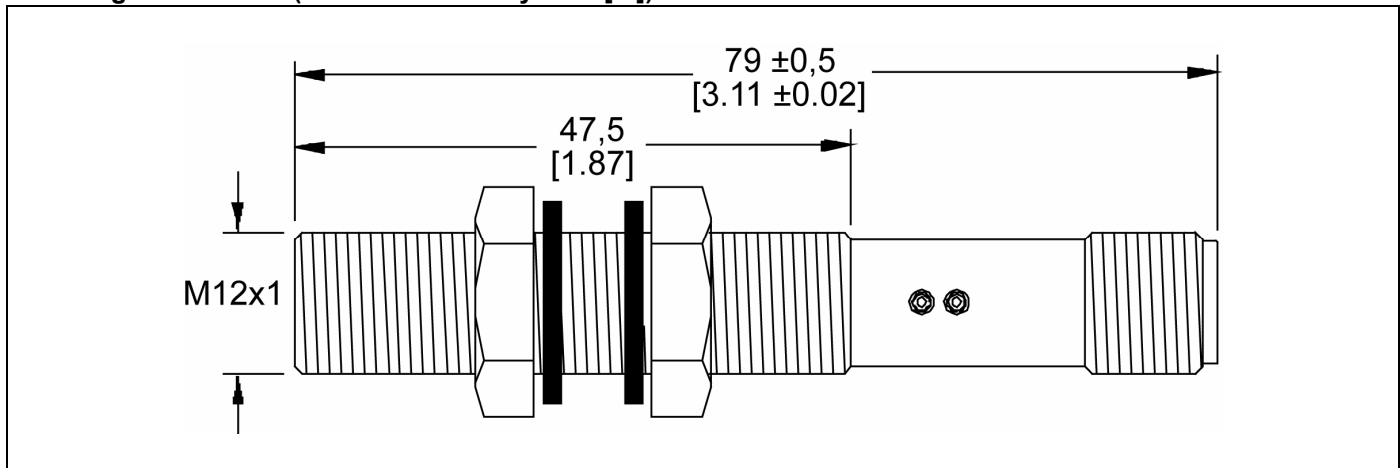

Ultrasonic Distance Sensors

Wiring

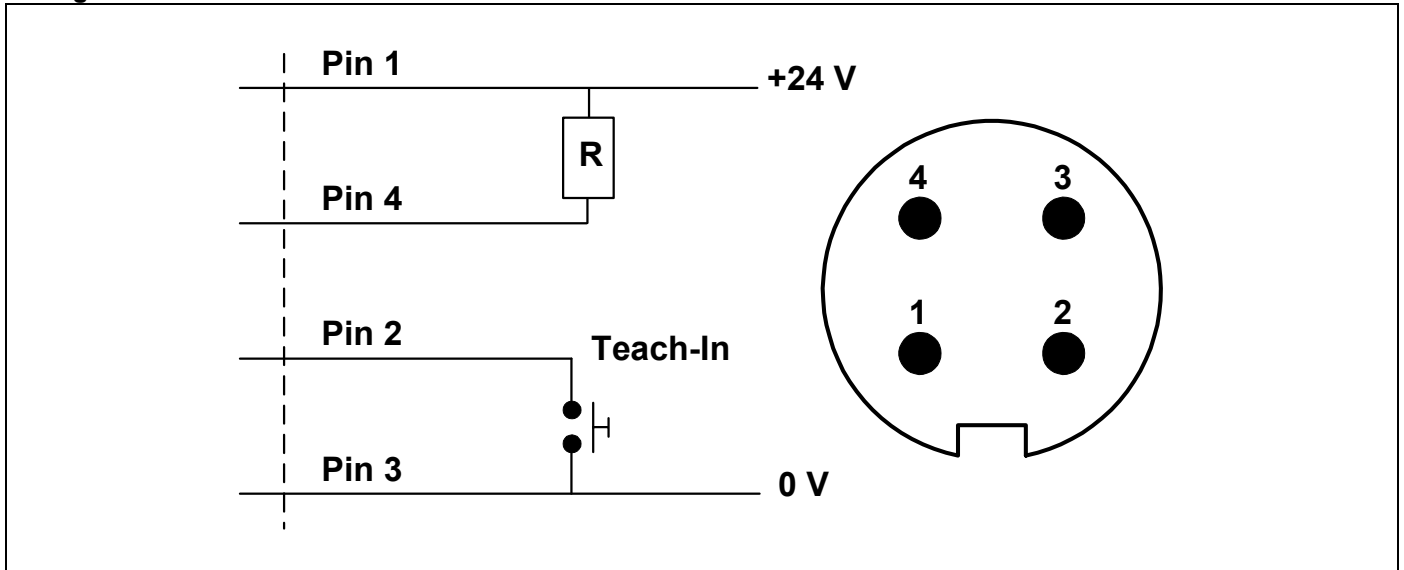

Detection Range

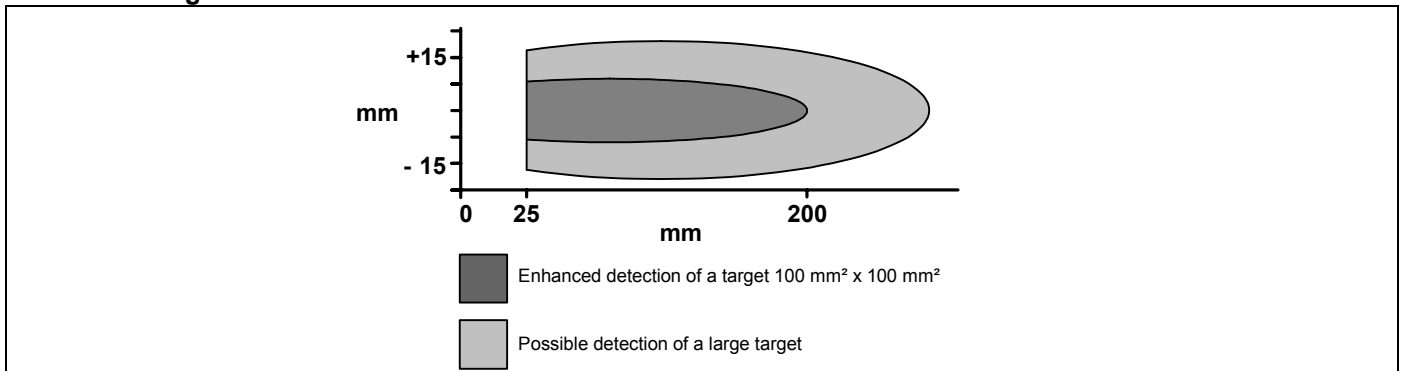

WARNING

PERSONAL INJURY

DO NOT USE these products as safety or emergency stop devices or in any other application where failure of the product could result in personal injury.

Failure to comply with these instructions could result in death or serious injury.

WARNING

MISUSE OF DOCUMENTATION

- The information presented in this product sheet is for reference only. Do not use this document as a product installation guide.
- Complete installation, operation, and maintenance information is provided in the instructions supplied with each product.

Failure to comply with these instructions could result in death or serious injury.

WARRANTY/REMEDY

Honeywell warrants goods of its manufacture as being free of defective materials and faulty workmanship. Honeywell's standard product warranty applies unless agreed to otherwise by Honeywell in writing; please refer to your order acknowledgement or consult your local sales office for specific warranty details. If warranted goods are returned to Honeywell during the period of coverage, Honeywell will repair or replace, at its option, without charge those items it finds defective. **The foregoing is buyer's sole remedy and is in lieu of all other warranties, expressed or implied, including those of merchantability and fitness for a particular purpose. In no event shall Honeywell be liable for consequential, special, or indirect damages.**

While we provide application assistance personally, through our literature and the Honeywell web site, it is up to the customer to determine the suitability of the product in the application.

Specifications may change without notice. The information we supply is believed to be accurate and reliable as of this printing. However, we assume no responsibility for its use.

SALES AND SERVICE

Honeywell serves its customers through a worldwide network of sales offices, representatives and distributors. For application assistance, current specifications, pricing or name of the nearest Authorized Distributor, contact your local sales office or:

E-mail: info.sc@honeywell.com

Internet: www.honeywell.com/sensing

Phone and Fax:

Asia Pacific	+65 6355-2828
	+65 6445-3033 Fax
Europe	+44 (0) 1698 481481
	+44 (0) 1698 481676 Fax
Latin America	+1-305-805-8188
	+1-305-883-8257 Fax
USA/Canada	+1-800-537-6945
	+1-815-235-6847
	+1-815-235-6545 Fax

Automation and Control Solutions

Sensing and Control

Honeywell

1985 Douglas Drive North

Minneapolis, MN 55422

www.honeywell.com/sensing

004449-1-EN IL50 GLO Printed in USA
February 2006
Copyright © 2006 Honeywell International Inc. All rights reserved.

Honeywell

943 Series (943-K4U-2G-001/002/1CO-400E) Ultrasonic Distance Sensors



DESCRIPTION

The new 943-K4U series industrial sensors are the latest addition to our range of ultrasonic distance sensors. They offer improved scanning ranges and remote Teach-In of the switching or analogue outputs, in addition to new, advanced features, such as Window and Hysteresis modes. The devices are Teach-In compatible and have a plastic housing.

FEATURES

- Non contact distance sensing for use in non invasive measurement
- Reduced sensitivity to light intensity/reflectivity/opacity of target for enhanced flexibility and certainty of measurement
- Detects over much longer distance than other detection methods reducing the need for close proximity to the target
- Presence absence, tank fill level and diameter measurement provide an extremely robust and flexible measurement method
- Miniature form factor device fits into the smallest mounting positions
- Two mounting methods provide flexibility of mounting options to suit the application

POTENTIAL APPLICATIONS

- Level measurement in small containers/test tubes
- Small object detection in narrow environments
- Presence detection
- Winding/unwinding control
- Height/thickness measurement
- Parts counting

Ultrasonic Distance Sensors

Wiring

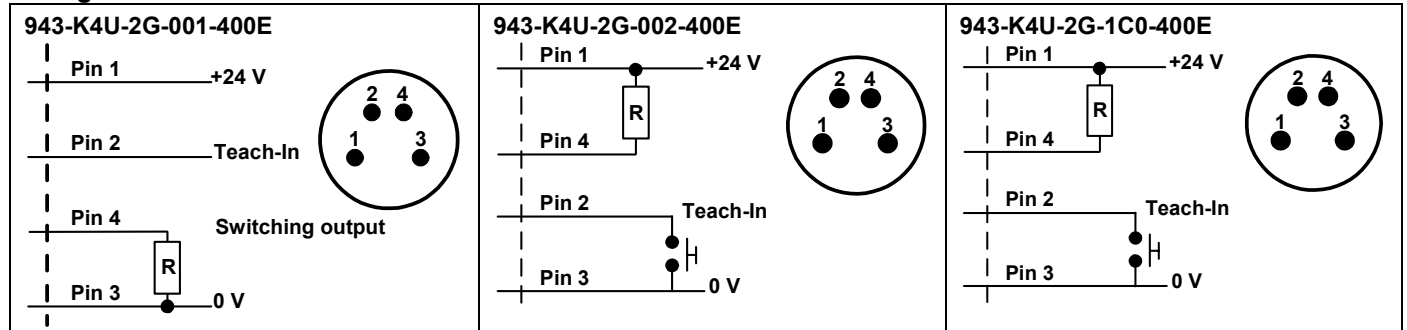

Detection Range

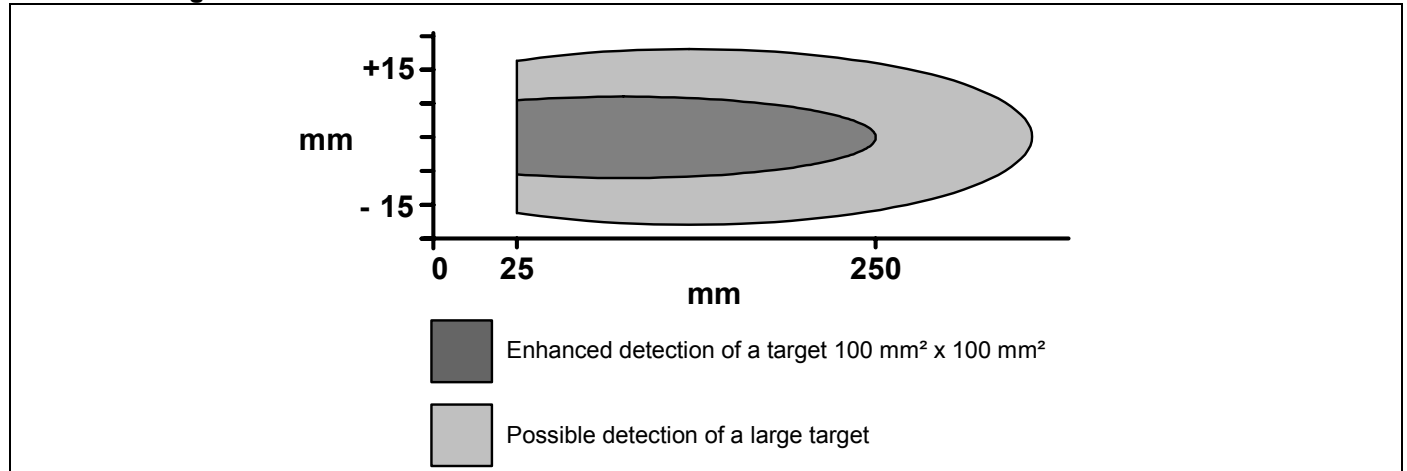

WARNING

PERSONAL INJURY

DO NOT USE these products as safety or emergency stop devices or in any other application where failure of the product could result in personal injury.

Failure to comply with these instructions could result in death or serious injury.

WARNING

MISUSE OF DOCUMENTATION

- The information presented in this product sheet is for reference only. Do not use this document as a product installation guide.
- Complete installation, operation, and maintenance information is provided in the instructions supplied with each product.

Failure to comply with these instructions could result in death or serious injury.

WARRANTY/REMEDY

Honeywell warrants goods of its manufacture as being free of defective materials and faulty workmanship. Honeywell's standard product warranty applies unless agreed to otherwise by Honeywell in writing; please refer to your order acknowledgement or consult your local sales office for specific warranty details. If warranted goods are returned to Honeywell during the period of coverage, Honeywell will repair or replace, at its option, without charge those items it finds defective. **The foregoing is buyer's sole remedy and is in lieu of all other warranties, expressed or implied, including those of merchantability and fitness for a particular purpose. In no event shall Honeywell be liable for consequential, special, or indirect damages.**

While we provide application assistance personally, through our literature and the Honeywell web site, it is up to the customer to determine the suitability of the product in the application.

Specifications may change without notice. The information we supply is believed to be accurate and reliable as of this printing. However, we assume no responsibility for its use.

SALES AND SERVICE

Honeywell serves its customers through a worldwide network of sales offices, representatives and distributors. For application assistance, current specifications, pricing or name of the nearest Authorized Distributor, contact your local sales office or:

E-mail: info.sc@honeywell.com

Internet: www.honeywell.com/sensing

Phone and Fax:

Asia Pacific	+65 6355-2828
	+65 6445-3033 Fax
Europe	+44 (0) 1698 481481
	+44 (0) 1698 481676 Fax
Latin America	+1-305-805-8188
	+1-305-883-8257 Fax
USA/Canada	+1-800-537-6945
	+1-815-235-6847
	+1-815-235-6545 Fax

Automation and Control Solutions

Sensing and Control

Honeywell

1985 Douglas Drive North

Minneapolis, MN 55422

www.honeywell.com/sensing

004450-1-EN IL50 GLO Printed in USA
February 2006

Copyright © 2006 Honeywell International Inc. All rights reserved.

Honeywell

948 Series (948-ISY-2D-001/002/003/004-180E)

Ultrasonic Distance Sensors

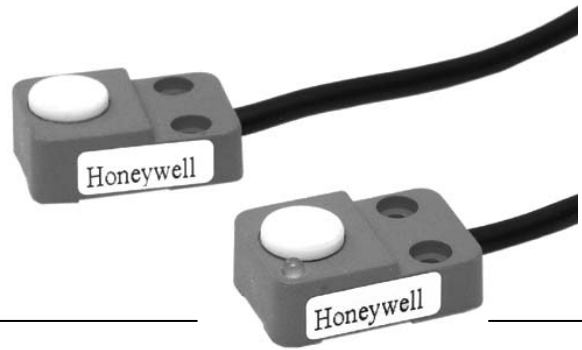

DESCRIPTION

The 948 Series is one of the smallest ultrasonic scan through devices in the world. Its small, rectangular, IP67-rated plastic housing makes it easy to install in limited space applications. The sensor consists of two parts, a transmitter and a receiver. It is especially suited for food and beverage applications, in particular bottle counting.

FEATURES

- Thru-scan detection regardless of the object material for enhanced detection
- Non contact distance sensing for use in non invasive measurement
- Reduced sensitivity to light intensity/reflectivity/opacity of target for enhanced flexibility and certainty of measurement
- Detects over much longer distance than other detection methods reducing the need for close proximity to the target
- Presence absence, tank fill level and diameter measurement provides an extremely robust and flexible measurement method

POTENTIAL APPLICATIONS

- Food and beverage machinery and equipment
- Rapid presence/absence detection: bottle counting
- Loop control

948 Series (948-ISY-2D-001/002/003/004-180E)

Specifications

Parameter	948-ISY-2D-001-180E	948-ISY-2D-002-180E	948-ISY-2D-003-180E	948-ISY-2D-004-180E
Sensing distance	1100 mm [3.61 ft]			
Response time on/off	3 ms			
Beam angle	15°			
Output	NO PNP	NO NPN	NC PNP	NC NPN
Expected output current	500 mA			
Switching frequency	150 Hz			
Temperature range	-15 °C to 60 °C [-5 °F to 140 °F]			
Operating voltage	18 Vdc to 30 Vdc			
Expected current consumption	<40 mA			
Housing	plastic			
Sealing	IP67			
Cable connection	2 m [6.56 ft]			

Sensor consists of 2 parts: 1 transmitter and 1 receiver.

With flat targets best results may be achieved with an angle 30° object-ultrasonic beam.

Ultrasonic Distance Sensors

Mounting Dimensions (For reference only. mm/[in])

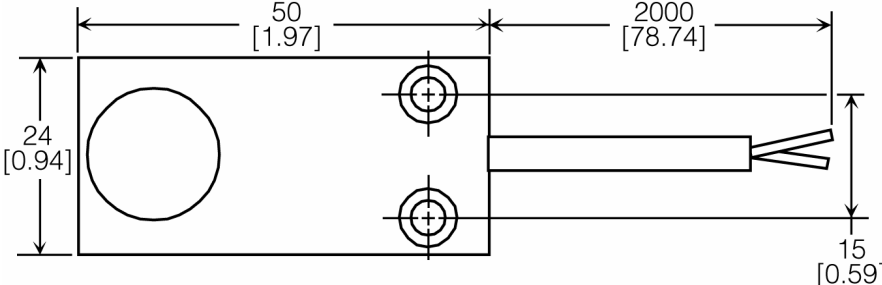
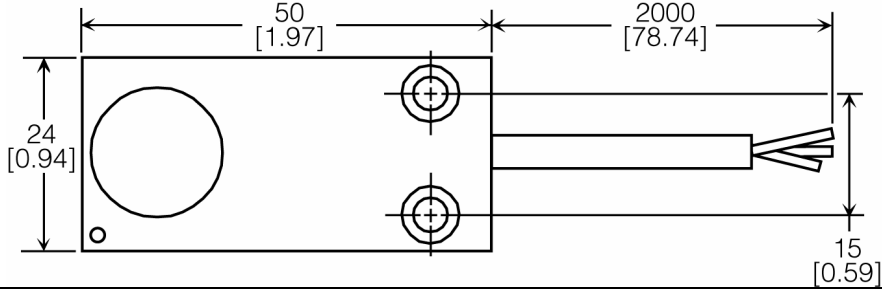
<p>Transmitter</p> 	<p>Brown: Vdc Blue: 0 V</p>
<p>Receiver</p> 	<p>Brown: Vdc Blue: 0 V Black: O/P</p>

WARNING

PERSONAL INJURY

DO NOT USE these products as safety or emergency stop devices or in any other application where failure of the product could result in personal injury.

Failure to comply with these instructions could result in death or serious injury.

WARRANTY/REMEDY

Honeywell warrants goods of its manufacture as being free of defective materials and faulty workmanship. Honeywell's standard product warranty applies unless agreed to otherwise by Honeywell in writing; please refer to your order acknowledgement or consult your local sales office for specific warranty details. If warranted goods are returned to Honeywell during the period of coverage, Honeywell will repair or replace, at its option, without charge those items it finds defective. **The foregoing is buyer's sole remedy and is in lieu of all other warranties, expressed or implied, including those of merchantability and fitness for a particular purpose. In no event shall Honeywell be liable for consequential, special, or indirect damages.**

While we provide application assistance personally, through our literature and the Honeywell web site, it is up to the customer to determine the suitability of the product in the application.

Specifications may change without notice. The information we supply is believed to be accurate and reliable as of this printing. However, we assume no responsibility for its use.

Automation and Control Solutions

Sensing and Control

Honeywell

1985 Douglas Drive North

Minneapolis, MN 55422

www.honeywell.com/sensing

004448-1-EN IL50 GLO Printed in USA
February 2006

Copyright © 2006 Honeywell International Inc. All rights reserved.

WARNING

MISUSE OF DOCUMENTATION

- The information presented in this product sheet is for reference only. Do not use this document as a product installation guide.
- Complete installation, operation, and maintenance information is provided in the instructions supplied with each product.

Failure to comply with these instructions could result in death or serious injury.

SALES AND SERVICE

Honeywell serves its customers through a worldwide network of sales offices, representatives and distributors. For application assistance, current specifications, pricing or name of the nearest Authorized Distributor, contact your local sales office or:

E-mail: info.sc@honeywell.com

Internet: www.honeywell.com/sensing

Phone and Fax:

Asia Pacific +65 6355-2828

+65 6445-3033 Fax

Europe +44 (0) 1698 481481

+44 (0) 1698 481676 Fax

Latin America +1-305-805-8188

+1-305-883-8257 Fax

USA/Canada +1-800-537-6945

+1-815-235-6847

+1-815-235-6545 Fax

Honeywell

Looking for pricing, stock, or lifecycle information?

Click below to explore more details on WIN SOURCE:

 [View SCN-1461SC on WIN SOURCE](#)

 [Honeywell Information](#)

Optimize Your Supply Chain with WIN SOURCE Solutions

-  Global Sourcing Solution
-  Obsolete Management
-  Cost Control Management
-  Shortage Management
-  Alternative Solution
-  Excess Inventory Management