



**THE DATASHEET OF
SD02H0SBDR**



SD Series Low Profile DIP Switches



H
DIP

Features/Benefits

- Low profile design saves space
- Thru-hole and surface mount models
- Tape and reel packaging available
- Sealed with top tape
- RoHS compliant

Typical Applications

- Address switch for industrial controls
- Logic switching for computers and peripherals
- Function controlling for numerous applications



Specifications

SWITCH FUNCTION: SPST - 2, 3, 4, 5, 6, 7, 8, 9, 10 & 12 positions

CONTACT RATING:

Carry: 100 mA @ 50 V DC max.

Switch: 0.1 mA @ 5 V DC min to 100 mA @ 25 V DC max.

MECHANICAL AND ELECTRICAL LIFE: 2,000 make-and-break cycles at full load, each circuit.

CONTACT RESISTANCE: Below 50 milliohms typ. initial @ 2-4 V DC, 100mA.

INSULATION RESISTANCE: 10⁹ ohms min.

DIELECTRIC STRENGTH: 500 V RMS min. @ sea level between adjacent terminals.

STORAGE TEMPERATURE: -40°C to 85°C.

OPERATING TEMPERATURE: -40°C to 85°C.

OPERATING FORCE: 100-700g initial.

PACKAGING: Thru-hole switches supplied in rigid dispensing tubes in full-tube quantities only; this may effect order quantity. Surface mount switches available in tape and reel packaging by added 'R' to end of part number; 1,000 pieces per reel. Switch position 1 denotes pin number 1. All switch actuators in 'OFF' position, standard.

Materials

CASE & COVER: (PPA), flame retardant (UL 94V-0)

ACTUATOR: Nylon, flame retardant (UL 94V-0)

CONTACTS: BeCu with gold plate.

TERMINALS: Bright tin-plated brass.

TERMINAL SEAL: All terminals insert molded.

TAPE SEAL: Polyimide.

Note: Specifications and materials listed above are for switches with standard options. For information on specific and custom switches, consult Customer Service Center.

How To Order

The Build-A Switch concept allows you to mix and match options to create the switch you need. Below is a complete listing of options shown in catalog. To order, simply select desired option from each category and place in the appropriate box.

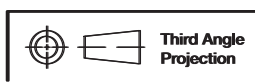

Dimensions are shown: Inch (mm)
Specifications and dimensions subject to change



9 January 2018

SD Series Low Profile DIP Switches

DIP H

Sealed Flush Actuator – With Top Tape, Thru-hole Terminals

Process sealed - withstands soldering and cleaning processes



| ROHS PART NUMBER | NO. POS. | DIM. 'A' | QUANTITY PER TUBE |
|------------------|----------|---------------|-------------------|
| SD02H0B | 2 | .258 (6,55) | 85 |
| SD03H0B | 3 | .358 (9,09) | 60 |
| SD04H0B | 4 | .458 (11,63) | 45 |
| SD05H0B | 5 | .558 (14,17) | 40 |
| SD06H0B | 6 | .658 (16,71) | 30 |
| SD07H0B | 7 | .758 (19,25) | 25 |
| SD08H0B | 8 | .858 (21,79) | 25 |
| SD09H0B | 9 | .958 (24,33) | 20 |
| SD10H0B | 10 | 1.058 (26,87) | 20 |
| SD12H0B | 12 | 1.258 (31,95) | 15 |



Table applicable to "H0" and "H2" actuator options.

Sealed Flush Actuator – With Top Tape, Surface Mount Terminals

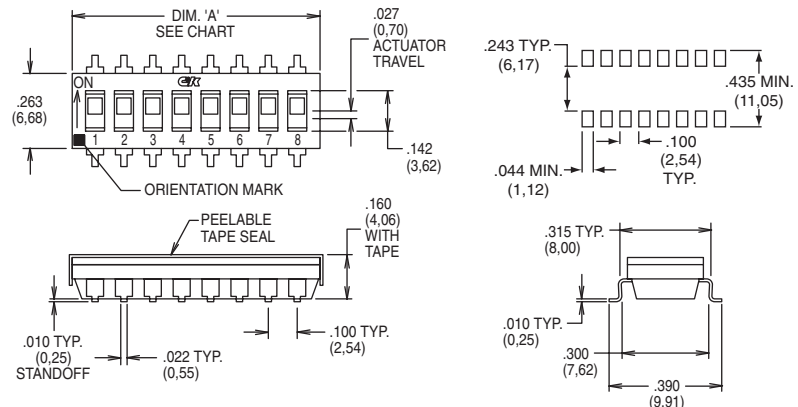

| RoHS PART NUMBER | NO. POS. | DIM. 'A' | QUANTITY PER TUBE |
|------------------|----------|---------------|-------------------|
| SD02H0SB | 2 | .258 (6,55) | 85 |
| SD03H0SB | 3 | .358 (9,09) | 60 |
| SD04H0SB | 4 | .458 (11,63) | 45 |
| SD05H0SB | 5 | .558 (14,17) | 40 |
| SD06H0SB | 6 | .658 (16,71) | 30 |
| SD07H0SB | 7 | .758 (19,25) | 25 |
| SD08H0SB | 8 | .858 (21,79) | 25 |
| SD09H0SB | 9 | .958 (24,33) | 20 |
| SD10H0SB | 10 | 1.058 (26,87) | 20 |
| SD12H0SB | 12 | 1.258 (31,95) | 15 |

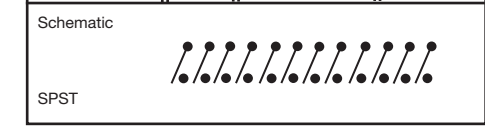
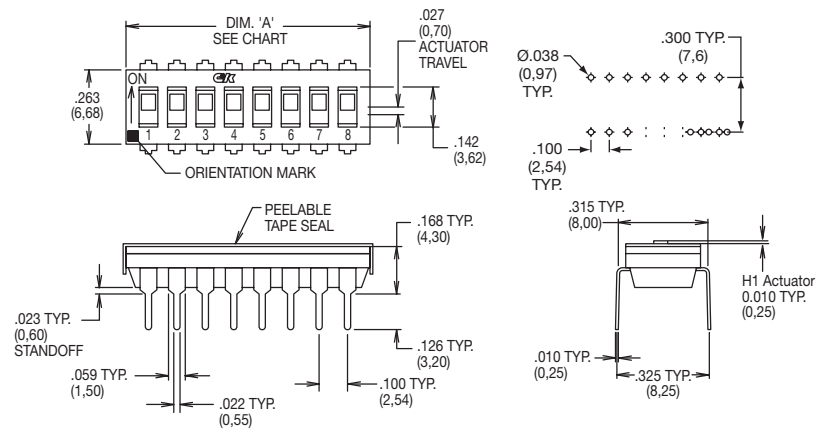

Table applicable to "H0" and "H2" actuator options.

Sealed Extended Actuator – With Top Tape, Thru-hole Terminals



| RoHS PART NUMBER | NO. POS. | DIM. 'A' | QUANTITY PER TUBE |
|------------------|----------|---------------|-------------------|
| SD02H1B | 2 | .258 (6,55) | 85 |
| SD03H1B | 3 | .358 (9,09) | 60 |
| SD04H1B | 4 | .458 (11,63) | 45 |
| SD05H1B | 5 | .558 (14,17) | 40 |
| SD06H1B | 6 | .658 (16,71) | 30 |
| SD07H1B | 7 | .758 (19,25) | 25 |
| SD08H1B | 8 | .858 (21,79) | 25 |
| SD09H1B | 9 | .958 (24,33) | 20 |
| SD10H1B | 10 | 1.058 (26,87) | 20 |
| SD12H1B | 12 | 1.258 (31,95) | 15 |



Table applicable to "H1" and "H3" actuator options.



9 January 2018

Dimensions are shown: Inch (mm)
Specifications and dimensions subject to change

SD Series Low Profile DIP Switches

H DIP

Sealed Extended Actuator – With Top Tape, Surface Mount Terminals

| RoHS PART NUMBER | NO. POS. | DIM. 'A' | QUANTITY PER TUBE |
|------------------|----------|---------------|-------------------|
| SD02H1SB | 2 | .258 (6,55) | 85 |
| SD03H1SB | 3 | .358 (9,09) | 60 |
| SD04H1SB | 4 | .458 (11,63) | 45 |
| SD05H1SB | 5 | .558 (14,17) | 40 |
| SD06H1SB | 6 | .658 (16,71) | 30 |
| SD07H1SB | 7 | .758 (19,25) | 25 |
| SD08H1SB | 8 | .858 (21,79) | 25 |
| SD09H1SB | 9 | .958 (24,33) | 20 |
| SD10H1SB | 10 | 1.058 (26,87) | 20 |
| SD12H1SB | 12 | 1.258 (31,95) | 15 |

Schematic

SPST

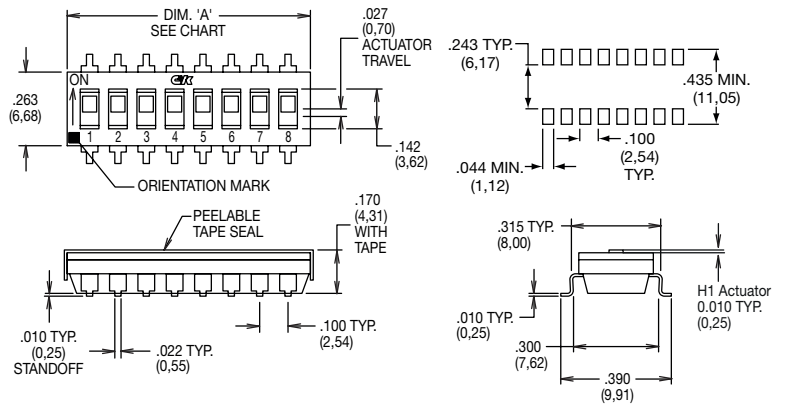

Table applicable to "H1" and "H3" actuator options.

TAPE & REEL PACKAGING – SURFACE MOUNT OPTIONS ONLY

| RoHS PART NUMBER | NO. POS. | DIM. 'A' | QUANTITY PER REEL |
|------------------|----------|---------------|-------------------|
| SD02H0SBR | 2 | .258 (6,55) | 1000 |
| SD03H0SBR | 3 | .358 (9,09) | 1000 |
| SD04H0SBR | 4 | .458 (11,63) | 1000 |
| SD05H0SBR | 5 | .558 (14,17) | 1000 |
| SD06H0SBR | 6 | .658 (16,71) | 1000 |
| SD07H0SBR | 7 | .758 (19,25) | 1000 |
| SD08H0SBR | 8 | .858 (21,79) | 1000 |
| SD09H0SBR | 9 | .958 (24,33) | 1000 |
| SD10H0SBR | 10 | 1.058 (26,87) | 1000 |
| SD12H0SBR | 12 | 1.258 (31,95) | 1000 |

Schematic

SPST

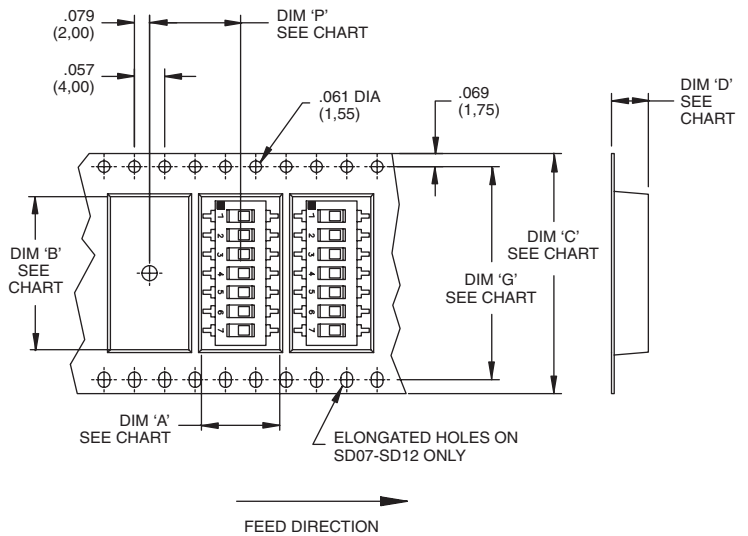
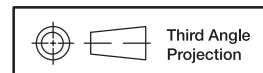

Table applicable to "H0" and "H2" actuator options.

| SWITCH NO. | DIM 'A' POCKET LENGTH @ BOTTOM | DIM 'B' POCKET LENGTH @ BOTTOM | DIM 'C' TAPE WIDTH | DIM 'D' POCKET DEPTH | DIM 'G' SPROCKET HOLE SPACING | DIM 'P' PITCH BETWEEN POCKETS |
|------------|--------------------------------|--------------------------------|--------------------|----------------------|-------------------------------|-------------------------------|
| SD02 | .413(10,5) | .315(8,0) | .630(16,0) | .177(4,5) | N/A | .472(12,0) |
| SD03 | .406(10,3) | .406(10,3) | .630(16,0) | .177(4,5) | N/A | .472(12,0) |
| SD04 | .429(10,9) | .476(12,1) | .954(24,0) | .177(4,5) | N/A | .472(12,0) |
| SD05 | .406(10,3) | .602(15,3) | .954(24,0) | .177(4,5) | N/A | .472(12,0) |
| SD06 | .406(10,3) | .701(17,8) | .954(24,0) | .177(4,5) | N/A | .472(12,0) |
| SD07 | .406(10,3) | .803(20,4) | 1.260(32,0) | .177(4,5) | 1.118(28,4) | .472(12,0) |
| SD08 | .406(10,3) | .854(21,7) | 1.732(44,0) | .177(4,5) | 1.591(40,4) | .472(12,0) |
| SD09 | .406(10,3) | 1.028(26,1) | 1.732(44,0) | .177(4,5) | 1.591(40,4) | .472(12,0) |
| SD10 | .406(10,3) | 1.055(26,8) | 1.732(44,0) | .177(4,5) | 1.591(40,4) | .472(12,0) |
| SD12 | .406(10,3) | 1.303(33,1) | 1.732(44,0) | .177(4,5) | 1.591(40,4) | .472(12,0) |

Reel Information

Outside diameter 13.00 (333,0)
Pilot hole .512 (13,0)



Dimensions are shown: Inch (mm)
Specifications and dimensions subject to change



9 January 2018

Looking for pricing, stock, or lifecycle information?

Click below to explore more details on WIN SOURCE:

- ⊖ [View SD02H0SBDR](#) on WIN SOURCE
- ⊖ [C&K Components](#) Information

Optimize Your Supply Chain with WIN SOURCE Solutions

- ✓ Global Sourcing Solution
- ✓ Obsolete Management
- ✓ Cost Control Management
- ✓ Shortage Management
- ✓ Alternative Solution
- ✓ Excess Inventory Management