



**THE DATASHEET OF  
SD06H1SB**



# SD Series Low Profile DIP Switches



H  
DIP

## Features/Benefits

- Low profile design saves space
- Thru-hole and surface mount models
- Tape and reel packaging available
- Sealed with top tape
- RoHS compliant

## Typical Applications

- Address switch for industrial controls
- Logic switching for computers and peripherals
- Function controlling for numerous applications



## Specifications

SWITCH FUNCTION: SPST - 2, 3, 4, 5, 6, 7, 8, 9, 10 & 12 positions

CONTACT RATING:

Carry: 100 mA @ 50 V DC max.

Switch: 0.1 mA @ 5 V DC min to 100 mA @ 25 V DC max.

MECHANICAL AND ELECTRICAL LIFE: 2,000 make-and-break cycles at full load, each circuit.

CONTACT RESISTANCE: Below 50 milliohms typ. initial @ 2-4 V DC, 100mA.

INSULATION RESISTANCE: 10<sup>9</sup> ohms min.

DIELECTRIC STRENGTH: 500 V RMS min. @ sea level between adjacent terminals.

STORAGE TEMPERATURE: -40°C to 85°C.

OPERATING TEMPERATURE: -40°C to 85°C.

OPERATING FORCE: 100-700g initial.

PACKAGING: Thru-hole switches supplied in rigid dispensing tubes in full-tube quantities only; this may effect order quantity. Surface mount switches available in tape and reel packaging by added 'R' to end of part number; 1,000 pieces per reel. Switch position 1 denotes pin number 1. All switch actuators in 'OFF' position, standard.

## Materials

CASE & COVER: (PPA), flame retardant (UL 94V-0)

ACTUATOR: Nylon, flame retardant (UL 94V-0)

CONTACTS: BeCu with gold plate.

TERMINALS: Bright tin-plated brass.

TERMINAL SEAL: All terminals insert molded.

TAPE SEAL: Polyimide.

**Note:** Specifications and materials listed above are for switches with standard options. For information on specific and custom switches, consult Customer Service Center.

## How To Order

The Build-A Switch concept allows you to mix and match options to create the switch you need. Below is a complete listing of options shown in catalog. To order, simply select desired option from each category and place in the appropriate box.

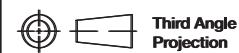

Dimensions are shown: Inch (mm)  
Specifications and dimensions subject to change



9 January 2018

# SD Series Low Profile DIP Switches

DIP H

## Sealed Flush Actuator – With Top Tape, Thru-hole Terminals

Process sealed - withstands soldering and cleaning processes



ROHS PART NUMBER	NO. POS.	DIM. 'A'	QUANTITY PER TUBE
<b>SD02H0B</b>	2	.258 (6,55)	85
<b>SD03H0B</b>	3	.358 (9,09)	60
<b>SD04H0B</b>	4	.458 (11,63)	45
<b>SD05H0B</b>	5	.558 (14,17)	40
<b>SD06H0B</b>	6	.658 (16,71)	30
<b>SD07H0B</b>	7	.758 (19,25)	25
<b>SD08H0B</b>	8	.858 (21,79)	25
<b>SD09H0B</b>	9	.958 (24,33)	20
<b>SD10H0B</b>	10	1.058 (26,87)	20
<b>SD12H0B</b>	12	1.258 (31,95)	15

Schematic



SPST

Table applicable to "H0" and "H2" actuator options.

## Sealed Flush Actuator – With Top Tape, Surface Mount Terminals

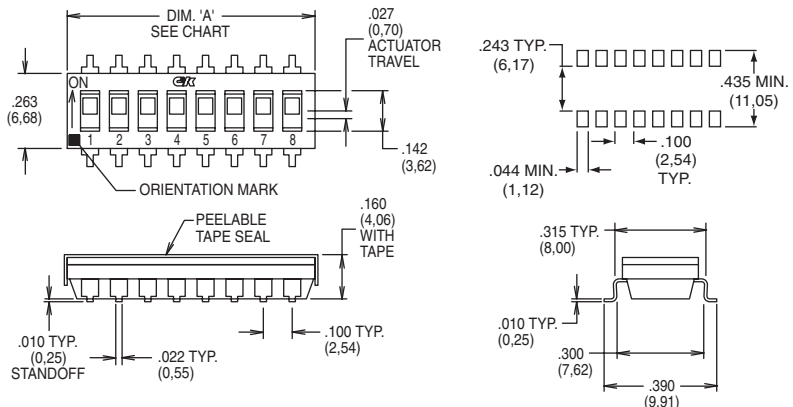

RoHS PART NUMBER	NO. POS.	DIM. 'A'	QUANTITY PER TUBE
<b>SD02H0SB</b>	2	.258 (6,55)	85
<b>SD03H0SB</b>	3	.358 (9,09)	60
<b>SD04H0SB</b>	4	.458 (11,63)	45
<b>SD05H0SB</b>	5	.558 (14,17)	40
<b>SD06H0SB</b>	6	.658 (16,71)	30
<b>SD07H0SB</b>	7	.758 (19,25)	25
<b>SD08H0SB</b>	8	.858 (21,79)	25
<b>SD09H0SB</b>	9	.958 (24,33)	20
<b>SD10H0SB</b>	10	1.058 (26,87)	20
<b>SD12H0SB</b>	12	1.258 (31,95)	15

Schematic



SPST

Table applicable to "H0" and "H2" actuator options.

## Sealed Extended Actuator – With Top Tape, Thru-hole Terminals

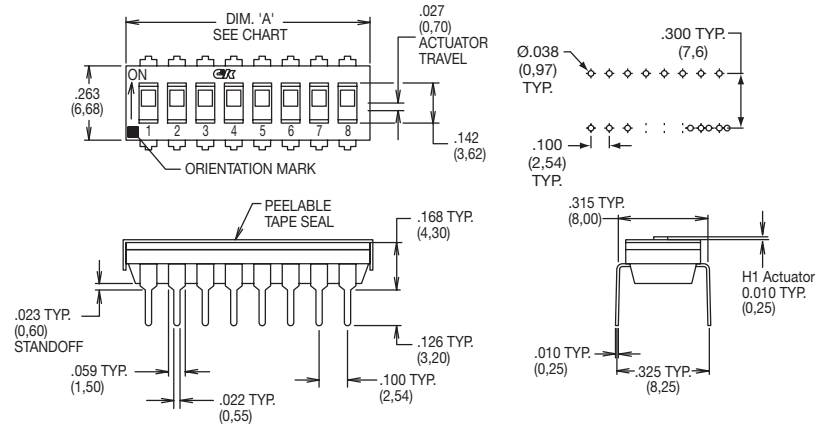

RoHS PART NUMBER	NO. POS.	DIM. 'A'	QUANTITY PER TUBE
<b>SD02H1B</b>	2	.258 (6,55)	85
<b>SD03H1B</b>	3	.358 (9,09)	60
<b>SD04H1B</b>	4	.458 (11,63)	45
<b>SD05H1B</b>	5	.558 (14,17)	40
<b>SD06H1B</b>	6	.658 (16,71)	30
<b>SD07H1B</b>	7	.758 (19,25)	25
<b>SD08H1B</b>	8	.858 (21,79)	25
<b>SD09H1B</b>	9	.958 (24,33)	20
<b>SD10H1B</b>	10	1.058 (26,87)	20
<b>SD12H1B</b>	12	1.258 (31,95)	15

Schematic



SPST

Table applicable to "H1" and "H3" actuator options.



Third Angle Projection  
Dimensions are shown: Inch (mm)  
Specifications and dimensions subject to change



9 January 2018

# SD Series Low Profile DIP Switches

H DIP

## Sealed Extended Actuator – With Top Tape, Surface Mount Terminals

RoHS PART NUMBER	NO. POS.	DIM. 'A'	QUANTITY PER TUBE
<b>SD02H1SB</b>	2	.258 (6,55)	85
<b>SD03H1SB</b>	3	.358 (9,09)	60
<b>SD04H1SB</b>	4	.458 (11,63)	45
<b>SD05H1SB</b>	5	.558 (14,17)	40
<b>SD06H1SB</b>	6	.658 (16,71)	30
<b>SD07H1SB</b>	7	.758 (19,25)	25
<b>SD08H1SB</b>	8	.858 (21,79)	25
<b>SD09H1SB</b>	9	.958 (24,33)	20
<b>SD10H1SB</b>	10	1.058 (26,87)	20
<b>SD12H1SB</b>	12	1.258 (31,95)	15

Schematic

SPST

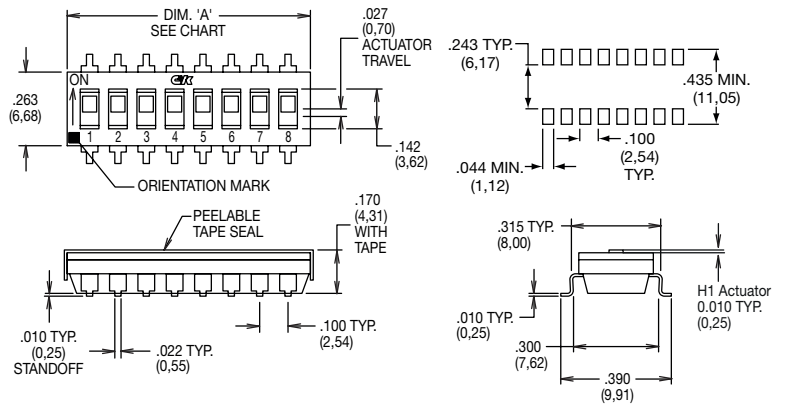

Table applicable to "H1" and "H3" actuator options.

## TAPE & REEL PACKAGING – SURFACE MOUNT OPTIONS ONLY

RoHS PART NUMBER	NO. POS.	DIM. 'A'	QUANTITY PER REEL
<b>SD02H0SBR</b>	2	.258 (6,55)	1000
<b>SD03H0SBR</b>	3	.358 (9,09)	1000
<b>SD04H0SBR</b>	4	.458 (11,63)	1000
<b>SD05H0SBR</b>	5	.558 (14,17)	1000
<b>SD06H0SBR</b>	6	.658 (16,71)	1000
<b>SD07H0SBR</b>	7	.758 (19,25)	1000
<b>SD08H0SBR</b>	8	.858 (21,79)	1000
<b>SD09H0SBR</b>	9	.958 (24,33)	1000
<b>SD10H0SBR</b>	10	1.058 (26,87)	1000
<b>SD12H0SBR</b>	12	1.258 (31,95)	1000

Schematic

SPST

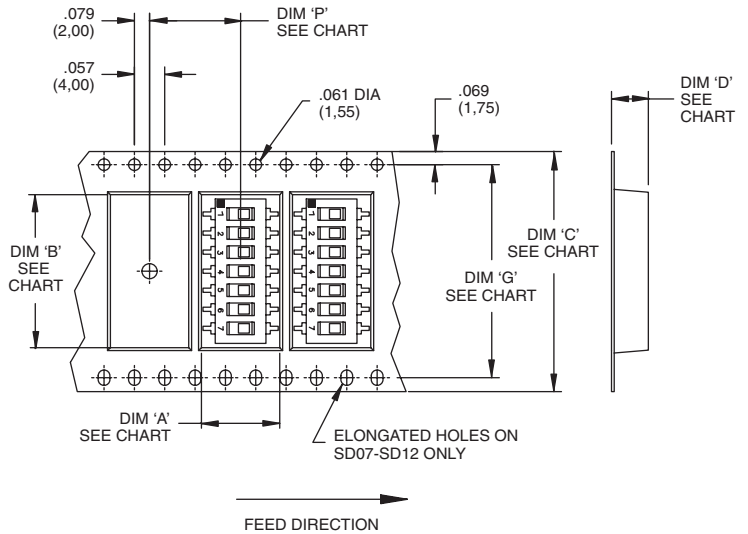
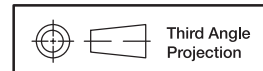

Table applicable to "H0" and "H2" actuator options.

SWITCH NO.	DIM 'A' POCKET LENGTH @ BOTTOM	DIM 'B' POCKET LENGTH @ BOTTOM	DIM 'C' TAPE WIDTH	DIM 'D' POCKET DEPTH	DIM 'G' SPROCKET HOLE SPACING	DIM 'P' PITCH BETWEEN POCKETS
SD02	.413(10,5)	.315(8,0)	.630(16,0)	.177(4,5)	N/A	.472(12,0)
SD03	.406(10,3)	.406(10,3)	.630(16,0)	.177(4,5)	N/A	.472(12,0)
SD04	.429(10,9)	.476(12,1)	.954(24,0)	.177(4,5)	N/A	.472(12,0)
SD05	.406(10,3)	.602(15,3)	.954(24,0)	.177(4,5)	N/A	.472(12,0)
SD06	.406(10,3)	.701(17,8)	.954(24,0)	.177(4,5)	N/A	.472(12,0)
SD07	.406(10,3)	.803(20,4)	1.260(32,0)	.177(4,5)	1.118(28,4)	.472(12,0)
SD08	.406(10,3)	.854(21,7)	1.732(44,0)	.177(4,5)	1.591(40,4)	.472(12,0)
SD09	.406(10,3)	1.028(26,1)	1.732(44,0)	.177(4,5)	1.591(40,4)	.472(12,0)
SD10	.406(10,3)	1.055(26,8)	1.732(44,0)	.177(4,5)	1.591(40,4)	.472(12,0)
SD12	.406(10,3)	1.303(33,1)	1.732(44,0)	.177(4,5)	1.591(40,4)	.472(12,0)

### Reel Information

Outside diameter 13.00 (333,0)  
Pilot hole .512 (13,0)





Dimensions are shown: Inch (mm)  
Specifications and dimensions subject to change



9 January 2018

## Looking for pricing, stock, or lifecycle information?

Click below to explore more details on WIN SOURCE:

-  [View SD06H1SB](#) on WIN SOURCE
-  [C&K Components](#) Information

## Optimize Your Supply Chain with WIN SOURCE Solutions

-  Global Sourcing Solution
-  Obsolete Management
-  Cost Control Management
-  Shortage Management
-  Alternative Solution
-  Excess Inventory Management