



**THE DATASHEET OF  
SDA10H0SB**



# SDA Series Low Profile DIP Switches



H

DIP

## Features/Benefits

- Low profile design saves space
- Thru-hole and surface mount models
- Tape and reel packaging available
- RoHS compliant

## Typical Applications

- Address switch for industrial controls
- Logic switching for computers and peripherals
- Function controlling for numerous applications



## Specifications

CONTACT RATING: 25 mA @ 24 V DC or 100 mA @ 5 V DC.  
 MECHANICAL AND ELECTRICAL LIFE: 1,000 cycles at rated loads.  
 CONTACT RESISTANCE: 50 mΩ max. initial.  
 INSULATION RESISTANCE: 100 MΩ between terminals.  
 DIELECTRIC WITHSTANDING VOLTAGE: 300 V DC min. for 1 minute.  
 STORAGE TEMPERATURE: -40°C to 85°C.  
 OPERATING TEMPERATURE: -40°C to 85°C.  
 OPERATING FORCE: 800 grams max.  
 SOLDERABILITY: Dip and look solderability testing per C&K spec. #448. Unplated edges of terminals permitted.  
 PACKAGING: Switches supplied in rigid dispensing tubes in full-tube quantities only, this may affect order quantity. Numbers of switches per tube varies with model. Tape and reel pack-

aging also available for surface mount options.

## Materials

HOUSING: PPS, color black (UL94V-0).  
 COVER: PPS, color black (UL94V-0).  
 ACTUATOR: PA6T (UL94-0)  
 CONTACTS: Gold plated Beryllium copper.  
 TERMINALS: Gold plate over nickel plated brass.  
 TAPE SEAL: Polyimide.

**Note:** Specifications and materials listed above are for switches with standard options. For information on specific and custom switches, consult Customer Service Center. For Tin Lead options consult customer service center.

## How To Order

The Build-A Switch concept allows you to mix and match options to create the switch you need. Below is a complete listing of options shown in catalog. To order, simply select desired option from each category and place in the appropriate box.

All switches supplied in "OFF" position.

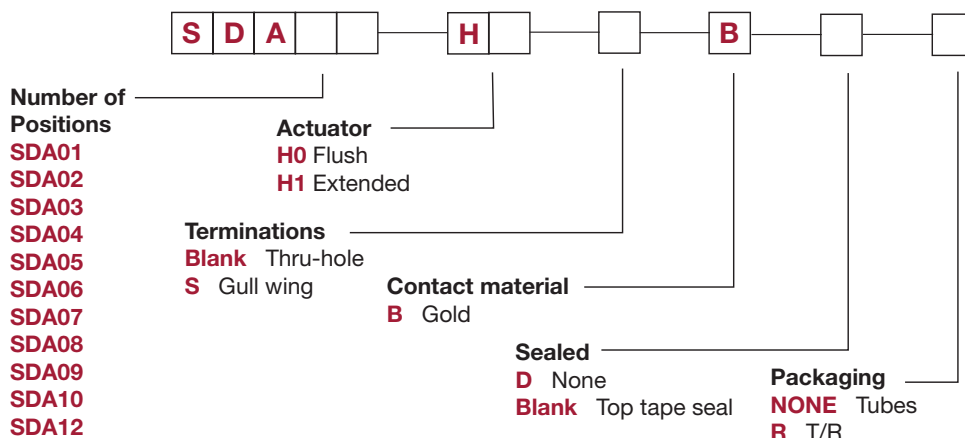

Dimensions are shown: Inch (mm)  
 Specifications and dimensions subject to change

# SDA Series Low Profile DIP Switches



DIP H

## Flush Actuator – No Tape, Thru-hole Terminals



SDA08H0BD



NOTE: SDA 01 options are 4,25mm thick

ROHS PART NUMBER	NO. POS.	DIM. 'A'	QUANTITY PER TUBE
<b>SDA01H0BD</b>	1	.178 (4,52)	100
<b>SDA02H0BD</b>	2	.278 (7,06)	60
<b>SDA03H0BD</b>	3	.378 (9,60)	45
<b>SDA04H0BD</b>	4	.476 (12,10)	35
<b>SDA05H0BD</b>	5	.578 (14,68)	30
<b>SDA06H0BD</b>	6	.676 (17,18)	25
<b>SDA07H0BD</b>	7	.778 (19,76)	20
<b>SDA08H0BD</b>	8	.876 (22,26)	20
<b>SDA09H0BD</b>	9	.978 (24,84)	15
<b>SDA10H0BD</b>	10	1.076 (27,34)	15
<b>SDA12H0BD</b>	12	1.279 (32,50)	14

Schematic

SPST

## Flush Actuator – With Top Tape, Thru-hole Terminals



SDA08H0B



NOTE: SDA 01 options are 4,25mm thick

ROHS PART NUMBER	NO. POS.	DIM. 'A'	QUANTITY PER TUBE
<b>SDA01H0B</b>	1	.178 (4,52)	100
<b>SDA02H0B</b>	2	.278 (7,06)	60
<b>SDA03H0B</b>	3	.378 (9,60)	45
<b>SDA04H0B</b>	4	.476 (12,10)	35
<b>SDA05H0B</b>	5	.578 (14,68)	30
<b>SDA06H0B</b>	6	.676 (17,18)	25
<b>SDA07H0B</b>	7	.778 (19,76)	20
<b>SDA08H0B</b>	8	.876 (22,26)	20
<b>SDA09H0B</b>	9	.978 (24,84)	15
<b>SDA10H0B</b>	10	1.076 (27,34)	15
<b>SDA12H0B</b>	12	1.279 (32,50)	14

Schematic

SPST



Dimensions are shown: Inch (mm)  
Specifications and dimensions subject to change

# SDA Series Low Profile DIP Switches



H  
DIP

## Flush Actuator – With Top Tape, Surface Mount Terminals

ROHS PART NUMBER	NO. POS.	DIM. 'A'	QUANTITY PER TUBE
<b>SDA01H0SB</b>	1	.178 (4,52)	100
<b>SDA02H0SB</b>	2	.278 (7,06)	60
<b>SDA03H0SB</b>	3	.378 (9,60)	45
<b>SDA04H0SB</b>	4	.476 (12,10)	35
<b>SDA05H0SB</b>	5	.578 (14,68)	30
<b>SDA06H0SB</b>	6	.676 (17,18)	25
<b>SDA07H0SB</b>	7	.778 (19,76)	20
<b>SDA08H0SB</b>	8	.876 (22,26)	20
<b>SDA09H0SB</b>	9	.978 (24,84)	15
<b>SDA10H0SB</b>	10	1.076 (27,34)	15
<b>SDA12H0SB</b>	12	1.279 (32,50)	14

Schematic

SPST



SDA08H0SB

NOTE: SDA 01 options are 4,25mm thick

## Flush Actuator – No Tape, Surface Mount Terminals

ROHS PART NUMBER	NO. POS.	DIM. 'A'	QUANTITY PER TUBE
<b>SDA01H0SBD</b>	1	.178 (4,52)	100
<b>SDA02H0SBD</b>	2	.278 (7,06)	60
<b>SDA03H0SBD</b>	3	.378 (9,60)	45
<b>SDA04H0SBD</b>	4	.476 (12,10)	35
<b>SDA05H0SBD</b>	5	.578 (14,68)	30
<b>SDA06H0SBD</b>	6	.676 (17,18)	25
<b>SDA07H0SBD</b>	7	.778 (19,76)	20
<b>SDA08H0SBD</b>	8	.876 (22,26)	20
<b>SDA09H0SBD</b>	9	.978 (24,84)	15
<b>SDA10H0SBD</b>	10	1.076 (27,34)	15
<b>SDA12H0SBD</b>	12	1.279 (32,50)	14

Schematic

SPST



SDA08H0SBD

NOTE: SDA 01 options are 4,25mm thick

## Extended Actuator – No Top Tape, Thru-hole Terminals

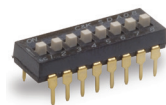

SDA08H1BD

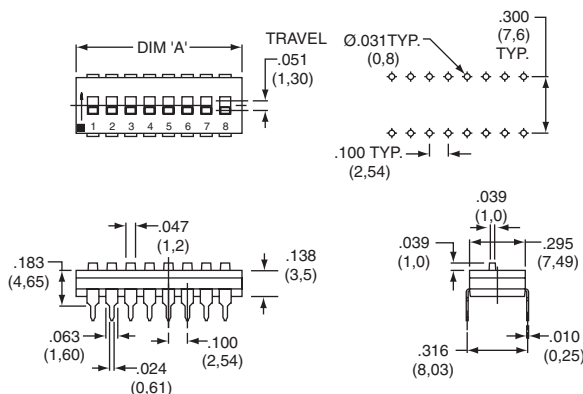

NOTE: SDA 01 options are 4,25mm thick

ROHS PART NUMBER	NO. POS.	DIM. 'A'	QUANTITY PER TUBE
<b>SDA01H1BD</b>	1	.178 (4,52)	100
<b>SDA02H1BD</b>	2	.278 (7,06)	60
<b>SDA03H1BD</b>	3	.378 (9,60)	45
<b>SDA04H1BD</b>	4	.476 (12,10)	35
<b>SDA05H1BD</b>	5	.578 (14,68)	30
<b>SDA06H1BD</b>	6	.676 (17,18)	25
<b>SDA07H1BD</b>	7	.778 (19,76)	20
<b>SDA08H1BD</b>	8	.876 (22,26)	20
<b>SDA09H1BD</b>	9	.978 (24,84)	15
<b>SDA10H1BD</b>	10	1.076 (27,34)	15
<b>SDA12H1BD</b>	12	1.279 (32,50)	14

Schematic

SPST



Dimensions are shown: Inch (mm)  
Specifications and dimensions subject to change



# SDA Series Low Profile DIP Switches

## Extended Actuator – No Top Tape, Surface Mount Terminals



SDA08H1SBD



NOTE: SDA 01 options are 4,25mm thick

ROHS PART NUMBER	NO. POS.	DIM. 'A'	QUANTITY PER TUBE
<b>SDA01H1SBD</b>	1	.178 (4,52)	100
<b>SDA02H1SBD</b>	2	.278 (7,06)	60
<b>SDA03H1SBD</b>	3	.378 (9,60)	45
<b>SDA04H1SBD</b>	4	.476 (12,10)	35
<b>SDA05H1SBD</b>	5	.578 (14,68)	30
<b>SDA06H1SBD</b>	6	.676 (17,18)	25
<b>SDA07H1SBD</b>	7	.778 (19,76)	20
<b>SDA08H1SBD</b>	8	.876 (22,26)	20
<b>SDA09H1SBD</b>	9	.978 (24,84)	15
<b>SDA10H1SBD</b>	10	1.076 (27,34)	15
<b>SDA12H1SBD</b>	12	1.279 (32,50)	14

Schematic  
SPST

## Tape & Reel Packaging – Surface Mount Options only

MODEL NO. 'S' OPTION	DIM. 'H' (REF.)	DIM. 'W1' (REF.)	DIM. 'W2' (REF.)	DIM. 'B' (REF.)	DIM. 'C' (REF.)	DIM. 'D' (REF.)	QUANTITY PER REEL
SDA01	H0	5.2	24.0	24.4	8.5	11.5	1500
	H1	5.8					1450
SDA02	H0	4.8	24.0	24.4	7.9	11.5	750
	H1	5.8					700
SDA03	H0	4.8	24.0	24.4	10.4	11.5	750
	H1	5.8					700
SDA04	H0	4.8	24.0	24.4	12.9	11.5	750
	H1	5.8					700
SDA05	H0	4.8	24.0	24.4	15.4	11.5	750
	H1	5.8					700
SDA06	H0	4.8	32.0	32.4	18.0	14.2	750
	H1	5.8					700
SDA07	H0	4.8	32.0	32.4	20.5	14.2	750
	H1						NOT CURRENTLY AVAILABLE IN TAPE AND REEL
SDA08	H0	4.8	44.0	44.4	22.7	20.2	750
	H1	5.8					700
SDA09	H0	4.8	44.0	44.4	25.5	20.2	750
	H1	5.8					700
SDA10	H0	4.8	44.0	44.0	28.1	20.2	750
	H1	5.8					700
SDA12	H0	4.8	44.0	44.4	33.2	20.2	750
	H1						NOT CURRENTLY AVAILABLE IN TAPE AND REEL

SDA01H1SBD OPTION SHOWN

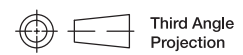
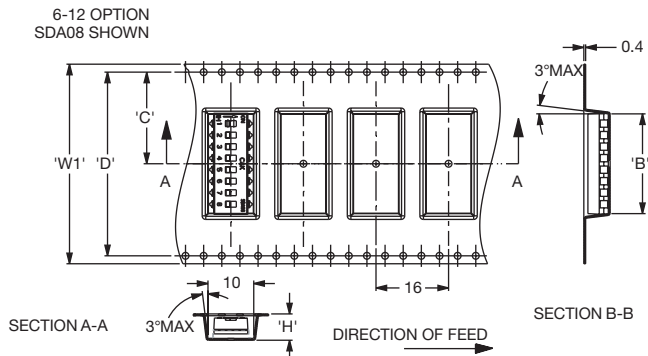
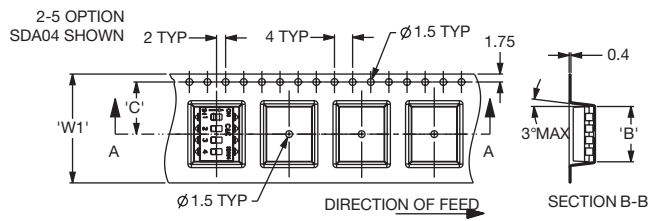
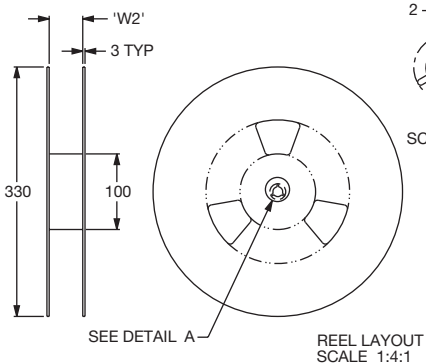
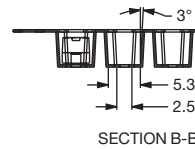

Dimensions are shown: Inch (mm)  
Specifications and dimensions subject to change

## Looking for pricing, stock, or lifecycle information?

Click below to explore more details on WIN SOURCE:

- ⊖ [View SDA10H0SB](#) on WIN SOURCE
- ⊖ [C&K Components](#) Information

## Optimize Your Supply Chain with WIN SOURCE Solutions

- ✓ Global Sourcing Solution
- ✓ Obsolete Management
- ✓ Cost Control Management
- ✓ Shortage Management
- ✓ Alternative Solution
- ✓ Excess Inventory Management