



THE DATASHEET OF SS-01GLT



Subminiature Basic Switch Offers High Reliability and Security

- The OMRON's best-selling micro switches of a wide variety from 0.1A to 10.1A.
- A variety of models are available, with operating force ranging from low to high.
- Two split springs ensure a high stability and durability of 30,000,000 operations.
- 1 mm MIN Contact Gap Models available for Interlock applications



SS

RoHS Compliant

Model Number Legend

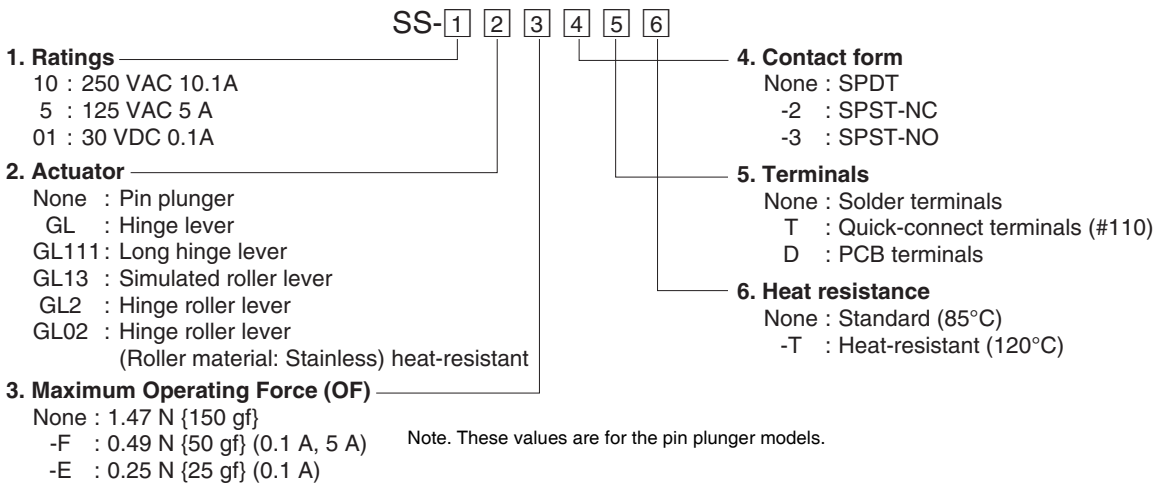

List of Models

●Standard Models

Actuator	Terminals	Contact Form	Maximum Operating Force (OF)	Ratings		
				10.1 A	5 A	0.1 A
Pin plunger 	Solder terminals	SPDT	1.47 N {150 gf}	SS-10	SS-5	SS-01
		SPST-NC		SS-10-2	SS-5-2	SS-01-2
		SPST-NO		SS-10-3	SS-5-3	SS-01-3
	Quick-connect terminals (#110)	SPDT		SS-10T	SS-5T	SS-01T
		SPST-NC		SS-10-2T	SS-5-2T	SS-01-2T
		SPST-NO		SS-10-3T	SS-5-3T	SS-01-3T
	PCB terminals	SPDT		SS-10D	SS-5D	SS-01D
		SPST-NC		SS-10-2D	SS-5-2D	SS-01-2D
		SPST-NO		SS-10-3D	SS-5-3D	SS-01-3D
	Solder terminals	SPDT	0.49 N {50 gf}	-	SS-5-F	SS-01-F
		SPST-NC		-	SS-5-F-2	SS-01-F-2
		SPST-NO		-	SS-5-F-3	SS-01-F-3
	Quick-connect terminals (#110)	SPDT		-	SS-5-FT	SS-01-FT
		SPST-NC		-	SS-5-F-2T	SS-01-F-2T
		SPST-NO		-	SS-5-F-3T	SS-01-F-3T
	PCB terminals	SPDT		-	SS-5-FD	SS-01-FD
		SPST-NC		-	SS-5-F-2D	SS-01-F-2D
		SPST-NO		-	SS-5-F-3D	SS-01-F-3D
	Solder terminals	SPDT	0.25 N {25 gf}	-	-	SS-01-E
		SPST-NC		-	-	SS-01-E-2
		SPST-NO		-	-	SS-01-E-3
	Quick-connect terminals (#110)	SPDT		-	-	SS-01-ET
		SPST-NC		-	-	SS-01-E-2T
		SPST-NO		-	-	SS-01-E-3T
PCB terminals	SPDT	-		-	SS-01-ED	
	SPST-NC	-		-	SS-01-E-2D	
	SPST-NO	-		-	SS-01-E-3D	

Separator (Sold Separately), Terminal Connector (Sold Separately) ➔ Refer to "Basic Switch Common Accessories"

Actuator	Terminals	Contact Form	Maximum Operating Force (OF)	Ratings				
				10.1 A	5 A	0.1 A		
 <p>Hinge lever</p>	Solder terminals	SPDT	0.49 N {50 gf}	SS-10GL	SS-5GL	SS-01GL		
		SPST-NC		SS-10GL-2	SS-5GL-2	SS-01GL-2		
		SPST-NO		SS-10GL-3	SS-5GL-3	SS-01GL-3		
	Quick-connect terminals (#110)	SPDT		0.49 N {50 gf}	SS-10GLT	SS-5GLT	SS-01GLT	
		SPST-NC			SS-10GL-2T	SS-5GL-2T	SS-01GL-2T	
		SPST-NO			SS-10GL-3T	SS-5GL-3T	SS-01GL-3T	
	PCB terminals	SPDT			0.49 N {50 gf}	SS-10GLD	SS-5GLD	SS-01GLD
		SPST-NC				SS-10GL-2D	SS-5GL-2D	SS-01GL-2D
		SPST-NO				SS-10GL-3D	SS-5GL-3D	SS-01GL-3D
	Solder terminals	SPDT	0.16 N {16 gf}			-	SS-5GL-F	SS-01GL-F
		SPST-NC				-	SS-5GL-F-2	SS-01GL-F-2
		SPST-NO				-	SS-5GL-F-3	SS-01GL-F-3
	Quick-connect terminals (#110)	SPDT		0.16 N {16 gf}		-	SS-5GL-FT	SS-01GL-FT
		SPST-NC				-	SS-5GL-F-2T	SS-01GL-F-2T
		SPST-NO				-	SS-5GL-F-3T	SS-01GL-F-3T
	PCB terminals	SPDT			0.16 N {16 gf}	-	SS-5GL-FD	SS-01GL-FD
		SPST-NC				-	SS-5GL-F-2D	SS-01GL-F-2D
		SPST-NO				-	SS-5GL-F-3D	SS-01GL-F-3D
	Solder terminals	SPDT	0.08 N {8 gf}			-	-	SS-01GL-E
		SPST-NC				-	-	SS-01GL-E-2
		SPST-NO				-	-	SS-01GL-E-3
	Quick-connect terminals (#110)	SPDT		0.08 N {8 gf}		-	-	SS-01GL-ET
		SPST-NC				-	-	SS-01GL-E-2T
		SPST-NO				-	-	SS-01GL-E-3T
	PCB terminals	SPDT			0.08 N {8 gf}	-	-	SS-01GL-ED
		SPST-NC				-	-	SS-01GL-E-2D
		SPST-NO				-	-	SS-01GL-E-3D
 <p>Long hinge lever</p>	Solder terminals	SPDT	0.39 N {40 gf}			SS-10GL111	SS-5GL111	SS-01GL111
		SPST-NC				SS-10GL111-2	SS-5GL111-2	SS-01GL111-2
		SPST-NO				SS-10GL111-3	SS-5GL111-3	SS-01GL111-3
	Quick-connect terminals (#110)	SPDT		0.39 N {40 gf}		SS-10GL111T	SS-5GL111T	SS-01GL111T
		SPST-NC				SS-10GL111-2T	SS-5GL111-2T	SS-01GL111-2T
		SPST-NO				SS-10GL111-3T	SS-5GL111-3T	SS-01GL111-3T
	PCB terminals	SPDT			0.39 N {40 gf}	SS-10GL111D	SS-5GL111D	SS-01GL111D
		SPST-NC				SS-10GL111-2D	SS-5GL111-2D	SS-01GL111-2D
		SPST-NO				SS-10GL111-3D	SS-5GL111-3D	SS-01GL111-3D
	Solder terminals	SPDT	0.12 N {12 gf}			-	SS-5GL111-F	SS-01GL111-F
		SPST-NC				-	SS-5GL111-F-2	SS-01GL111-F-2
		SPST-NO				-	SS-5GL111-F-3	SS-01GL111-F-3
	Quick-connect terminals (#110)	SPDT		0.12 N {12 gf}		-	SS-5GL111-FT	SS-01GL111-FT
		SPST-NC				-	SS-5GL111-F-2T	SS-01GL111-F-2T
		SPST-NO				-	SS-5GL111-F-3T	SS-01GL111-F-3T
	PCB terminals	SPDT			0.12 N {12 gf}	-	SS-5GL111-FD	SS-01GL111-FD
		SPST-NC				-	SS-5GL111-F-2D	SS-01GL111-F-2D
		SPST-NO				-	SS-5GL111-F-3D	SS-01GL111-F-3D
	Solder terminals	SPDT	0.06 N {6 gf}			-	-	SS-01GL111-E
		SPST-NC				-	-	SS-01GL111-E-2
		SPST-NO				-	-	SS-01GL111-E-3
	Quick-connect terminals (#110)	SPDT		0.06 N {6 gf}		-	-	SS-01GL111-ET
		SPST-NC				-	-	SS-01GL111-E-2T
		SPST-NO				-	-	SS-01GL111-E-3T
	PCB terminals	SPDT			0.06 N {6 gf}	-	-	SS-01GL111-ED
		SPST-NC				-	-	SS-01GL111-E-2D
		SPST-NO				-	-	SS-01GL111-E-3D
 <p>Simulated roller lever</p>	Solder terminals	SPDT	0.49 N {50 gf}			SS-10GL13	SS-5GL13	SS-01GL13
		SPST-NC				SS-10GL13-2	SS-5GL13-2	SS-01GL13-2
		SPST-NO				SS-10GL13-3	SS-5GL13-3	SS-01GL13-3
	Quick-connect terminals (#110)	SPDT		0.49 N {50 gf}		SS-10GL13T	SS-5GL13T	SS-01GL13T
		SPST-NC				SS-10GL13-2T	SS-5GL13-2T	SS-01GL13-2T
		SPST-NO				SS-10GL13-3T	SS-5GL13-3T	SS-01GL13-3T
	PCB terminals	SPDT			0.49 N {50 gf}	SS-10GL13D	SS-5GL13D	SS-01GL13D
		SPST-NC				SS-10GL13-2D	SS-5GL13-2D	SS-01GL13-2D
		SPST-NO				SS-10GL13-3D	SS-5GL13-3D	SS-01GL13-3D
	Solder terminals	SPDT	0.16 N {16 gf}			-	SS-5GL13-F	SS-01GL13-F
		SPST-NC				-	SS-5GL13-F-2	SS-01GL13-F-2
		SPST-NO				-	SS-5GL13-F-3	SS-01GL13-F-3
	Quick-connect terminals (#110)	SPDT		0.16 N {16 gf}		-	SS-5GL13-FT	SS-01GL13-FT
		SPST-NC				-	SS-5GL13-F-2T	SS-01GL13-F-2T
		SPST-NO				-	SS-5GL13-F-3T	SS-01GL13-F-3T
	PCB terminals	SPDT			0.16 N {16 gf}	-	SS-5GL13-FD	SS-01GL13-FD
		SPST-NC				-	SS-5GL13-F-2D	SS-01GL13-F-2D
		SPST-NO				-	SS-5GL13-F-3D	SS-01GL13-F-3D
	Solder terminals	SPDT	0.08 N {8 gf}			-	-	SS-01GL13-E
		SPST-NC				-	-	SS-01GL13-E-2
		SPST-NO				-	-	SS-01GL13-E-3
	Quick-connect terminals (#110)	SPDT		0.08 N {8 gf}		-	-	SS-01GL13-ET
		SPST-NC				-	-	SS-01GL13-E-2T
		SPST-NO				-	-	SS-01GL13-E-3T
	PCB terminals	SPDT			0.08 N {8 gf}	-	-	SS-01GL13-ED
		SPST-NC				-	-	SS-01GL13-E-2D
		SPST-NO				-	-	SS-01GL13-E-3D

Separator (Sold Separately), Terminal Connector (Sold Separately) ➔ Refer to "Basic Switch Common Accessories"

Actuator	Terminals	Contact Form	Maximum Operating Force (OF)	Ratings		
				10.1 A	5 A	0.1 A
Hinge roller lever 	Solder terminals	SPDT	0.49 N {50 gf}	SS-10GL2	SS-5GL2	SS-01GL2
		SPST-NC		SS-10GL2-2	SS-5GL2-2	SS-01GL2-2
		SPST-NO		SS-10GL2-3	SS-5GL2-3	SS-01GL2-3
	Quick-connect terminals (#110)	SPDT		SS-10GL2T	SS-5GL2T	SS-01GL2T
		SPST-NC		SS-10GL2-2T	SS-5GL2-2T	SS-01GL2-2T
		SPST-NO		SS-10GL2-3T	SS-5GL2-3T	SS-01GL2-3T
	PCB terminals	SPDT		SS-10GL2D	SS-5GL2D	SS-01GL2D
		SPST-NC		SS-10GL2-2D	SS-5GL2-2D	SS-01GL2-2D
		SPST-NO		SS-10GL2-3D	SS-5GL2-3D	SS-01GL2-3D
	Solder terminals	SPDT	0.16 N {16 gf}	-	SS-5GL2-F	SS-01GL2-F
		SPST-NC		-	SS-5GL2-F-2	SS-01GL2-F-2
		SPST-NO		-	SS-5GL2-F-3	SS-01GL2-F-3
	Quick-connect terminals (#110)	SPDT		-	SS-5GL2-FT	SS-01GL2-FT
		SPST-NC		-	SS-5GL2-F-2T	SS-01GL2-F-2T
		SPST-NO		-	SS-5GL2-F-3T	SS-01GL2-F-3T
	PCB terminals	SPDT		-	SS-5GL2-FD	SS-01GL2-FD
		SPST-NC		-	SS-5GL2-F-2D	SS-01GL2-F-2D
		SPST-NO		-	SS-5GL2-F-3D	SS-01GL2-F-3D
	Solder terminals	SPDT	0.08 N {8 gf}	-	-	SS-01GL2-E
		SPST-NC		-	-	SS-01GL2-E-2
		SPST-NO		-	-	SS-01GL2-E-3
	Quick-connect terminals (#110)	SPDT		-	-	SS-01GL2-ET
		SPST-NC		-	-	SS-01GL2-E-2T
		SPST-NO		-	-	SS-01GL2-E-3T
PCB terminals	SPDT	-		-	SS-01GL2-ED	
	SPST-NC	-		-	SS-01GL2-E-2D	
	SPST-NO	-		-	SS-01GL2-E-3D	

Heat Resistant Models

Actuator	Terminals	Contact Form	Maximum Operating Force (OF)	Ratings		
				10.1 A	5 A	0.1 A
Pin plunger 	Solder terminals	SPDT	1.47 N {150 gf}	SS-10-T	SS-5-T	SS-01-T
	Quick-connect terminals (#110)			SS-10T-T	SS-5T-T	SS-01T-T
	PCB terminals			SS-10D-T	SS-5D-T	SS-01D-T
Hinge lever 	Solder terminals		0.49 N {50 gf}	SS-10GL-T	SS-5GL-T	SS-01GL-T
	Quick-connect terminals (#110)			SS-10GLT-T	SS-5GLT-T	SS-01GLT-T
	PCB terminals			SS-10GLD-T	SS-5GLD-T	SS-01GLD-T
Long hinge lever 	Solder terminals		0.39 N {40 gf}	SS-10GL111-T	SS-5GL111-T	SS-01GL111-T
	Quick-connect terminals (#110)			SS-10GL111T-T	SS-5GL111T-T	SS-01GL111T-T
	PCB terminals			SS-10GL111D-T	SS-5GL111D-T	SS-01GL111D-T
Simulated roller lever 	Solder terminals	0.49 N {50 gf}	SS-10GL13-T	SS-5GL13-T	SS-01GL13-T	
	Quick-connect terminals (#110)		SS-10GL13T-T	SS-5GL13T-T	SS-01GL13T-T	
	PCB terminals		SS-10GL13D-T	SS-5GL13D-T	SS-01GL13D-T	
Hinge roller lever (Roller material: stainless steel) 	Solder terminals	0.49 N {50 gf}	SS-10GL02-T	SS-5GL02-T	SS-01GL02-T	
	Quick-connect terminals (#110)		SS-10GL02T-T	SS-5GL02T-T	SS-01GL02T-T	
	PCB terminals		SS-10GL02D-T	SS-5GL02D-T	SS-01GL02D-T	

1 mm MIN Contact Gap Models

Actuator	Terminals	Contact Form	Maximum Operating Force (OF)	Ratings		
				10.1 A	5 A	0.1 A
Long hinge lever 	Solder terminals	SPST-NO	0.54 N {55 gf}	-	SS-5FL111-3	-
	Quick-connect terminals (#110)			-	SS-5FL111-3T	-

Contact Form

SPDT



SPST-NC



SPST-NO



Contact Specifications

Item	Model	SS-10 models	SS-5 models	SS-01 models	SS-5F models
		Specification	Rivet		Crossbar
Material	Silver alloy	Silver	Gold alloy	Silver	
Gap (standard value)	0.5 mm		0.25 mm	1mm min.	
Inrush current	NC	20 A max.		1 A max.	-
	NO	15 A max.	10 A max.	1 A max.	10 A max.
Minimum applicable load (reference value)*	5 VDC 160 mA		5 VDC 1 mA	5 VDC 160 mA	

* Please refer to "Using Micro Loads" in "Precautions" for more information on the minimum applicable load.

Separator (Sold Separately), Terminal Connector (Sold Separately) ➔ Refer to "Basic Switch Common Accessories"

Ratings

Model	Item Rated voltage	Resistive load
SS-10 models	250 VAC	10.1 A
SS-5 models	125 VAC	5 A
	250 VAC	3 A
SS-01 models	125 VAC	0.1 A
	30 VDC	0.1 A
SS-5F models	250 VAC	3 A
	30 VDC	5 A

Note. The above rating values apply under the following test conditions.
 (1) Ambient temperature: 20±2°C
 (2) Ambient humidity: 65±5%
 (3) Operating frequency: 30 operations/min

Approved Safety Standards

Models shown in the "List of Models" are UL and CSA approved models.

Note. Note that heat resistant models are not standard approved models.

UL (UL1054)/CSA (CSA C22.2 No.55)

Model Rated voltage	SS-10	SS-5	SS-01	SS-5F
125 VAC	-	5 A	0.1 A	-
250 VAC	10.1A	3 A	-	3 A
30 VDC	-	-	0.1 A	5 A

Consult your OMRON sales representative for specific models with VDE standard approvals.
VDE (EN61058-1)

Model Rated voltage	SS-10	SS-5	SS-5F
250 VAC	10 A	5 A	3 A

Testing conditions: 5E4 (50,000 operations)
 T85 (0°C to 85°C)

Characteristics

Item	Model	SS-10 models	SS-5 models	SS-01 models	SS-5F models
Permissible operating speed		0.1 mm to 1 m/s (for pin plunger models)			
Permissible operating frequency	Mechanical	400 operations/min			
	Electrical	60 operations/min			
Insulation resistance		100 MΩ min. (at 500 VDC with insulation tester)			
Contact resistance (initial value)	OF 1.47 N models	30 mΩ max.		50 mΩ max.	30 mΩ max.
	OF 0.49 N models	-	50 mΩ max.	100 mΩ max.	-
	OF 0.25 N models	-	-	150 mΩ max.	-
Dielectric strength *1	Between terminals of the same polarity	1,000 VAC 50/60 Hz for 1 min		600 VAC 50/60 Hz for 1 min	1,000 VAC 50/60 Hz for 1 min
	Between current-carrying metal parts and ground	1,500 VAC 50/60 Hz for 1 min			
	Between each terminals and non-current-carrying metal parts	1,500 VAC 50/60 Hz for 1 min			
Vibration resistance *2	Malfunction	10 to 55 Hz, 1.5 mm double amplitude			
Shock resistance	Durability	OF 1.47 N models	1,000 m/s ² {approx. 100G} max.		-
		OF 0.49 N models	500 m/s ² {approx. 50G} max.		-
		OF 0.25 N models	500 m/s ² {approx. 50G} max.		-
	Malfunction *2	OF 1.47 N models	300 m/s ² {approx. 30G} max.		-
		OF 0.49 N models	200 m/s ² {approx. 20G} max.		-
Durability *3	Mechanical	10,000,000 operations min. (60 operations/min)	30,000,000 operations min. (60 operations/min)	100,000 operations min. (60 operations/min)	100,000 operations min. (30 operations/min)
	Electrical	50,000 operations min. (30 operations/min)	200,000 operations min. (30 operations/min)	100,000 operations min. (30 operations/min)	-
Degree of protection		IEC IP40			
Degree of protection against electric shock		Class I			
Proof tracking index (PTI)		175			
Ambient operating temperature		-25°C to +85°C (at ambient humidity of 60% max.) (with no icing or condensation)			
Ambient operating humidity		85% max. (for +5°C to +35°C)			
Weight		Approx. 1.6g (pin plunger models)			

Note. The data given above are initial values.

- *1. The values for dielectric strength shown are for models with a Separator (refer to "Micro Switch Common Accessories").
- *2. The values are at Free Position and Total Travel Position values for pin plunger, and Total Travel Position value for lever. Close or open circuit of the contact is 1ms max.
- *3. For testing conditions, consult your OMRON sales representative.

Terminals/Appearances (Unit: mm)

●Solder terminals



●Quick connect terminals (#110)



●PCB terminals



<PCB Mounting Dimensions (Reference)>



Note. SPST-NO terminal models do not have NC terminal.

Mounting Holes (Unit: mm)



Dimensions (Unit: mm) and Operating Characteristics

The illustrations and drawings are for solder terminals models.

Refer to "Terminals/Apearances" of the previous page for details on models with quick connect terminals (#110) or PCB terminals.

●Pin plunger

- SS-10
- SS-5 (-F)
- SS-01 (-E, -F)

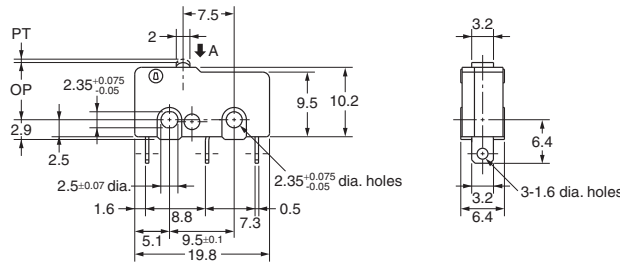
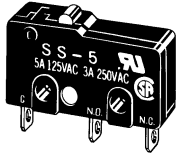

Model		SS-10	SS-5 SS-01	SS-5-F SS-01-F	SS-01-E
Operating Characteristics					
Operating Force	OF Max.	1.47 N {150 gf}	1.47 N {150 gf}	0.49 N {50 gf}	0.25 N {25 gf}
Releasing Force	RF Min.	0.25 N {25 gf}	0.25 N {25 gf}	0.04 N {4 gf}	0.02 N {2 gf}
Pretravel	PT Max.	0.6 mm	0.5 mm	0.5 mm	0.5 mm
Overtravel	OT Min.	0.4 mm	0.5 mm	0.5 mm	0.5 mm
Movement Differential	MD Max.	0.12 mm	0.1 mm	0.1 mm	0.1 mm
Operating Position	OP	8.4±0.5 mm			

●Hinge lever

- SS-10GL
- SS-5GL (-F)
- SS-01GL (-E, -F)

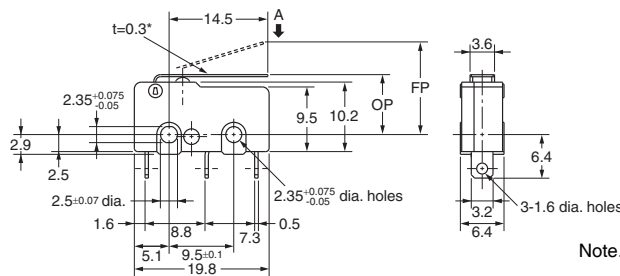
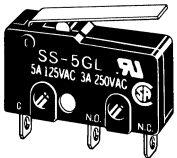

Note. The indicated reference values of RF are for cases where the lever weight is not applied to the plunger.

* Stainless-steel lever

Model		SS-10GL	SS-5GL SS-01GL	SS-5GL-F SS-01GL-F	SS-01GL-E
Operating Characteristics					
Operating Force	OF Max.	0.49 N {50 gf}	0.49 N {50 gf}	0.16 N {16 gf}	0.08 N {8 gf}
Releasing Force	RF Min.	0.06 N {6 gf}	0.06 N {6 gf}	0.02 N {2 gf}	0.01 N {1 gf} (reference value)
Overtravel	OT Min.	1.0 mm	1.2 mm	1.2 mm	1.2 mm
Movement Differential	MD Max.	1.0 mm	0.8 mm	0.8 mm	0.8 mm
Free Position	FP Max.	13.6 mm			
Operating Position	OP	8.8±0.8 mm			

●Long hinge lever

- SS-10GL111
- SS-5GL111 (-F)
- SS-01GL111 (-E, -F)
- SS-5FL111-3

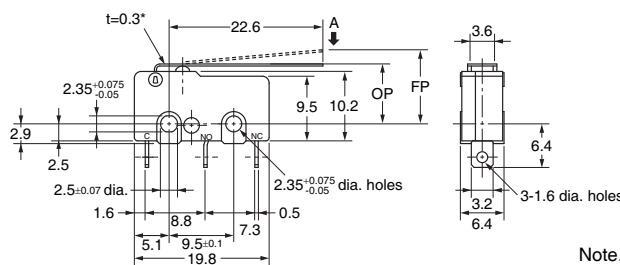
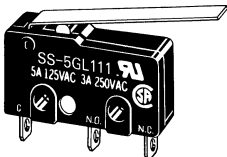

Note. The indicated reference values of RF are for cases where the lever weight is not applied to the plunger.

* Stainless-steel lever

Model		SS-10GL111	SS-5GL111 SS-01GL111	SS-5FL111-3	SS-5GL111-F SS-01GL111-F	SS-01GL111-E
Operating Characteristics						
Operating Force	OF Max.	0.39 N {40 gf}	0.39 N {40 gf}	0.54 N {55 gf}	0.12 N {12 gf}	0.06 N {6 gf}
Releasing Force	RF Min.	0.03 N {3 gf}	0.03 N {3 gf}	0.01 N {1 gf}	0.02 N {2 gf} (reference value)	0.003 N {0.3 gf} (reference value)
Overtravel	OT Min.	1.2 mm	1.2 mm	1.0 mm	1.2 mm	1.2 mm
Movement Differential	MD Max.	1.2 mm	1.2 mm	3.0 mm	1.2 mm	1.2 mm
Free Position	FP Max.	16.8 mm				
Operating Position	OP	8.8±1.5 mm				8.8±2 mm

Note 1. Unless otherwise specified, a tolerance of ±0.4 mm applies to all dimensions.

Note 2. The operating characteristics are for operation in the A direction (↓).

● Simulated roller lever

SS-10GL13
 SS-5GL13 (-F)
 SS-01GL13 (-E, -F)



* Stainless-steel lever

Note. The indicated reference values of RF are for cases where the lever weight is not applied to the plunger.

Operating Characteristics		Model	SS-10GL13	SS-5GL13 SS-01GL13	SS-5GL13-F SS-01GL13-F	SS-01GL13-E
Operating Force	OF	Max.	0.49 N {50 gf}	0.49 N {50 gf}	0.16 N {16 gf}	0.08 N {8 gf}
	Releasing Force	RF	Min.	0.06 N {6 gf}	0.02 N {2 gf}	0.01 N {1 gf} (reference value)
Overtravel	OT	Min.	1.0 mm	1.2 mm	1.2 mm	1.2 mm
Movement Differential	MD	Max.	1.0 mm	0.8 mm	0.8 mm	0.8 mm
Free Position	FP	Max.	15.5 mm			
Operating Position	OP		10.7±0.8 mm			

● Hinge roller lever

SS-10GL2
 SS-5GL2 (-F)
 SS-01GL2 (-E, -F)



*1. Stainless-steel lever
 *2. Polyacetal resin roller

Note. The indicated reference values of RF are for cases where the lever weight is not applied to the plunger.

Operating Characteristics		Model	SS-10GL2	SS-5GL2 SS-01GL2	SS-5GL2-F SS-01GL2-F	SS-01GL2-E
Operating Force	OF	Max.	0.49 N {50 gf}	0.49 N {50 gf}	0.16 N {16 gf}	0.08 N {8 gf}
	Releasing Force	RF	Min.	0.06 N {6 gf}	0.02 N {2 gf}	0.01 N {1 gf} (reference value)
Overtravel	OT	Min.	1.0 mm	1.2 mm	1.2 mm	1.2 mm
Movement Differential	MD	Max.	1.0 mm	0.8 mm	0.8 mm	0.8 mm
Free Position	FP	Max.	19.3mm			
Operating Position	OP		14.5±0.8mm			

Note 1. Unless otherwise specified, a tolerance of ±0.4 mm applies to all dimensions.

Note 2. The operating characteristics are for operation in the A direction (↓).

Precautions

★Please refer to "Common Precautions" for correct use.

Cautions

●Soldering

- Complete the soldering at the iron tip temperature below 350°C within 5 seconds, and do not apply any external force for 1 minute after soldering. Soldering at an excessively high temperature or soldering for more than 5 seconds may deteriorate the characteristics of the Switch.
- Be sure to apply only the minimum required amount of flux. Switch may have contact failures if flux intrudes into the interior of the Switch.
- If the PCB terminal models are soldered in the solder bath, flux will permeate inside the Switch and cause contact failure. Therefore, manually solder the PCB terminal.

Correct Use

●Mounting

- Use M2.3 mounting screw with plane washers or spring washers to securely mount the Switch. Tighten the screws to a torque of 0.23 to 0.26 N·m {2.3 to 2.7 kgf·cm}.
- Mount the Switch onto a flat surface. Mounting on an uneven surface may cause deformation of the Switch, resulting in faulty operation or breakage in the housing.

●Using Micro Loads

Using a model for ordinary loads to open or close the contact of a micro load circuit may result in faulty contact. Use models that operate in the following range. However, even when using micro load models within the following operating range, if inrush current occurs when the contact is opened or closed, it may increase the contact wear and so decrease durability. Therefore, insert a contact protection circuit where necessary. The N-level reference value applies for the minimum applicable load. This value indicates the malfunction reference level for the reliability level of 60% (λ_{60}).

(JIS C5003)

The equation, $\lambda_{60}=0.5 \times 10^{-6} / \text{operation}$ indicates that the estimated malfunction rate is less than $\frac{1}{2,000,000}$ operations with a reliability level of 60%.





- Application examples provided in this document are for reference only. In actual applications, confirm equipment functions and safety before using the product.
- Consult your OMRON representative before using the product under conditions which are not described in the manual or applying the product to nuclear control systems, railroad systems, aviation systems, vehicles, combustion systems, medical equipment, amusement machines, safety equipment, and other systems or equipment that may have a serious influence on lives and property if used improperly. Make sure that the ratings and performance characteristics of the product provide a margin of safety for the system or equipment, and be sure to provide the system or equipment with double safety mechanisms.

Note: Do not use this document to operate the Unit.

Looking for pricing, stock, or lifecycle information?

Click below to explore more details on WIN SOURCE:

-  [View SS-01GLT on WIN SOURCE](#)
-  [Omron Information](#)

Optimize Your Supply Chain with WIN SOURCE Solutions

-  Global Sourcing Solution
-  Obsolete Management
-  Cost Control Management
-  Shortage Management
-  Alternative Solution
-  Excess Inventory Management