



**THE DATASHEET OF
SR3S 01 GY 5N/5N 01 R01 M**



Switch Rocker – SR3



DTCs Switch Rockers have been developed to provide the reliability required in demanding environmental conditions such as multifunction grips, dashboards or armrest controls for heavy duty industrial applications.

The switching system is distinguished by its high reliability with a life expectation of at least one million operations.

The rocker modules have been designed for the typical switching function in 'off-road' machinery and other rough environments.

Electrical Data		
Switching current max.	Switch 1	S1: 7 mA (1K3 Ohm)
	Switch 2	S2: 9 mA (680 Ohm)
Mechanical Data		
Life		1 million cycles
Operating temperature		
- Storage		- 40°C to 85°C
- Working		- 35°C to 70°C
Operating force		5 N
Vertical load maximum		30 N
Protection Level		IP 65 (from above when mounted)
Rocker deflection angle		± 12°

Main Features

- Life greater than 1 million cycles
- Precise tactile feedback of switches
- Protection Class IP65
- DTCs K12 switch technology for high reliability

Custom modifications

- Output characteristics
- Operating force
- Switch characteristics / functions
- Actuator colour

Switch Rocker – SR3

Ordering code		1	2	3	4	5	6	7	
	Example	SR3S	01	GY	5N/5N	01	R	00	M
1 Type	SR3 = switch rocker 3 S = varnished PCB N = non varnished PCB								
2 Actuator Shape	01 = long lever 02 = short lever 05 = thumb lever								
3 Actuator Colour	GY = grey								
4 Operation Force	5N/5N = 5 N left / 5N right								
5 Switch assembly	01 = switch 1 (S1) K12P BK 1 5N switch 2 (S2) K12P BK 1 5N								
6 Output	R = resistor (Ohm)								
Output configuration	00 = 0 Ohm 01 = S1: 1K3 Ohm S2: 680 Ohm								
7 Mechanical function	M = left / right momentary (center turn position)								

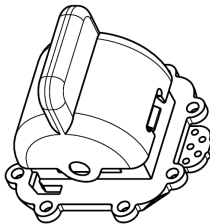
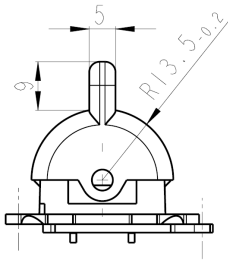

Module actuator shape 01

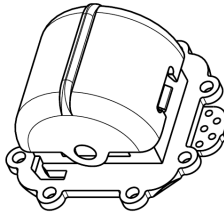
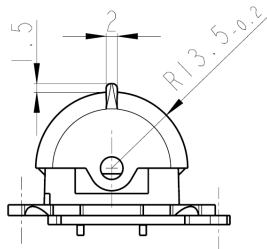

Module actuator shape 02

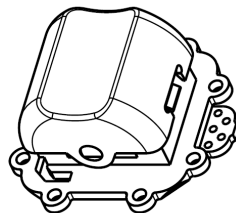
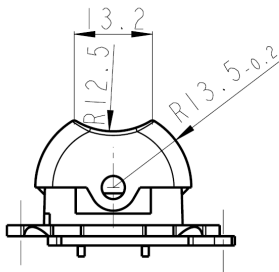

Module actuator shape 05

Switch Rocker – SR3

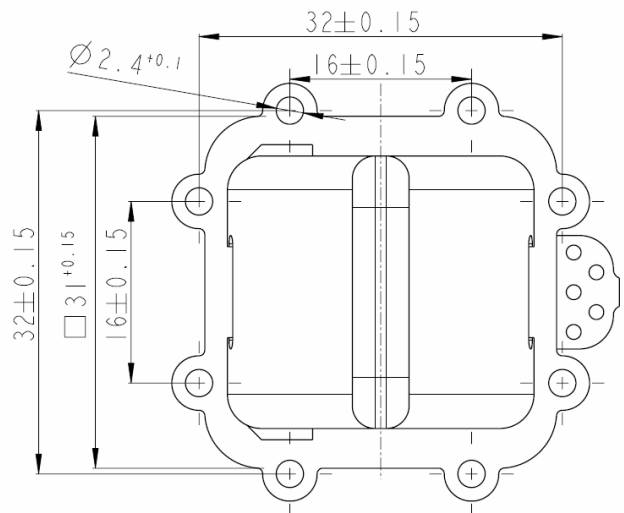
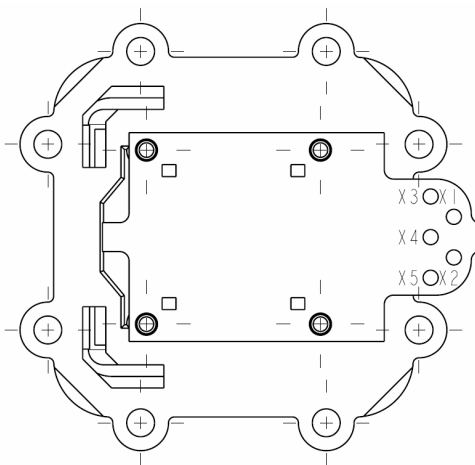
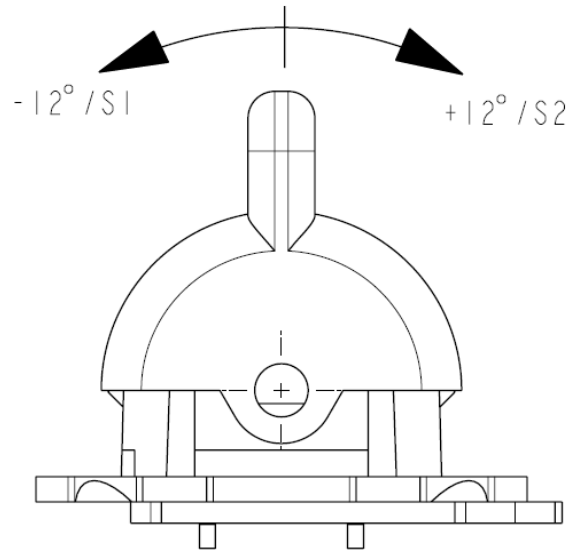

Pin assignment:

PIN	ALLOCATION	FUNCTION
X5	S3_I S3_ext	RESERVED
X4	S3_VCC S3_ext	RESERVED
X3	S2_OUT	OUTPUT PUSHBUTTON S2
X2	S1_OUT	OUTPUT PUSHBUTTON S1
X1	VCC_IN	VOLTAGE SUPPLY

Output configuration:

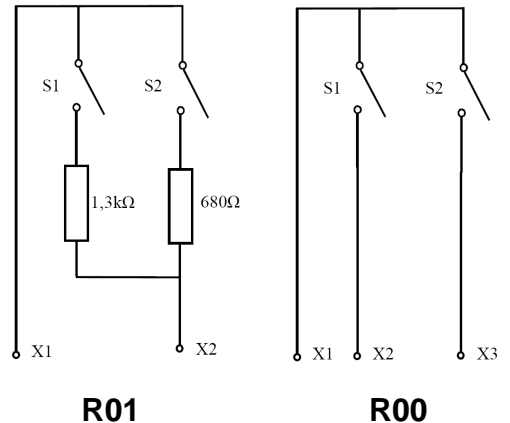

DeltaTech Controls – A CoActive Technologies Company - worldwide Facilities

With sales offices and manufacturing facilities located worldwide, please visit our website at www.deltatechcontrols.com for a complete listing and to find the office nearest to you.

France

2 Boulevard Michael Faraday
Arlington Square, Batiment B
Serris - F77716 Marne La Vallee Cedex 4
France
phone: + 33 160 24 51 51
fax: + 33 (0)3 84 69 08 97

Germany

Holzhauser Strasse 26-32
D-13509 Berlin
Germany
phone: + 49 30 43 999 0
fax: + 49 30 43 999 203

Hong Kong

Unit 901, West Tower
Shun Tak Center
168-200 Connaught Road
Central, Hong Kong
phone: + 852 2732 2720
fax: + 852 2732 2919

USA

5288 Valley Industrial Blvd. S
Shakopee, MN 55379
USA
phone: + 1 952 403 7418
fax: + 1 952 233 9707





No information and data contained in this publication shall be construed to create any liability on the part of DeltaTech Controls GmbH. Any new issue of this publication shall automatically invalidate and supersede any and all previous issues. Dimensions are subject to change without prior notice.

All Copyrights belong to DeltaTech Controls GmbH and CoActive Technologies.
All other trademarks or registered trademarks are property of their respective owners.
All data subject to change without notice. ©2007

Looking for pricing, stock, or lifecycle information?

Click below to explore more details on WIN SOURCE:

-  [View SR3S 01 GY 5N/5N 01 R01 M on WIN SOURCE](#)
-  [C&K Components Information](#)

Optimize Your Supply Chain with WIN SOURCE Solutions

-  Global Sourcing Solution
-  Obsolete Management
-  Cost Control Management
-  Shortage Management
-  Alternative Solution
-  Excess Inventory Management