



**THE DATASHEET OF
SRN91-24BB**



HONEYWELL
PART NUMBER



REV	DOCUMENT	CHANGED BY	CHECK
A	0016306	LKM 24OCT05	VA

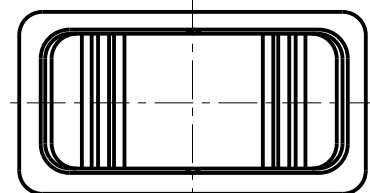

POS1 POS2 POS3

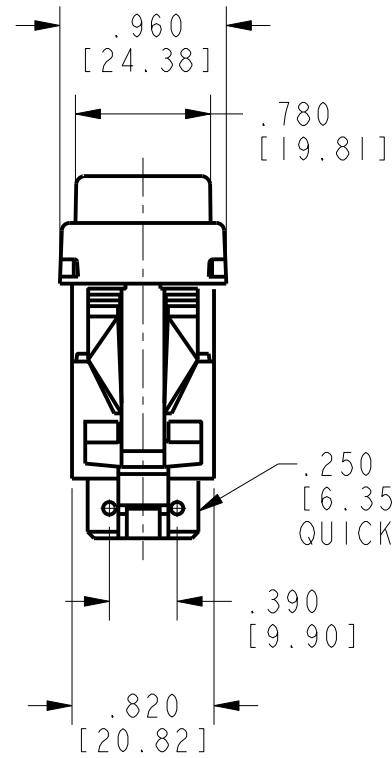
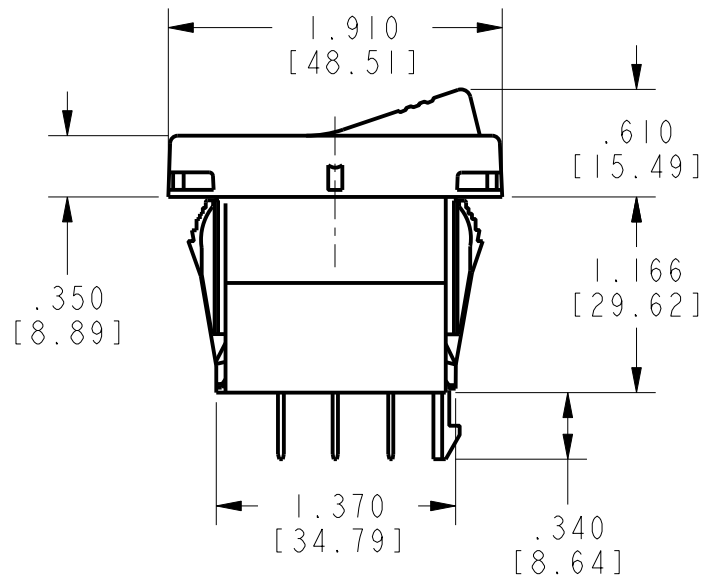

.250 [6.35] WIDE QUICK CONNECT TABS

.250 X .032 [6.35] [.81] QUICK CONNECT TABS

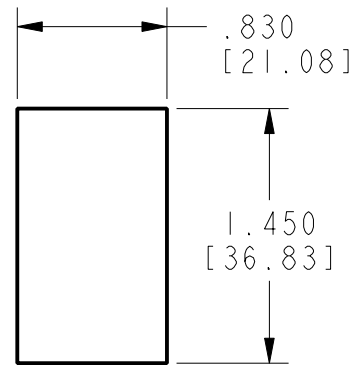

MOUNTING HOLE
PANEL THICKNESS (SNAP-IN BRACKET)
.030 MIN - .187 MAX
[.76] [4.75]

CIRCUITRY

NUMBER OF POLES—
(1=SP-SINGLE POLE, USES TERMINALS 1-2-3)
(2=DP-DOUBLE POLE, USES TERMINALS 1-2-3 AND 4-5-6)

TERMINAL STYLE

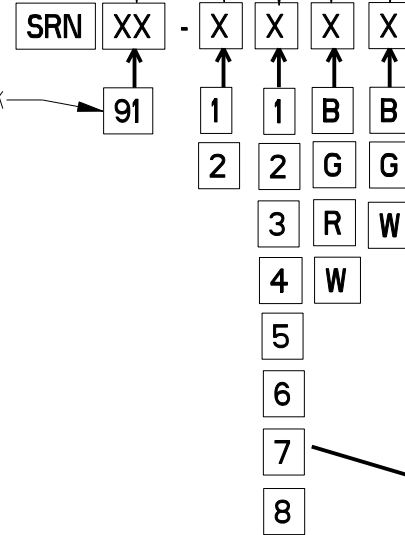

ACTUATOR COLOR
(B=BLACK, G=GRAY, R=RED, W=WHITE)

BASE/BEZEL COLOR
(B=BLACK, G=GRAY, W=WHITE)

ELECTRICAL RATINGS
AND APPROVALS

10A 250VAC 1/2HP
15A 125VAC 1/2HP
UL, CSA

	CIRCUIT MADE WITH ROCKER IN		
	POSITION 3 (1&2, 4&5)	POSITION 2	POSITION 1 (2&3, 5&6)
1	ON	OFF	ON
2	OFF	NONE	ON
3	ON	NONE	ON
4	(OFF)	NONE	ON
5	(ON)	OFF	ON
6	OFF	NONE	(ON)
7	(ON)	OFF	(ON)
8	(ON)	NONE	ON

- 1 - OPERATING TEMPERATURE RANGE : -40°F TO +185°F (-40°C TO +85°C)
- 2 - ELECTRICAL LIFE : 50,000 CYCLES MOMENTARY, 100,000 CYCLES MAINTAINED
- 3 - MECHANICAL LIFE : 150,000 CYCLES MIN
- SEE DIAGRAM FOR CATALOGING SCHEME
- PARENTHESIS DENOTE MOMENTARY ACTION
- 6 - SEALED TO IP68

DESIGN UNITS: INCH	
TOLERANCES UNLESS NOTED:	
NO PLACE	X ± 0.040
ONE PLACE	.X ± 0.030
TWO PLACE	.XX ± 0.015
THREE PLACE	.XXX ± 0.015
FOUR PLACE	.XXXX ± 0.0005
ANGLES	X ± 2

THIRD ANGLE PROJECTION



DRAWN	TSG	15 JUL 05
CHECK	-	-
THIS DRAWING COVERS A PROPRIETARY ITEM AND IS THE PROPERTY OF HONEYWELL. THIS DRAWING IS NOT TO BE COPIED OR USED WITHOUT THE PERMISSION OF HONEYWELL.		
INTERPRET PER ASME Y14.5M-1994 OTHER HONEYWELL ENGINEERING STANDARDS MAY APPLY		
Pro/ENGINEER	2D	

Honeywell			
TITLE SWITCH , ROCKER			
SIZE	TYPE	DRAWING NAME	REV
B	I	SRN SERIES CHART 1	A
SCALE	-	SHEET	1 OF 1

Looking for pricing, stock, or lifecycle information?

Click below to explore more details on WIN SOURCE:

 [View SRN91-24BB on WIN SOURCE](#)

 [Honeywell Information](#)

Optimize Your Supply Chain with WIN SOURCE Solutions

-  Global Sourcing Solution
-  Obsolete Management
-  Cost Control Management
-  Shortage Management
-  Alternative Solution
-  Excess Inventory Management