



**THE DATASHEET OF  
S560-6600-JJ-F**







# SHDSL MAGNETICS

S560-6600-JJ

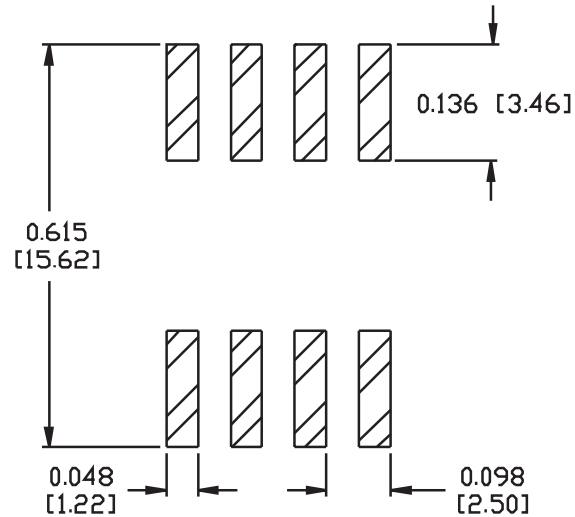
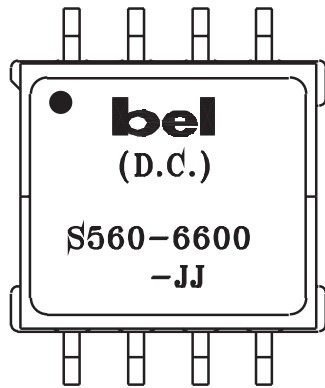

SUGGESTED PAD LAYOUT

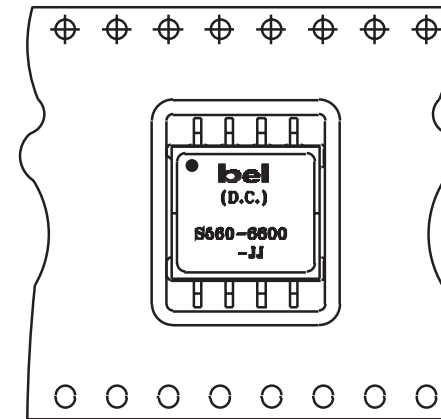
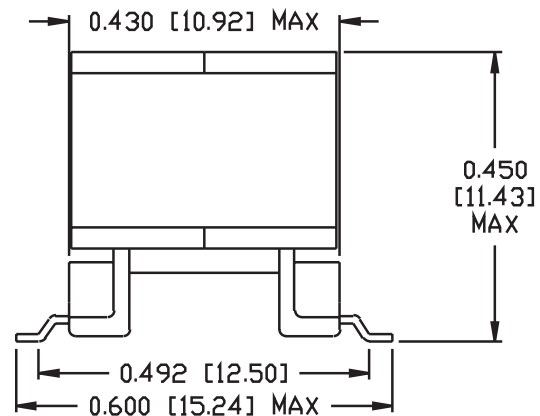
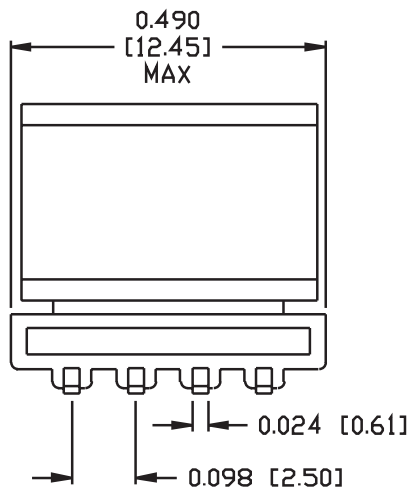



USER FEED DIRECTION

ORIENTATION OF COMPONENT INSIDE POCKET

TAPE WIDTH	32MM
POCKET PITCH	24MM
QUANTITY OF COMPONENTS PER REEL	200
PLASTIC REEL OUTER DIAMETER	13 INCHES
PLASTIC REEL HUB DIAMETER	4 INCHES
COMPLY WITH EIA 481-3	

## Looking for pricing, stock, or lifecycle information?

Click below to explore more details on WIN SOURCE:

-  [View S560-6600-JJ-F on WIN SOURCE](#)
-  [Bel Fuse Inc. Information](#)

## Optimize Your Supply Chain with WIN SOURCE Solutions

-  Global Sourcing Solution
-  Obsolete Management
-  Cost Control Management
-  Shortage Management
-  Alternative Solution
-  Excess Inventory Management