

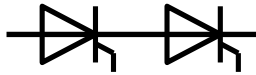

**THE DATASHEET OF
TD170N12KOFHPSA1**





Key Parameters

| | |
|---------------------|------------------------------|
| V_{DRM} / V_{RRM} | 1200 V – 1800 V |
| I_{TAVM} | 170 A ($T_C=85\text{ °C}$) |
| I_{TSM} | 5200 A |
| V_{T0} | 0,95 V |
| r_T | 1,0 m Ω |
| R_{thJC} | 0,17 KW |
| Base plate | 50 mm |
| Weight | 800 g |



For type designation please refer to actual short form catalog

<http://www.ifbip.com/catalog>

Merkmale

- Druckkontakt-Technologie für hohe Zuverlässigkeit
- Advanced Medium Power Technology (AMPT)
- Industrie-Standard-Gehäuse
- Elektrisch isolierte Bodenplatte

Features

- Pressure contact technology for high reliability
- Advanced Medium Power Technology (AMPT)
- Industrial standard package
- Electrically insulated base plate

Typische Anwendungen

- Sanftanlasser
- Gleichrichter für Antriebsapplikationen
- Kurzschließer-Applikationen
- Leistungssteller
- Gleichrichter für UPS
- Batterieladegleichrichter
- Statische Umschalter

Typical Applications

- Soft starter
- Rectifier for drives applications
- Crowbar applications
- Power controllers
- Rectifiers for UBS
- Battery chargers
- Static switches

| | | |
|----------------------------------|----------------|-------------------------|
| | | |
| content of customer DMX code | DMX code digit | DMX code digit quantity |
| serial number | 1..5 | 5 |
| SAP material number | 6..12 | 7 |
| Internal production order number | 13..20 | 8 |
| datecode (production year) | 21..22 | 2 |
| datecode (production week) | 23..24 | 2 |

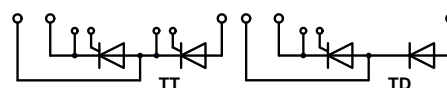

www.ifbip.com
support@infineon-bip.com

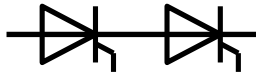

Technische Information / technical information



Netz-Thyristor-Modul
Phase Control Thyristor Module

TT170N

Infineon Technologies Bipolar
GmbH & Co. KG

Elektrische Eigenschaften / Electrical properties

Höchstzulässige Werte / Maximum rated values

| | TT170N | TD170N | | | |
|--|---|----------------------------------|--------------|------------------|--|
| Periodische Vorwärts- und Rückwärts-Spitzensperrspannung repetitive peak forward off-state and reverse voltages | $T_{vj} = -40^{\circ}\text{C} \dots T_{vj\text{ max}}$ | $V_{\text{DRM}}, V_{\text{RRM}}$ | 1200 1600 | 1400 1800 | V V |
| Vorwärts-Stoßspitzensperrspannung non-repetitive peak forward off-state voltage | $T_{vj} = -40^{\circ}\text{C} \dots T_{vj\text{ max}}$ | V_{DSM} | 1200 1600 | 1400 1800 | V V |
| Rückwärts-Stoßspitzensperrspannung non-repetitive peak reverse voltage | $T_{vj} = +25^{\circ}\text{C} \dots T_{vj\text{ max}}$ | V_{RSM} | 1300 1700 | 1500 1900 | V V |
| Durchlaßstrom-Grenzeffektivwert maximum RMS on-state current | | I_{TRMSM} | | 350 | A |
| Dauergrenzstrom average on-state current | $T_{\text{C}} = 85^{\circ}\text{C}$ $T_{\text{C}} = 68^{\circ}\text{C}$ | I_{TAVM} | | 170 223 | A |
| Stoßstrom-Grenzwert surge current | $T_{vj} = 25^{\circ}\text{C}, t_{\text{p}} = 10\text{ms}$ $T_{vj} = T_{vj\text{ max}}, t_{\text{p}} = 10\text{ms}$ | I_{TSM} | | 5200 4600 | A A |
| Grenzlastintegral I^2t -value | $T_{vj} = 25^{\circ}\text{C}, t_{\text{p}} = 10\text{ms}$ $T_{vj} = T_{vj\text{ max}}, t_{\text{p}} = 10\text{ms}$ | I^2t | | 135000 106000 | A^2s A^2s |
| Kritische Stromsteilheit critical rate of rise of on-state current | DIN IEC 747-6 $f = 50\text{Hz}, i_{\text{GM}} = 1\text{A}, di_{\text{G}}/dt = 1\text{A}/\mu\text{s}$ | $(di_{\text{T}}/dt)_{\text{cr}}$ | | 150 | $\text{A}/\mu\text{s}$ |
| Kritische Spannungssteilheit critical rate of rise of off-state voltage | $T_{vj} = T_{vj\text{ max}}, V_{\text{D}} = 0,67 V_{\text{DRM}}$ 6.Kennbuchstabe / 6 th letter F | $(dv_{\text{D}}/dt)_{\text{cr}}$ | | 1000 | $\text{V}/\mu\text{s}$ |

Charakteristische Werte / Characteristic values

| | | | | | |
|---|--|------------------------------|--------------|---------|------------------|
| Durchlaßspannung on-state voltage | $T_{vj} = T_{vj\text{ max}}, i_{\text{T}} = 600\text{ A}$ | V_{T} | max. | 1,65 | V |
| Schleusenspannung threshold voltage | $T_{vj} = T_{vj\text{ max}}$ | $V_{(\text{TO})}$ | max. | 0,95 | V |
| Ersatzwiderstand slope resistance | $T_{vj} = T_{vj\text{ max}}$ | r_{T} | max. | 1,0 | $\text{m}\Omega$ |
| Zündstrom gate trigger current | $T_{vj} = 25^{\circ}\text{C}, V_{\text{D}} = 12\text{V}$ | I_{GT} | max. | 200 | mA |
| Zündspannung gate trigger voltage | $T_{vj} = 25^{\circ}\text{C}, V_{\text{D}} = 12\text{V}$ | V_{GT} | max. | 2,0 | V |
| Nicht zündender Steuerstrom gate non-trigger current | $T_{vj} = T_{vj\text{ max}}, V_{\text{D}} = 12\text{V}$ $T_{vj} = T_{vj\text{ max}}, V_{\text{D}} = 0,5 V_{\text{DRM}}$ | I_{GD} | max. max. | 10 5 | mA mA |
| Nicht zündende Steuerspannung gate non-trigger voltage | $T_{vj} = T_{vj\text{ max}}, V_{\text{D}} = 0,5 V_{\text{DRM}}$ | V_{GD} | max. | 0,2 | V |
| Haltestrom holding current | $T_{vj} = 25^{\circ}\text{C}, V_{\text{D}} = 12\text{V}, R_{\text{A}} = 1\Omega$ | I_{H} | max. | 300 | mA |
| Einraststrom latching current | $T_{vj} = 25^{\circ}\text{C}, V_{\text{D}} = 12\text{V}, R_{\text{GK}} \geq 10\Omega$ $i_{\text{GM}} = 1\text{A}, di_{\text{G}}/dt = 1\text{A}/\mu\text{s}, t_{\text{g}} = 20\mu\text{s}$ | I_{L} | max. | 1200 | mA |
| Vorwärts- und Rückwärts-Sperrstrom forward off-state and reverse current | $T_{vj} = T_{vj\text{ max}}$ $V_{\text{D}} = V_{\text{DRM}}, V_{\text{R}} = V_{\text{RRM}}$ | $i_{\text{D}}, i_{\text{R}}$ | max. | 50 | mA |
| Zündverzug gate controlled delay time | DIN IEC 747-6 $T_{vj} = 25^{\circ}\text{C}, i_{\text{GM}} = 1\text{A}, di_{\text{G}}/dt = 1\text{A}/\mu\text{s}$ | t_{gd} | max. | 3 | μs |

| | | | |
|--------------|----|----------------------|------------|
| prepared by: | HR | date of publication: | 2014-04-23 |
| approved by: | ML | revision: | 3.1 |

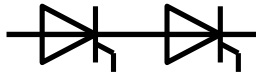

Technische Information / technical information



Netz-Thyristor-Modul
Phase Control Thyristor Module

TT170N

Infineon Technologies Bipolar
GmbH & Co. KG

Elektrische Eigenschaften / Electrical properties

Charakteristische Werte / Characteristic values

| | | | | | |
|--|--|------------|------|------------|---------------|
| Freiwerdezeit circuit commutated turn-off time | $T_{vj} = T_{vj\max}$, $i_{TM} = I_{TAVM}$ $V_{RM} = 100\text{ V}$, $v_{DM} = 0,67 V_{DRM}$ $dv_D/dt = 20\text{ V}/\mu\text{s}$, $-di_T/dt = 10\text{ A}/\mu\text{s}$ 5.Kennbuchstabe / 5 th letter O | t_q | typ. | 250 | μs |
| Isolations-Prüfspannung insulation test voltage | RMS, $f = 50\text{ Hz}$, $t = 1\text{ min}$ RMS, $f = 50\text{ Hz}$, $t = 1\text{ sec}$ | V_{ISOL} | | 3,0 3,6 | kV kV |

Thermische Eigenschaften / Thermal properties

| | | | | | |
|--|--|-------------------|------|------------|------------------|
| Innerer Wärmewiderstand thermal resistance, junction to case | pro Modul / per Module, $\Theta = 180^\circ\text{ sin}$ pro Zweig / per arm, $\Theta = 180^\circ\text{ sin}$ pro Modul / per Module, DC pro Zweig / per arm, DC | R_{thJC} | max. | 0,085 | K/W |
| | | | max. | 0,170 | K/W |
| | | | max. | 0,082 | K/W |
| | | | max. | 0,164 | K/W |
| Übergangs-Wärmewiderstand thermal resistance, case to heatsink | pro Modul / per Module pro Zweig / per arm | R_{thCH} | max. | 0,02 | K/W |
| | | | max. | 0,04 | K/W |
| Höchstzulässige Sperrschichttemperatur maximum junction temperature | | $T_{vj\max}$ | | 125 | $^\circ\text{C}$ |
| Betriebstemperatur operating temperature | | $T_{c\text{ op}}$ | | -40...+125 | $^\circ\text{C}$ |
| Lagertemperatur storage temperature | | T_{stg} | | -40...+130 | $^\circ\text{C}$ |

Mechanische Eigenschaften / Mechanical properties

| | | | | | |
|---|--|----|------|-------------------|----------------|
| Gehäuse, siehe Anlage case, see annex | | | | Seite 4 page 4 | |
| Si-Element mit Druckkontakt Si-pellet with pressure contact | | | | | |
| Innere Isolation internal insulation | Basisisolation (Schutzklasse 1, EN61140) Basic insulation (class 1, IEC61140) | | | AIN | |
| Anzugsdrehmoment für mechanische Anschlüsse mounting torque | Toleranz / Tolerance $\pm 15\%$ | M1 | | 5 | Nm |
| Anzugsdrehmoment für elektrische Anschlüsse terminal connection torque | Toleranz / Tolerance $\pm 10\%$ | M2 | | 12 | Nm |
| Steueranschlüsse control terminals | DIN 46 244 | | | A 2,8 x 0,8 | |
| Gewicht weight | | G | typ. | 800 | g |
| Kriechstrecke creepage distance | | | | 17 | mm |
| Schwingfestigkeit vibration resistance | $f = 50\text{ Hz}$ | | | 50 | m/s^2 |
|  | file-No. | | | E 83335 | |

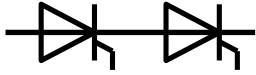

Technische Information /
technical information



Netz-Thyristor-Modul
Phase Control Thyristor Module

TT170N

Infineon Technologies Bipolar
GmbH & Co. KG

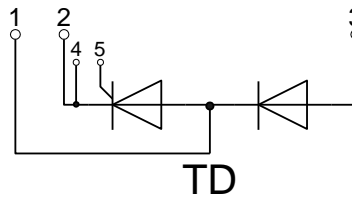
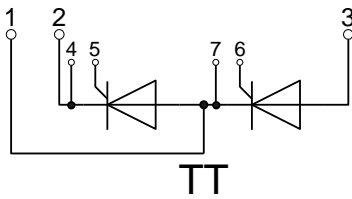
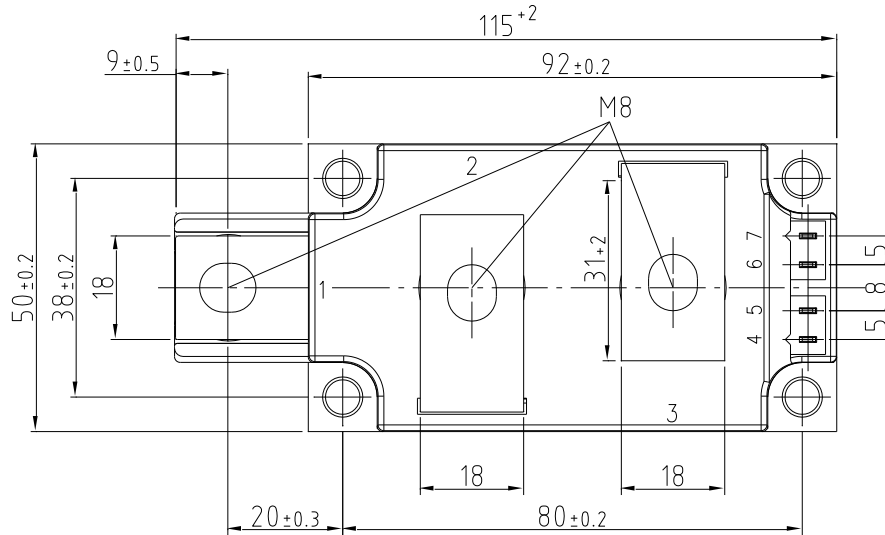
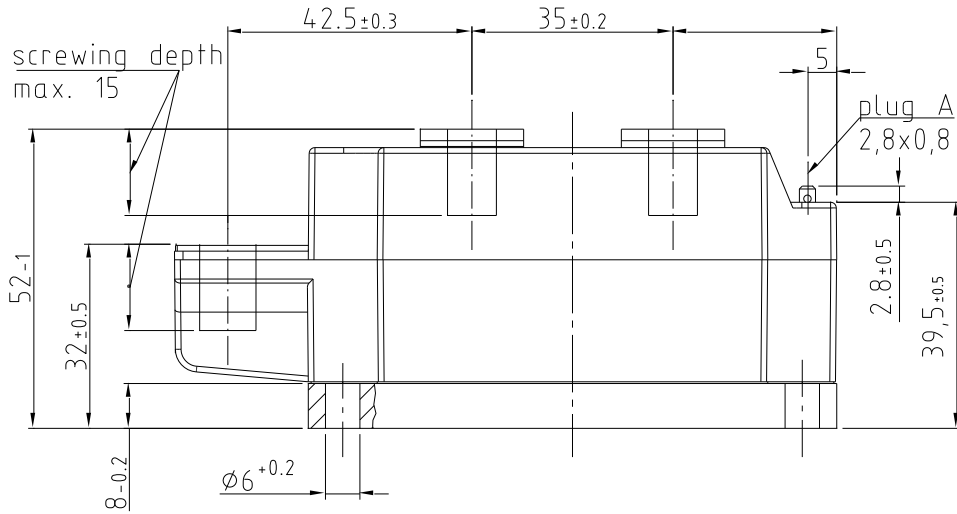

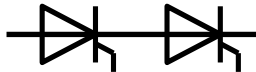

Technische Information /
technical information



Netz-Thyristor-Modul
Phase Control Thyristor Module

TT170N

Infineon Technologies Bipolar
GmbH & Co. KG

Analytische Elemente des transienten Wärmewiderstandes Z_{thJC} für DC
Analytical elements of transient thermal impedance Z_{thJC} for DC

| Pos. n | 1 | 2 | 3 | 4 | 5 | 6 | 7 |
|-----------------|--------|--------|--------|--------|--------|---|---|
| R_{thn} [K/W] | 0,0661 | 0,0552 | 0,0291 | 0,0097 | 0,0039 | | |
| τ_n [s] | 2,85 | 0,54 | 0,085 | 0,008 | 0,0008 | | |

Analytische Funktion / Analytical function:

$$Z_{thJC} = \sum_{n=1}^{n_{max}} R_{thn} \left(1 - e^{-\frac{t}{\tau_n}} \right)$$

Erhöhung des Z_{thDC} bei Sinus und Rechteckströmen mit unterschiedlichen Stromflusswinkeln Θ
Rise of Z_{thDC} for sinewave and rectangular current with different current conduction angles Θ
 $\Delta Z_{th \Theta rec} / \Delta Z_{th \Theta sin}$

| | $\Theta = 180^\circ$ | $\Theta = 120^\circ$ | $\Theta = 90^\circ$ | $\Theta = 60^\circ$ | $\Theta = 30^\circ$ |
|----------------------------------|----------------------|----------------------|---------------------|---------------------|---------------------|
| $\Delta Z_{th \Theta rec}$ [K/W] | 0,01162 | 0,01916 | 0,02517 | 0,03524 | 0,05565 |
| $\Delta Z_{th \Theta sin}$ [K/W] | 0,00630 | 0,00924 | 0,01331 | 0,02101 | 0,04129 |

$$Z_{th \Theta rec} = Z_{thDC} + \Delta Z_{th \Theta rec}$$

$$Z_{th \Theta sin} = Z_{thDC} + \Delta Z_{th \Theta sin}$$

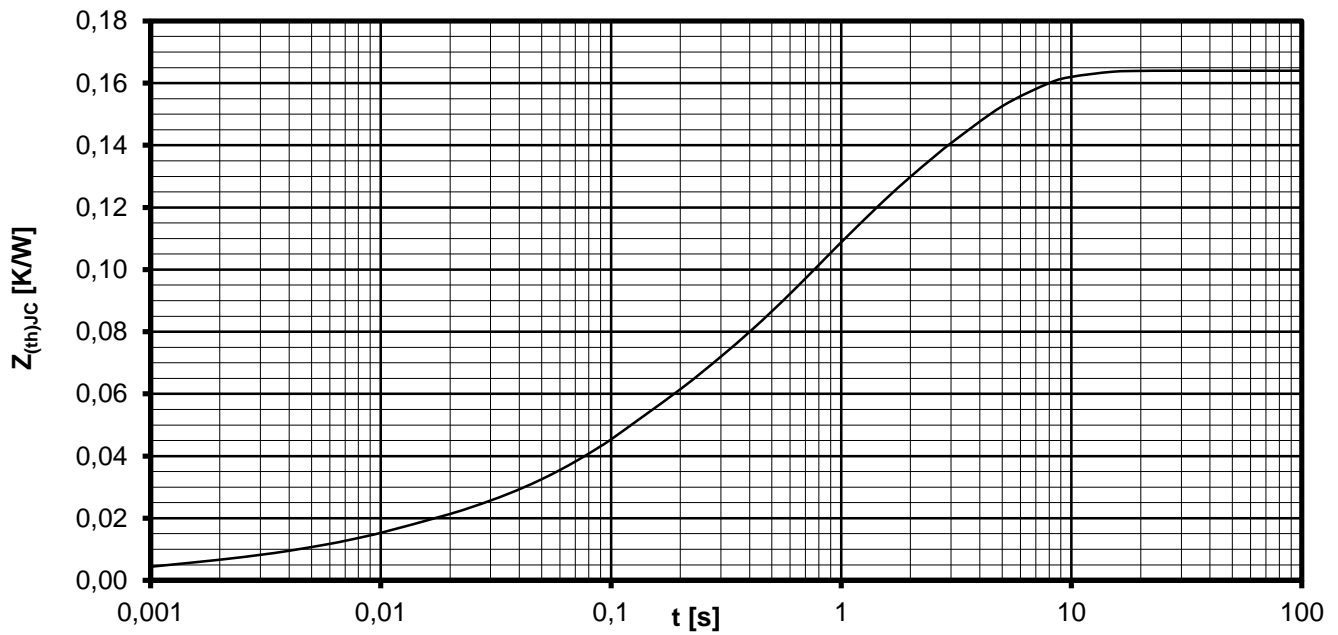
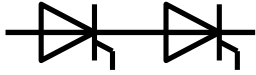

Transienter innerer Wärmewiderstand je Zweig / Transient thermal impedance per arm $Z_{thJC} = f(t)$

Parameter: Stromflußwinkel Θ / Current conduction angle Θ

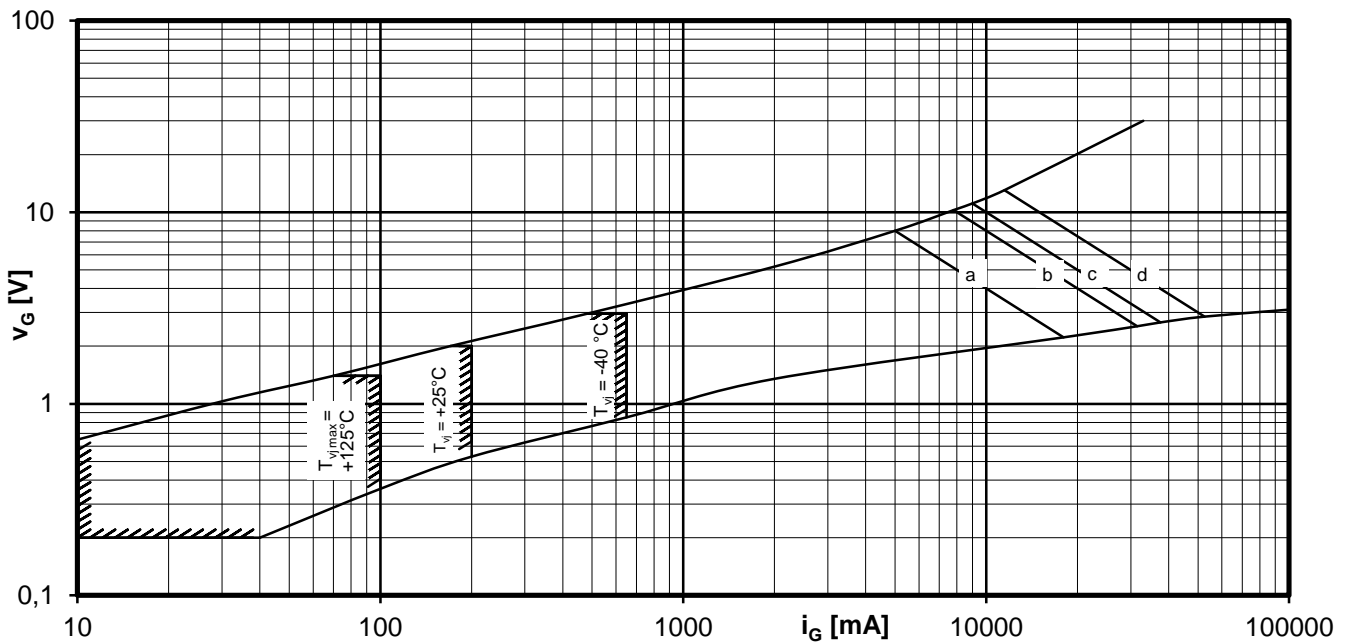

Steuercharakteristik $v_G = f(i_G)$ mit Zündbereichen für $V_D = 12\text{ V}$
Gate characteristic $v_G = f(i_G)$ with triggering area for $V_D = 12\text{ V}$

Höchstzulässige Spitzensteuerverlustleistung / Maximum rated peak gate power dissipation $P_{GM} = f(t_g)$:

a - 40W/10ms b - 80W/1ms c - 100W/0,5ms d - 150W/0,1ms

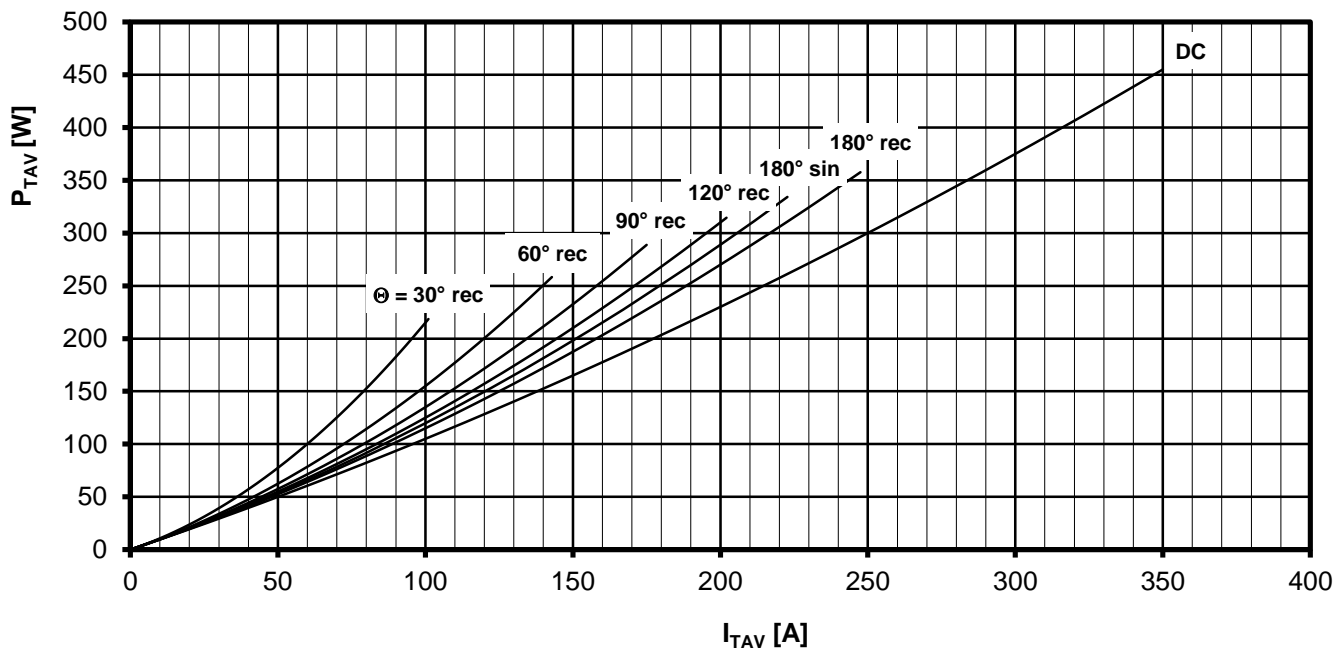
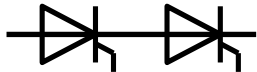

Durchlassverlustleistung je Zweig / On-state power loss per arm $P_{TAV} = f(I_{TAV})$

Strombelastung je Zweig / Current load per arm

Berechnungsgrundlage P_{TAV} (Schaltverluste gesondert berücksichtigen)
Calculation base P_{TAV} (switching losses should be considered separately)

Parameter: Stromflußwinkel / Current conduction angle Θ

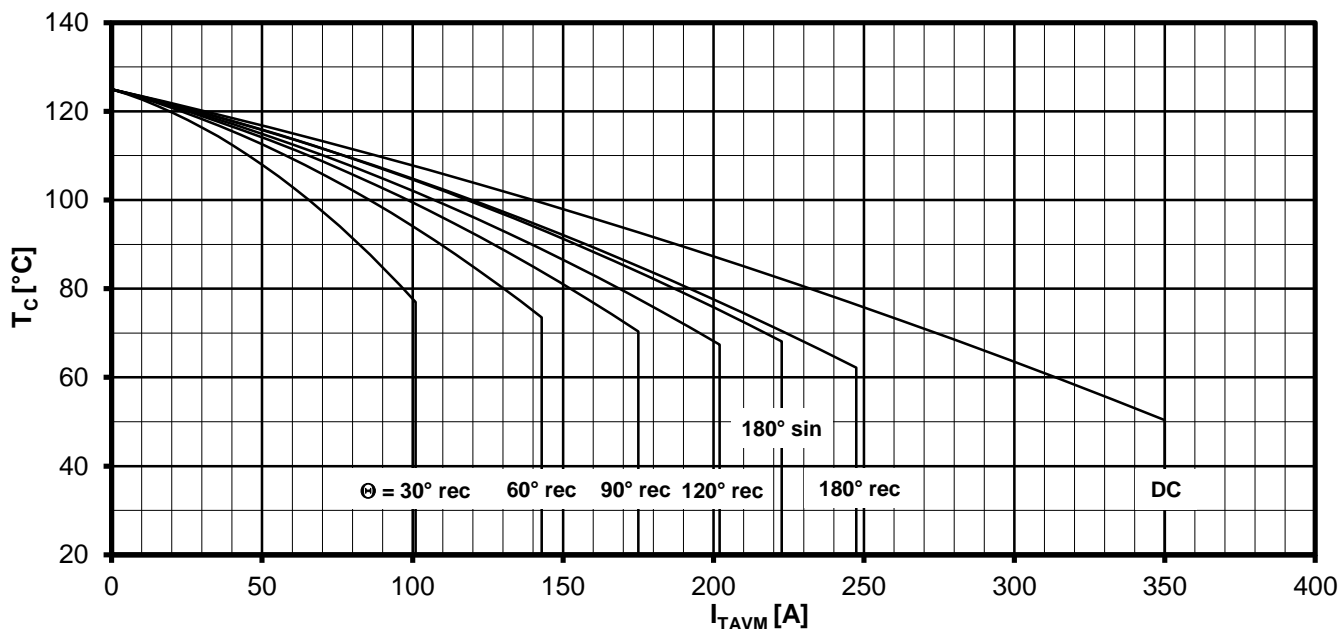

Höchstzulässige Gehäusetemperatur / Maximum allowable case temperature $T_c = f(I_{TAVM})$

Strombelastung je Zweig / Current load per arm

Berechnungsgrundlage P_{TAV} (Schaltverluste gesondert berücksichtigen)
Calculation base P_{TAV} (switching losses should be considered separately)

Parameter: Stromflußwinkel Θ / Current conduction angle Θ

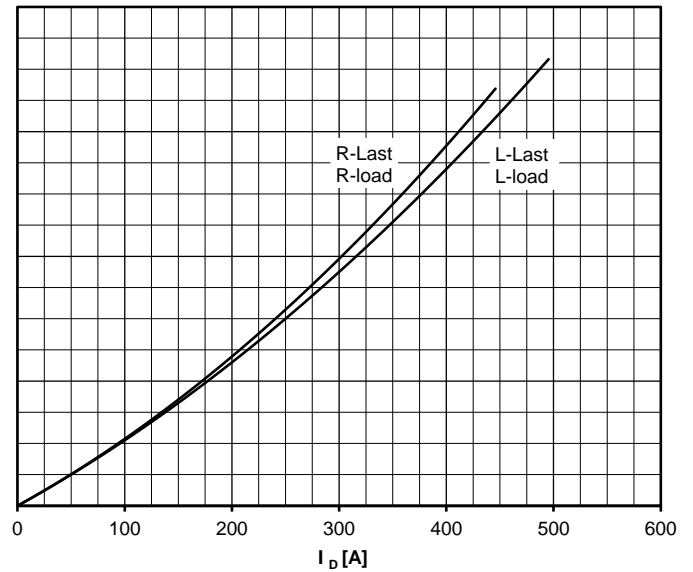
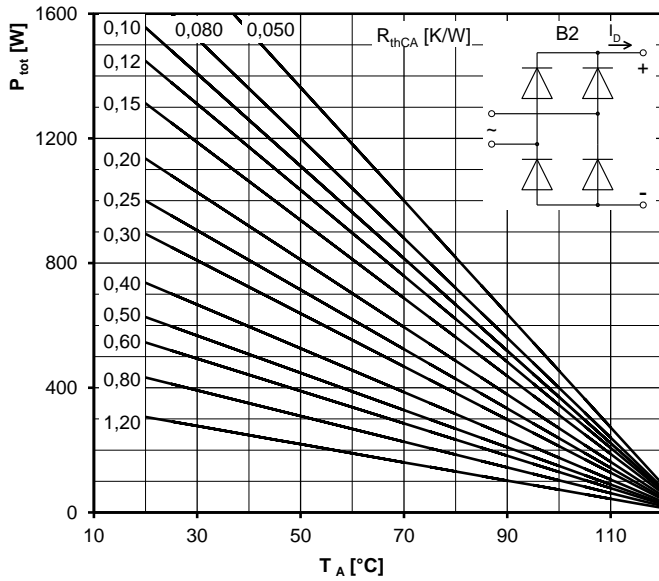
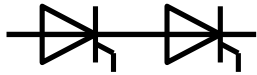

Höchstzulässiger Ausgangsstrom / Maximum rated output current I_D

B2- Zweipuls-Brückenschaltung / Two-pulse bridge circuit

Gesamtverlustleistung der Schaltung / Total power dissipation at circuit P_{tot}

Parameter:

Wärmewiderstand pro Element zwischen den Gehäusen und Umgebung /
Thermal resistance per chip cases to ambient R_{thCA}

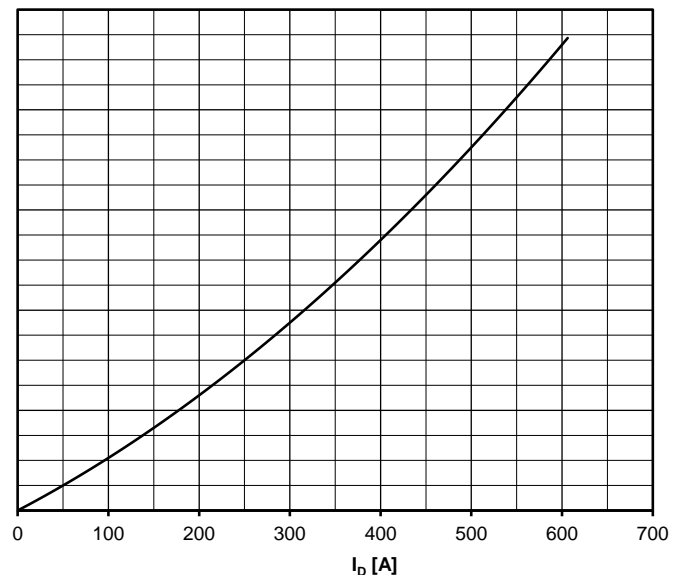
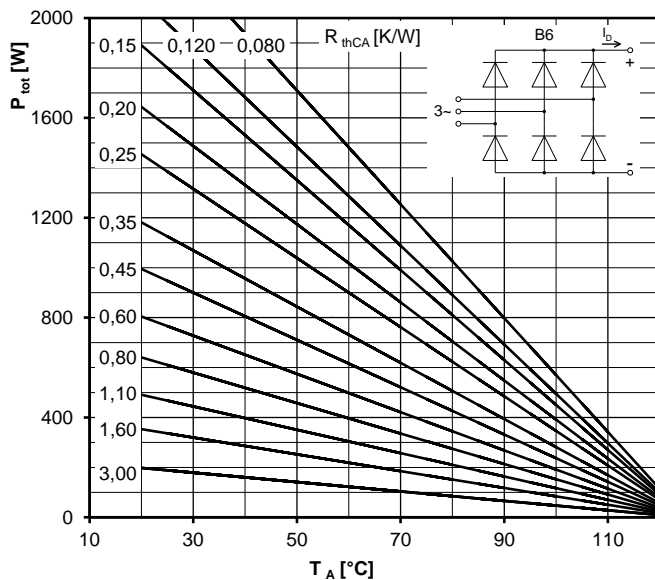

Höchstzulässiger Ausgangsstrom / Maximum rated output current I_D

B6- Sechspuls-Brückenschaltung / Six-pulse bridge circuit

Gesamtverlustleistung der Schaltung / Total power dissipation at circuit P_{tot}

Parameter:

Wärmewiderstand pro Element zwischen den Gehäusen und Umgebung /
Thermal resistance per chip cases to ambient R_{thCA}

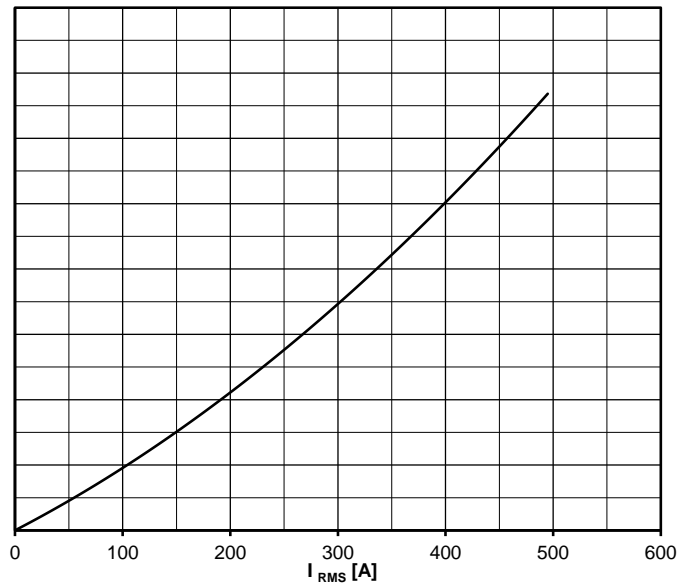
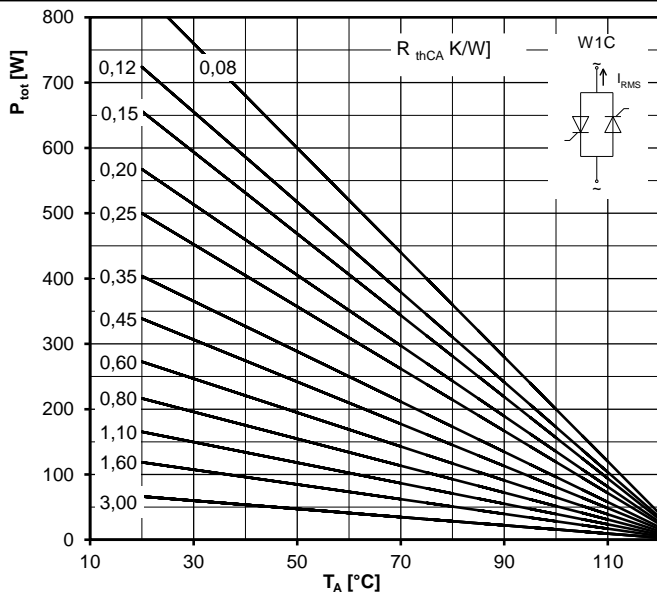
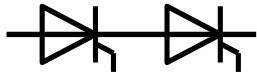

Höchstzulässiger Effektivstrom / Maximum rated RMS current I_{RMS}

W1C - Einphasen-Wechselwegschaltung / Single-phase inverse parallel circuit

Gesamtverlustleistung der Schaltung / Total power dissipation at circuit P_{tot}

Parameter:

Wärmewiderstand pro Element zwischen den Gehäusen und Umgebung /
Thermal resistance per chip cases to ambient R_{thCA}

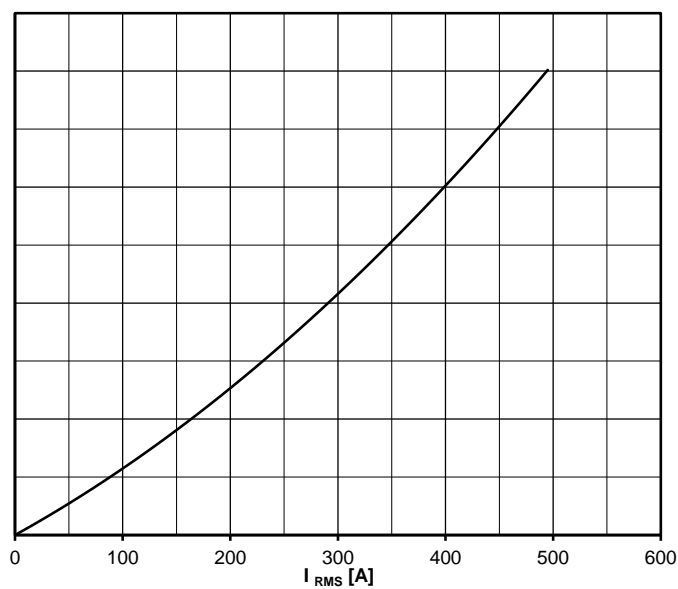
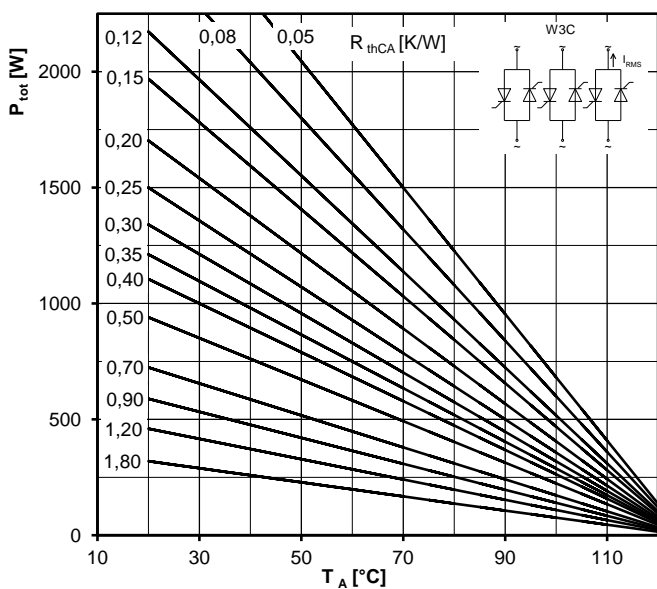

Höchstzulässiger Effektivstrom / Maximum rated RMS current I_{RMS}

W3C - Dreiphasen-Wechselwegschaltung / Three-phase inverse parallel circuit

Gesamtverlustleistung der Schaltung / Total power dissipation at circuit P_{tot}

Parameter:

Wärmewiderstand pro Element zwischen den Gehäusen und Umgebung /
Thermal resistance per chip cases to ambient R_{thCA}

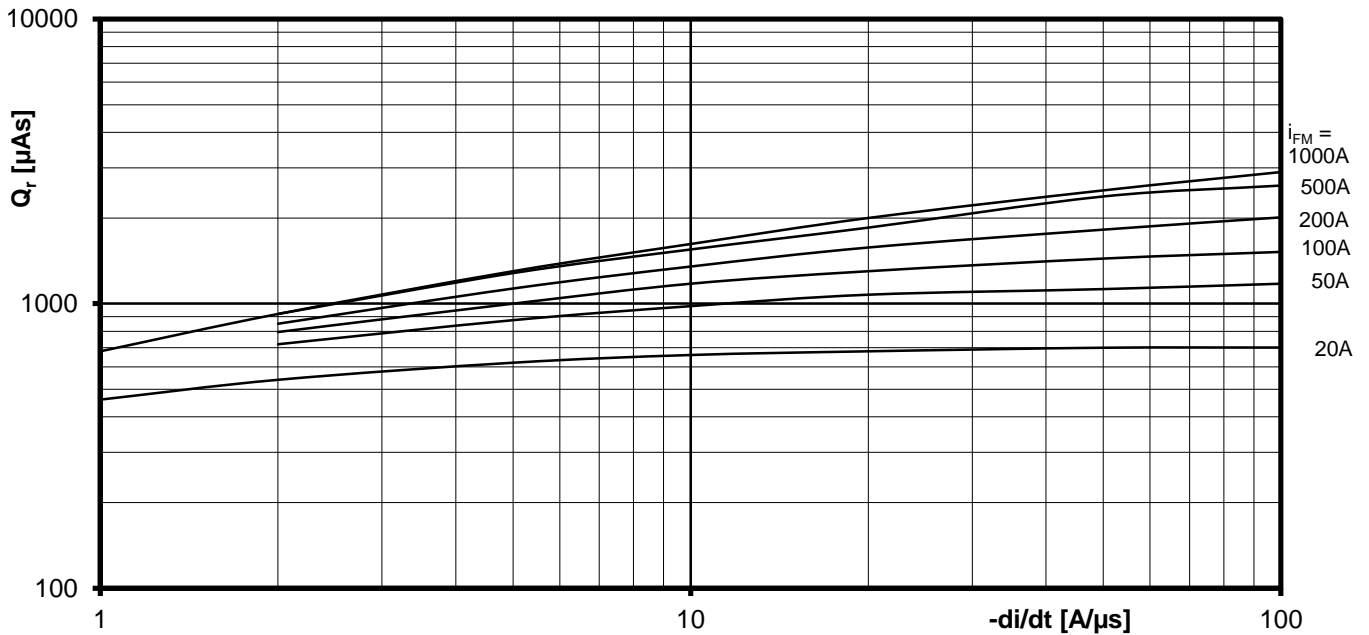
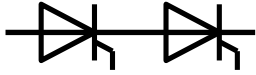

Sperrverzögerungsladung / Recovered charge $Q_r = f(-di/dt)$

$$T_{vj} = T_{vjmax}, v_R \leq 0,5 V_{RRM}, v_{RM} = 0,8 V_{RRM}$$

Parameter: Durchlaßstrom / On-state current i_{TM}

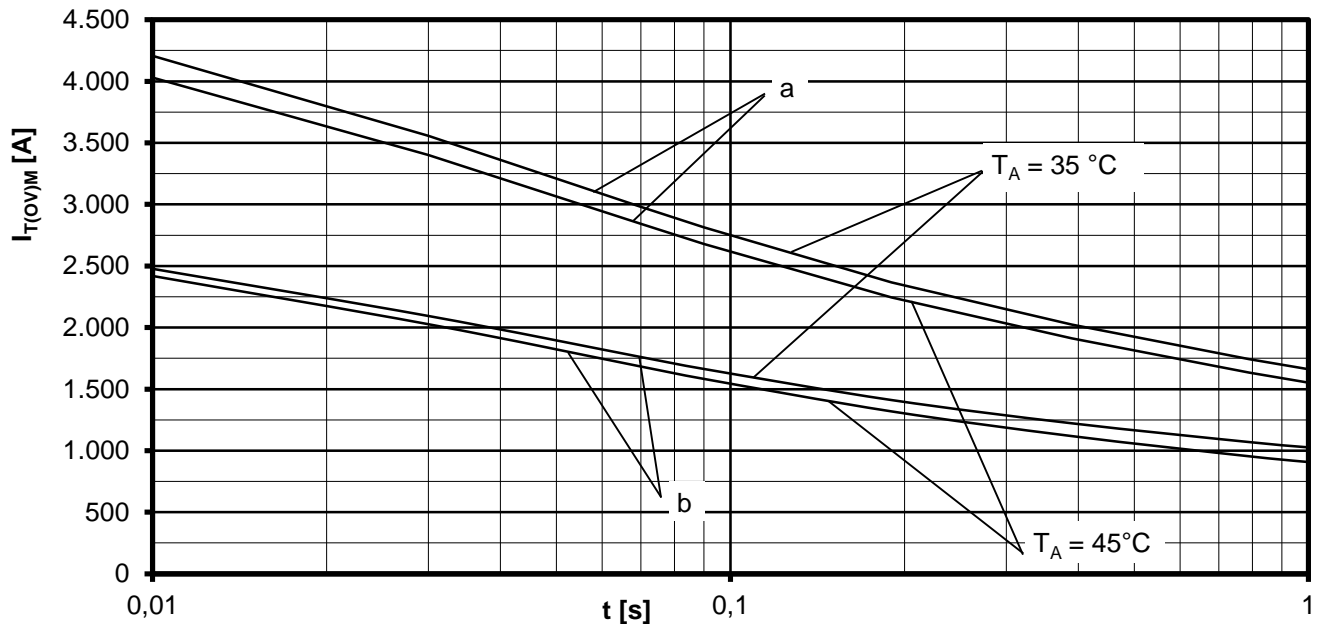

Grenzstrom / Maximum overload on-state current $I_{T(OV)M} = f(t), v_{RM} = 0,8 V_{RRM}$

a: Leerlauf / No-load conditions

b: nach Belastung mit I_{TAVM} / after load with I_{TAVM}
 $T_A = 35^\circ\text{C}$, verstärkte Luftkühlung / Forced air cooling
 $T_A = 45^\circ\text{C}$, Luftselbstkühlung / Natural air cooling

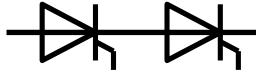

Nutzungsbedingungen

Die in diesem Produktdatenblatt enthaltenen Daten sind ausschließlich für technisch geschultes Fachpersonal bestimmt. Die Beurteilung der Eignung dieses Produktes für Ihre Anwendung sowie die Beurteilung der Vollständigkeit der bereitgestellten Produktdaten für diese Anwendung obliegt Ihnen bzw. Ihren technischen Abteilungen.

In diesem Produktdatenblatt werden diejenigen Merkmale beschrieben, für die wir eine liefervertragliche Gewährleistung übernehmen. Eine solche Gewährleistung richtet sich ausschließlich nach Maßgabe der im jeweiligen Liefervertrag enthaltenen Bestimmungen. Garantien jeglicher Art werden für das Produkt und dessen Eigenschaften keinesfalls übernommen.

Sollten Sie von uns Produktinformationen benötigen, die über den Inhalt dieses Produktdatenblatts hinausgehen und insbesondere eine spezifische Verwendung und den Einsatz dieses Produktes betreffen, setzen Sie sich bitte mit dem für Sie zuständigen Vertriebsbüro in Verbindung. Für Interessenten halten wir Application Notes bereit.

Aufgrund der technischen Anforderungen könnte unser Produkt gesundheitsgefährdende Substanzen enthalten. Bei Rückfragen zu den in diesem Produkt jeweils enthaltenen Substanzen setzen Sie sich bitte ebenfalls mit dem für Sie zuständigen Vertriebsbüro in Verbindung.

Sollten Sie beabsichtigen, das Produkt in gesundheits- oder lebensgefährdenden oder lebenserhaltenden Anwendungsbereichen einzusetzen, bitten wir um Mitteilung. Wir weisen darauf hin, dass wir für diese Fälle

- die gemeinsame Durchführung eines Risiko- und Qualitätsassessments;
- den Abschluss von speziellen Qualitätssicherungsvereinbarungen;
- die gemeinsame Einführung von Maßnahmen einer laufenden Produktbeobachtung dringend empfehlen und gegebenenfalls die Belieferung von der Umsetzung solcher Maßnahmen abhängig machen.

Soweit erforderlich, bitten wir Sie, entsprechende Hinweise an Ihre Kunden zu geben.

Inhaltliche Änderungen dieses Produktdatenblatts bleiben vorbehalten.

Terms & Conditions of usage

The product data contained in this product data sheet is exclusively intended for technically trained staff. You and your technical departments will have to evaluate the suitability of the product for the intended application and the completeness of the product data with respect to such application.

This product data sheet is describing the specifications of this product for which a warranty is granted. Any such warranty is granted exclusively pursuant the terms and conditions of the supply agreement. There will be no guarantee of any kind for the product and its specifications.

Should you require product information in excess of the data given in this product data sheet or which concerns the specific application of our product, please contact the sales office, which is responsible for you. For those that are specifically interested we may provide application notes.

Due to technical requirements our product may contain dangerous substances. For information on the types in question please contact the sales office, which is responsible for you.

Should you intend to use the Product in health or live endangering or life support applications, please notify. Please note, that for any such applications we urgently recommend



- to perform joint Risk and Quality Assessments;
- the conclusion of Quality Agreements;
- to establish joint measures of an ongoing product survey, and that we may make delivery depended on the realization of any such measures.

If and to the extent necessary, please forward equivalent notices to your customers.

Changes of this product data sheet are reserved.

Looking for pricing, stock, or lifecycle information?

Click below to explore more details on WIN SOURCE:

-  [View TD170N12KOFHPSA1 on WIN SOURCE](#)
-  [Infineon Technologies Information](#)

Optimize Your Supply Chain with WIN SOURCE Solutions

-  Global Sourcing Solution
-  Obsolete Management
-  Cost Control Management
-  Shortage Management
-  Alternative Solution
-  Excess Inventory Management