



**THE DATASHEET OF
QSH-030-01-H-D-A**



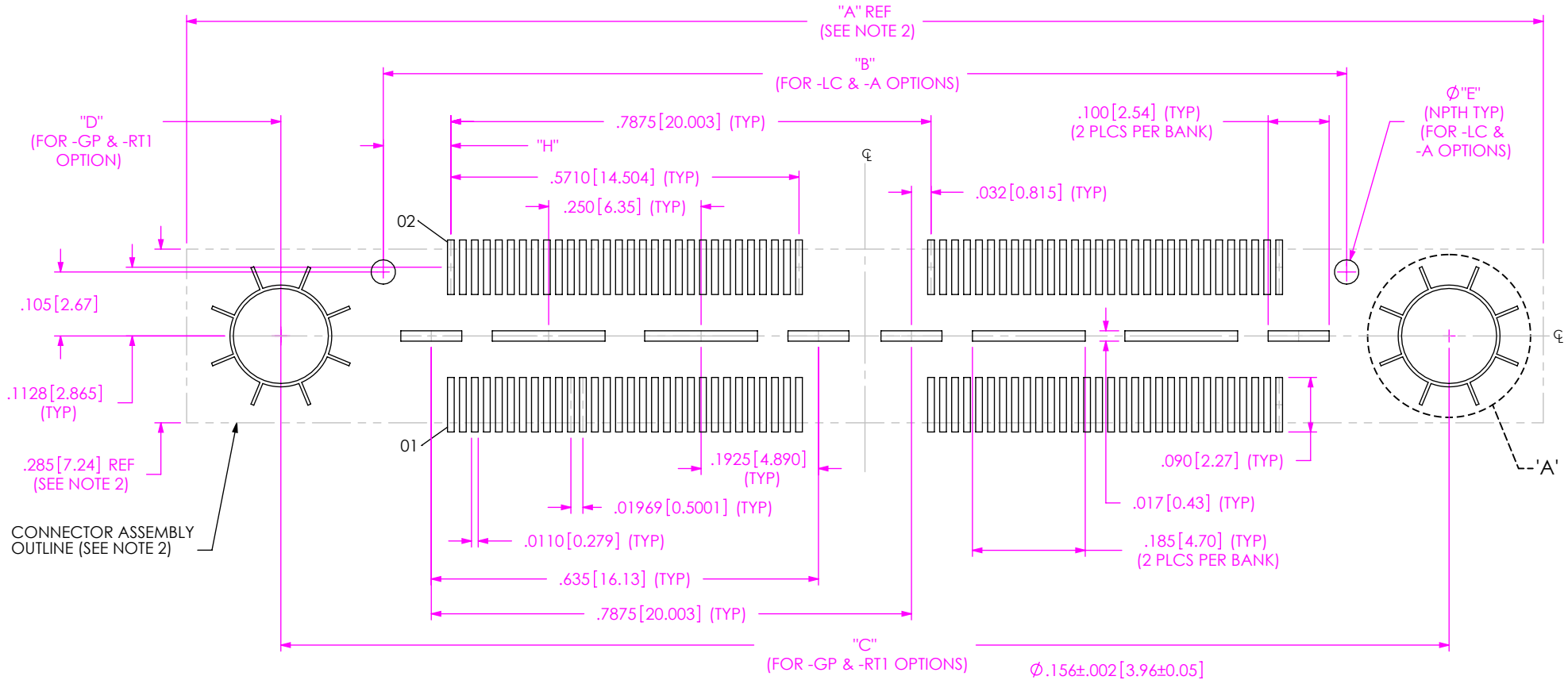
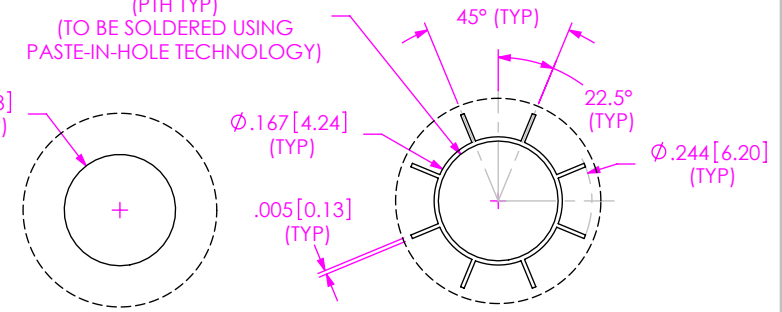

FIG 1
FOOTPRINT FOR QSH-060-01-X-D-XXX SHOWN

- NOTES:
 1. ALL DIMENSIONS ARE SYMMETRIC ABOUT THE CENTERLINE.
 2. CONNECTOR ENVELOPE DIMENSIONS, OTHER COMPONENTS PLACED ON PCB SHALL AVOID THIS ZONE.
 3. FOR -SD/-DS OPTIONS, PLEASE REFER TO THE "QXXX WITH SCREW-DOWN OPTIONS" APPLICATION DRAWING.

OPTION	"D"
-GP	.221 [5.61]
-RT1	.279 [7.08]

OPTION	"E"
-LC	.047 [1.19]
-A	.040 [1.02]



-GP OPTION:
DETAIL 'A'
SCALE 4:1

-RT1 OPTION:
DETAIL 'A'
SCALE 4:1

No OF POS	"A"				"B"		"C"		"H"
	-LC & -A	-FL	-GP	-RT1	-LC & -A	-GP	-RT1		
-030	.839 [21.31]	.803 [20.38]	1.216 [30.89]	1.438 [36.53]	.793 [20.13]	1.013 [25.73]	1.129 [28.68]	.1118 [2.84]	
-060	1.627 [41.31]	1.590 [40.39]	2.004 [50.89]	2.226 [56.53]	1.580 [40.13]	1.801 [45.73]	1.917 [48.68]	.1108 [2.81]	
-090	2.417 [61.38]	2.378 [60.39]	2.791 [70.89]	3.013 [76.53]	2.368 [60.13]	2.588 [65.74]	2.704 [68.68]	.1108 [2.81]	
-120	3.204 [81.38]	3.165 [80.39]	3.579 [90.89]	N/A	3.155 [80.14]	3.376 [85.74]	N/A	.1108 [2.81]	
-150	3.991 [101.37]	3.953 [100.39]	4.366 [110.90]	N/A	3.943 [100.14]	4.163 [105.74]	N/A	.1108 [2.81]	

PROPRIETARY NOTE
 THIS DOCUMENT CONTAINS INFORMATION CONFIDENTIAL AND PROPRIETARY TO SAMTEC, INC. AND SHALL NOT BE REPRODUCED OR TRANSFERRED TO OTHER DOCUMENTS OR DISCLOSED TO OTHERS OR USED FOR ANY PURPOSE OTHER THAN THAT WHICH IT WAS OBTAINED WITHOUT THE EXPRESSED WRITTEN CONSENT OF SAMTEC, INC.

samtec
 520 PARK EAST BLVD, NEW ALBANY, IN 47150
 PHONE: 812-944-6733 FAX: 812-948-5047
 e-Mail info@SAMTEC.com code 55322

NOTES:
1. STENCIL TO BE .0060[.152] THICK.

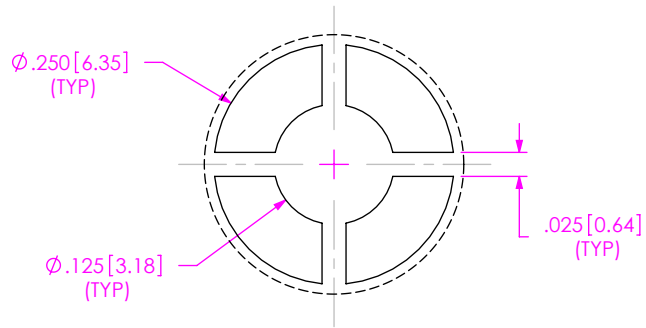
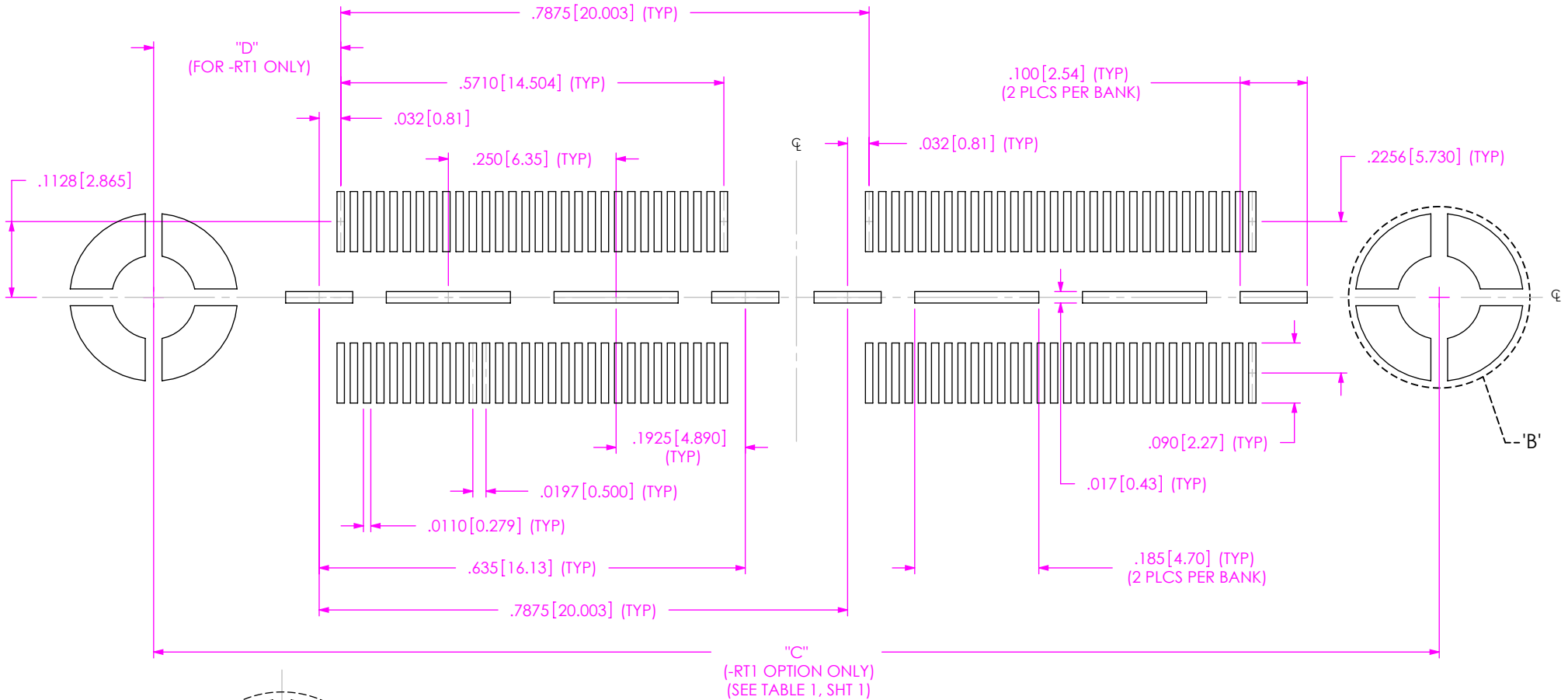

-RT1 OPTION ONLY:
DETAIL 'B'
SCALE 5 : 1

FIG 2
STENCIL FOR QSH-060-01-X-D-XXX SHOWN

PROPRIETARY NOTE
THIS DOCUMENT CONTAINS INFORMATION CONFIDENTIAL AND PROPRIETARY TO SAMTEC, INC. AND SHALL NOT BE REPRODUCED OR TRANSFERRED TO OTHER DOCUMENTS OR DISCLOSED TO OTHERS OR USED FOR ANY PURPOSE OTHER THAN THAT WHICH IT WAS OBTAINED WITHOUT THE EXPRESSED WRITTEN CONSENT OF SAMTEC, INC.



520 PARK EAST BLVD, NEW ALBANY, IN 47150
PHONE: 812-944-6733 FAX: 812-948-5047
e-Mail info@SAMTEC.com code 55322

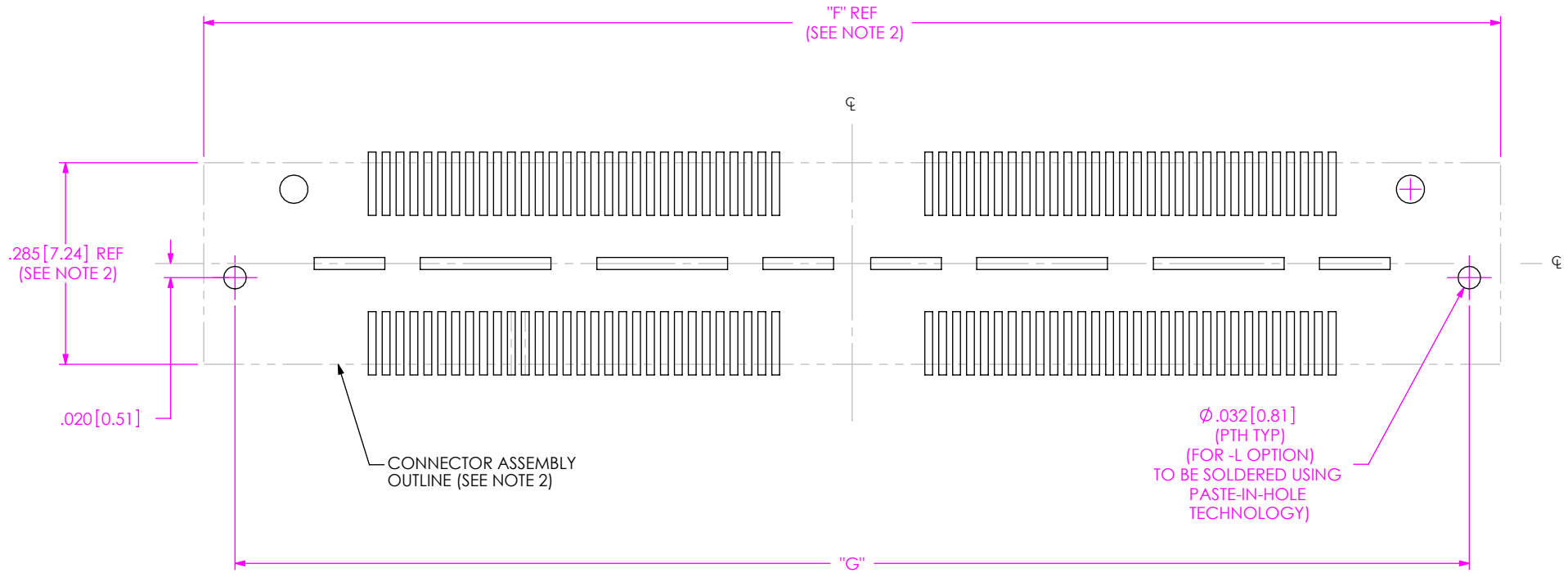

FIG 3
-L OPTION
FOOTPRINT FOR QSH-060-01-X-D-A-L SHOWN
(SAME AS FIG 1, EXCEPT AS SHOWN)

TABLE 4		
No OF POS	"F"	"G"
-030	1.048 [26.62]	.959 [24.36]
-060	1.836 [46.62]	1.747 [44.36]
-090	2.623 [66.62]	2.534 [64.36]
-120	3.411 [86.63]	3.322 [84.37]
150	4.198 [106.63]	4.109 [104.37]

PROPRIETARY NOTE
THIS DOCUMENT CONTAINS INFORMATION CONFIDENTIAL AND PROPRIETARY TO SAMTEC, INC. AND SHALL NOT BE REPRODUCED OR TRANSFERRED TO OTHER DOCUMENTS OR DISCLOSED TO OTHERS OR USED FOR ANY PURPOSE OTHER THAN THAT WHICH IT WAS OBTAINED WITHOUT THE EXPRESSED WRITTEN CONSENT OF SAMTEC, INC.



520 PARK EAST BLVD, NEW ALBANY, IN 47150
PHONE: 812-944-6733 FAX: 812-948-5047
e-Mail info@SAMTEC.com code 55322

NOTES:
1. STENCIL TO BE .0060[.152] THICK

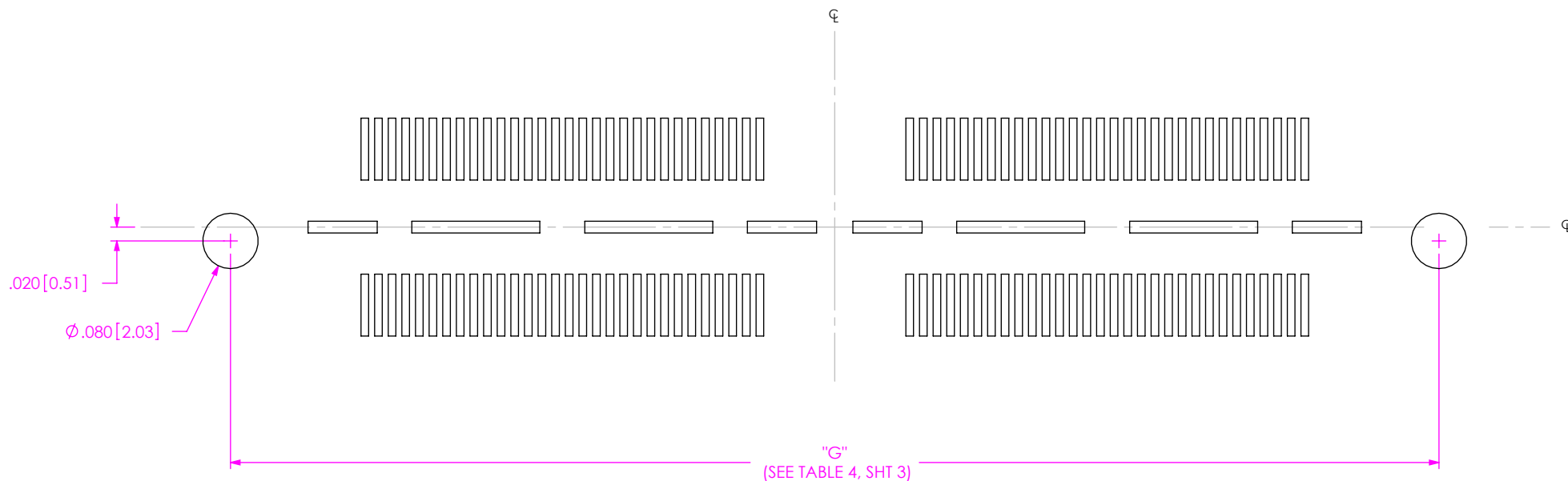

FIG 4
-L OPTION
STENCIL FOR QSH-060-01-X-D-A-L SHOWN
(SAME AS FIG 2, EXCEPT AS SHOWN)



PROPRIETARY NOTE
THIS DOCUMENT CONTAINS INFORMATION
CONFIDENTIAL AND PROPRIETARY TO
SAMTEC, INC. AND SHALL NOT BE REPRODUCED
OR TRANSFERRED TO OTHER DOCUMENTS OR
DISCLOSED TO OTHERS OR USED FOR ANY
PURPOSE OTHER THAN THAT WHICH IT WAS
OBTAINED WITHOUT THE EXPRESSED WRITTEN
CONSENT OF SAMTEC, INC.



520 PARK EAST BLVD, NEW ALBANY, IN 47150
PHONE: 812-944-6733 FAX: 812-948-5047
e-Mail info@SAMTEC.com code 55322

Looking for pricing, stock, or lifecycle information?

Click below to explore more details on WIN SOURCE:

-  [View QSH-030-01-H-D-A on WIN SOURCE](#)
-  [Samtec Inc. Information](#)

Optimize Your Supply Chain with WIN SOURCE Solutions

-  Global Sourcing Solution
-  Obsolete Management
-  Cost Control Management
-  Shortage Management
-  Alternative Solution
-  Excess Inventory Management