



**THE DATASHEET OF
XF2J142411AR100BYOMZ**



XF2J

ZIF Slide-locking Connector (0.5-mm Pitch)

For FPC/FFC

Top-entry ZIF Connector.

- Low on-board height of only 4.15 mm.
- Correspond for auto-mounting, secured the pick-and-place on top of the connector.
- Models with reverse terminal type also available.
- Applicable FPC/FFC thickness of 0.3 mm (Gold-plated type).

RoHS compliant

■ Ratings and Specifications

Rated current	0.5 A AC/DC
Rated voltage	50 V AC/DC
Contact resistance	30 mΩ max. (at 20 mV DC max., 100 mA max.)
Insulation resistance	100 MΩ min. (at 250 V DC)
Dielectric strength	250 V AC for 1 min. (leakage current: 1 mA max.)
Insertion durability	30 times
Ambient operating temperature	-30 to 85 °C (With no icing or condensation)

■ Materials and Finish

Housing	PA46 resin (UL94 V-0)/natural
Slider	LCP resin (UL94 V-0)/black
Contacts	Spring copper alloy/nickel substrate (2 μm), Gold-plated contacts (0.15 μm)
Hold-down	Copper alloy/tin-plated (1.5 μm)



■ Dimensions

(Unit: mm)

XF2J-□□24-1□A

Recommended FPC/FFC Dimensions

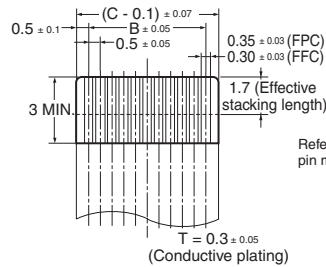

(Standard terminal type)

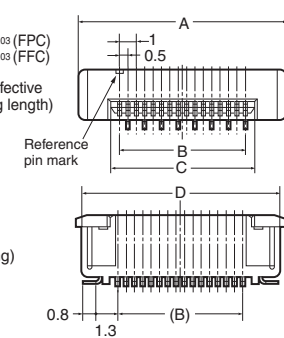

(Reverse terminal type)

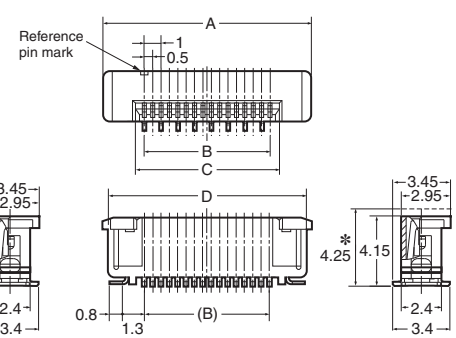
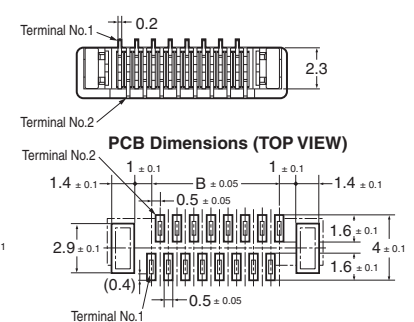
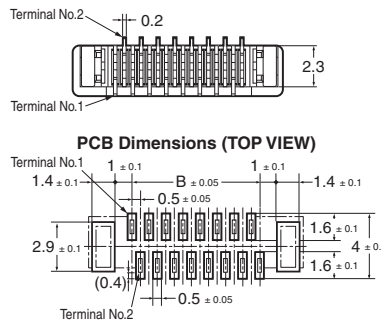

Table of Dimensions

Pins #1	Model		A	B	C	D
	Standard terminal type	Reverse terminal type				
6	XF2J-0624-11A	XF2J-0624-12A	7.5	2.5	3.6	6.9
8	XF2J-0824-11A	XF2J-0824-12A	8.5	3.5	4.6	7.9
10	XF2J-1024-11A	XF2J-1024-12A	9.5	4.5	5.6	8.9
12	XF2J-1224-11A	XF2J-1224-12A	10.5	5.5	6.6	9.9
14	XF2J-1424-11A	-	11.5	6.5	7.6	10.9
16	XF2J-1624-11A	XF2J-1624-12A	12.5	7.5	8.6	11.9
18	XF2J-1824-11A	XF2J-1824-12A	13.5	8.5	9.6	12.9
20	XF2J-2024-11A	XF2J-2024-12A	14.5	9.5	10.6	13.9
22	XF2J-2224-11A	XF2J-2224-12A	15.5	10.5	11.6	14.9
24	XF2J-2424-11A	XF2J-2424-12A	16.5	11.5	12.6	15.9
26	XF2J-2624-11A	-	17.5	12.5	13.6	16.9
28	XF2J-2824-11A	-	18.5	13.5	14.6	17.9
30	XF2J-3024-11A	-	19.5	14.5	15.6	18.9
40	-	XF2J-4024-12A	25.1	19.5	20.6	24.3



* Dotted lines indicate the shape and dimensions of the XF2J-4024-12A connectors.

■ Ordering Information

1000pcs per reel

Pins ^{*1}	Model		Pins ^{*1}	Model		Pins ^{*1}	Model		Quantity per reel (unit) ^{*2}
	Standard terminal type	Reverse terminal type		Standard terminal type	Reverse terminal type		Standard terminal type	Reverse terminal type	
6	XF2J-0624-11A	XF2J-0624-12A	16	XF2J-1624-11A	XF2J-1624-12A	26	XF2J-2624-11A	-	1,000
8	XF2J-0824-11A	XF2J-0824-12A	18	XF2J-1824-11A	XF2J-1824-12A	28	XF2J-2824-11A	-	
10	XF2J-1024-11A	XF2J-1024-12A	20	XF2J-2024-11A	XF2J-2024-12A	30	XF2J-3024-11A	-	
12	XF2J-1224-11A	XF2J-1224-12A	22	XF2J-2224-11A	XF2J-2224-12A	40	-	XF2J-4024-12A	
14	XF2J-1424-11A	-	24	XF2J-2424-11A	XF2J-2424-12A				

100pcs per reel

Pins ^{*1}	Model		Pins ^{*1}	Model		Pins ^{*1}	Model		Quantity per reel (unit) ^{*2}
	Standard terminal type	Reverse terminal type		Standard terminal type	Reverse terminal type		Standard terminal type	Reverse terminal type	
6	XF2J-0624-11A-R100	XF2J-0624-12A-R100	16	XF2J-1624-11A-R100	XF2J-1624-12A-R100	26	XF2J-2624-11A-R100	-	100
8	XF2J-0824-11A-R100	XF2J-0824-12A-R100	18	XF2J-1824-11A-R100	XF2J-1824-12A-R100	28	XF2J-2824-11A-R100	-	
10	XF2J-1024-11A-R100	XF2J-1024-12A-R100	20	XF2J-2024-11A-R100	XF2J-2024-12A-R100	30	XF2J-3024-11A-R100	-	
12	XF2J-1224-11A-R100	XF2J-1224-12A-R100	22	XF2J-2224-11A-R100	XF2J-2224-12A-R100	40	-	XF2J-4024-12A-R100	
14	XF2J-1424-11A-R100	-	24	XF2J-2424-11A-R100	XF2J-2424-12A-R100				

*1. Please consult your OMRON representative for available pin count.

*2. Please order by integer multiple of the quantity per reel.

Looking for pricing, stock, or lifecycle information?

Click below to explore more details on WIN SOURCE:

-  [View XF2J142411AR100BYOMZ on WIN SOURCE](#)
-  [Omron Information](#)

Optimize Your Supply Chain with WIN SOURCE Solutions

-  Global Sourcing Solution
-  Obsolete Management
-  Cost Control Management
-  Shortage Management
-  Alternative Solution
-  Excess Inventory Management