

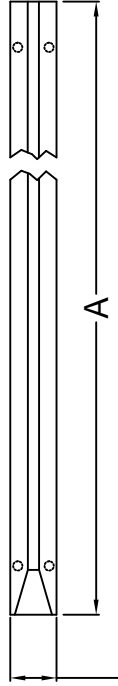

**THE DATASHEET OF
SSD-250-102**

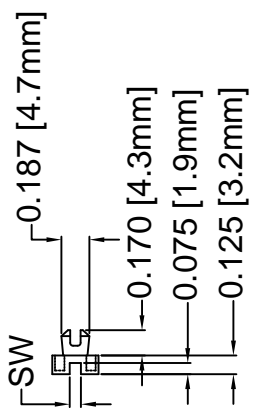

REV.	
H	Engineering Release
J	Updated Material No



0.31 [7.9mm]

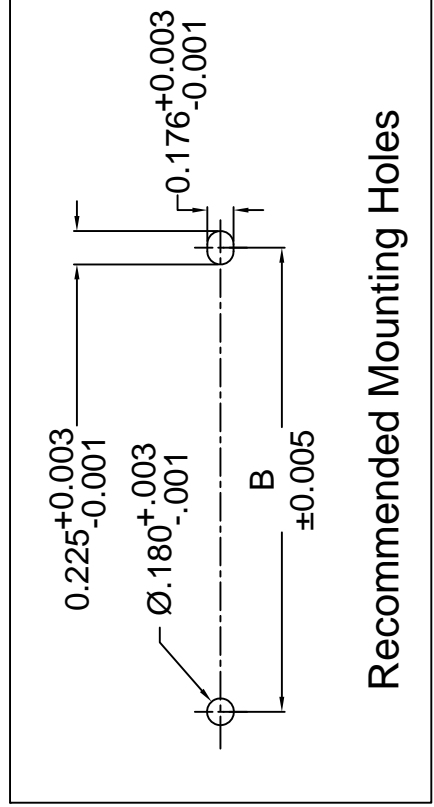
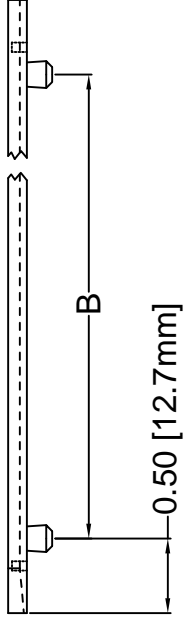

PART NO.	
SSD-250	SSD-250-102
SSD-300	SSD-300-102
SSD-350	SSD-350-102
SSD-400	SSD-400-102
SSD-450 3X	-
SSD-450	SSD-450-102
SSD-500	SSD-500-102
SSD-550	SSD-550-102
SSD-600	SSD-600-102
SSD-650	SSD-650-102
SSD-700	SSD-700-102
SSD-750	SSD-750-102
SSD-800	SSD-800-102
SW=0.075 (1.9)	SW=0.102 (2.6)

STANDARD TOLERANCES (UNLESS OTHERWISE SPECIFIED)	
DECIMALS	ANGLES
.X $\pm .1$	X°
.XX $\pm .01$	
.XXX $\pm .005$	
DESIGNED BY:	DATE:
David Green	11/2
CHECKED BY:	DATE:
M. Chen	11/2

3. ALL DIMENSIONS IN INCHES, UNLESS OTHERWISE SPECIFIED.
2. MATERIAL: NYLON 6/6, 94V-2, NATURAL.
1. GENERAL SPECIFICATIONS: BIVAR MOLDED COMPONENT SPECIFICATION BV00-E101.

Looking for pricing, stock, or lifecycle information?

Click below to explore more details on WIN SOURCE:

 [View SSD-250-102 on WIN SOURCE](#)

 [Bivar Inc. Information](#)

Optimize Your Supply Chain with WIN SOURCE Solutions

-  Global Sourcing Solution
-  Obsolete Management
-  Cost Control Management
-  Shortage Management
-  Alternative Solution
-  Excess Inventory Management