



THE DATASHEET OF SST3I-C





The Future of Analog IC Technology®

MP2678

Single-Cell, Li-Ion Battery Charger Protection Circuit with Low-Dropout Mode

DESCRIPTION

The MP2678 is a high-performance, single-cell Li-ion and Li-polymer battery charger protection circuit with low-dropout mode. Its integrated high-voltage input protection allows the IC to tolerate input surges up to 30V.

The device operates similar to a linear regulator, and maintains a regulated 5V output at input voltages up to the over-voltage protection (OVP) threshold (10.4V).

Full protection features include input OVP, MPS's proprietary battery OVP, and over-current protection (OCP). If a fault event occurs, the internal N-channel MOSFET turns off to disconnect the charging circuit from the input. Fault indication is also provided to indicate when a fault event occurs.

Thermal monitoring and thermal shutdown are provided to guarantee safe operation. The MP2678 monitors the internal temperature. If the die temperature exceeds the thermal shutdown threshold (typically 140°C), then the N-channel MOSFET bridging the input and output turns off.

The MP2678 requires a minimal number of standard, external components, and is available in a QFN-8 (2mmx2mm) package.

FEATURES

- Input Surge Up to 30V
- 5V Regulated Output
- Input Over-Voltage Protection (OVP)
- MPS Proprietary Battery OVP
- Output Short-Circuit Protection (SCP)
- Soft-Stop to Prevent Voltage Spikes
- Up to 1.7A Load Current
- Thermal Monitoring
- Thermal Shutdown
- Enable (EN) Function
- Fault Indication
- Available in a QFN-8 (2mmx2mm) Package

APPLICATIONS

- Cell Phones
- Smartphones
- Personal Digital Assistants (PDAs)
- MP3 Players
- Digital Cameras
- Low-Power Handheld Devices

All MPS parts are lead-free, halogen-free, and adhere to the RoHS directive. For MPS green status, please visit the MPS website under Quality Assurance. "MPS", the MPS logo, and "Simple, Easy Solutions" are trademarks of Monolithic Power Systems, Inc. or its subsidiaries.

TYPICAL APPLICATION CIRCUIT

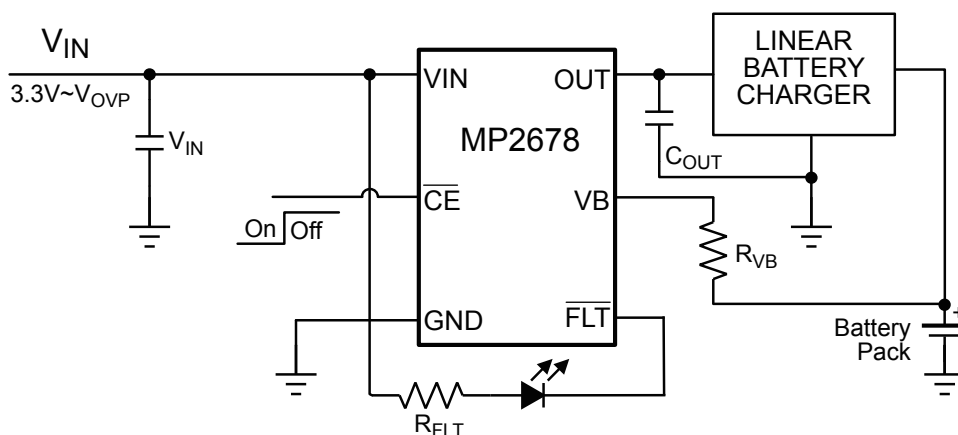

ORDERING INFORMATION

Part Number*	OVP Voltage	Package	Top Marking	Free Air Temperature (T _A)
MP2678EG	10.4V	QFN-8 (2mmx2mm)	AK	-20°C to +85°C

For Tape & Reel, add suffix -Z (e.g. MP2678EG-Z).

For RoHS-compliant packaging, add suffix -LF-Z (e.g. MP2678EG-LF-Z).

PACKAGE REFERENCE

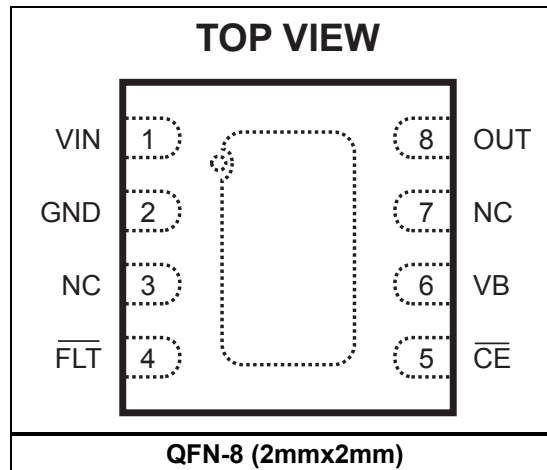

PIN FUNCTIONS

Pin #	Name	Description
1	VIN	Input power source. The VIN pin can withstand up to a 30V input.
2	GND Exposed Pad	System ground. Connect the exposed pad to the GND plane for optimized thermal performance.
3, 7	NC	No connect. Float NC.
4	$\overline{\text{FLT}}$	Open-drain output. If a fault event occurs, the $\overline{\text{FLT}}$ pin goes low.
5	$\overline{\text{CE}}$	Active-low enable (EN). Pull the $\overline{\text{CE}}$ pin below 0.4V to turn the IC on; pull $\overline{\text{CE}}$ above 1.5V to turn it off.
6	VB	Battery voltage (V_{BATT}) monitoring input. Connect the VB pin to the battery pack's positive terminal via an isolation resistor.
8	OUT	Output. The OUT pin is the input pin of the protected charger.

ABSOLUTE MAXIMUM RATINGS ⁽¹⁾

V _{IN} to GND	-0.3V to +30V
V _{OUT} to GND	-0.3V to +7V
All other pins to GND	-0.3V to +7V
Continuous power dissipation (T _A = 25°C) ⁽²⁾	1.25W
Junction temperature	-20°C to +150°C
Storage temperature	-65°C to +150°C

ESD Ratings ⁽³⁾

HBM (human-body model)	2kV
MM (machine model)	200V

Recommended Operating Conditions ⁽⁴⁾

Supply input voltage (V _{IN})	3.3V to V _{OVP}
Output current (I _{OUT})	1.5A
Maximum junction temp (T _J)	125°C

Thermal Resistance ⁽⁵⁾	θ_{JA}	θ_{JC}
QFN-8 (2mmx2mm)	80	60 ... °C/W

Notes:

- 1) Exceeding these ratings may damage the device.
- 2) The maximum allowable power dissipation is a function of the maximum junction temperature T_J (MAX), the junction-to-ambient thermal resistance θ_{JA}, and the ambient temperature T_A. The maximum allowable continuous power dissipation at any ambient temperature is calculated by P_D (MAX) = (T_J (MAX) - T_A) / θ_{JA}. Exceeding the maximum allowable power dissipation can cause excessive die temperature, and the device may go into thermal shutdown. Internal thermal shutdown circuitry protects the device from permanent damage.
- 3) Devices are ESD sensitive. Handling precaution recommended.
- 4) The device is not guaranteed to function outside of its operating conditions.
- 5) Measured on JESD51-7, 4-layer PCB.

**ELECTRICAL CHARACTERISTICS** $V_{IN} = 5.5V$, $T_J = -20^{\circ}C$ to $+125^{\circ}C$, unless otherwise noted.

Parameter	Symbol	Condition	Min	Typ	Max	Units
Power-On Reset						
Output voltage	V_{OUT}	$5.5V < V_{IN} < V_{OVP}$, $I_{OUT} = 1mA$	4.6	5	5.4	V
V_{IN} rising threshold	V_{POR}		2.4		2.8	V
POR hysteresis				150		mV
Supply current	I_{IN}	\overline{CE} is low, $V_{IN} = 5V$, no load			600	μA
		\overline{CE} is high, $V_{IN} = 5.5V$			100	μA
Input power-on blanking time	$T_{REC(Vout)}$	V_{IN} rising to V_{OUT} rising		8		ms
Protection						
Input over-voltage protection (OVP)	V_{OVP}	MP2678EG	9.9	10.4	10.8	V
Input OVP hysteresis				150		mV
Input OVP propagation delay ⁽⁶⁾				1		μs
Input OVP recovery time	$T_{REC(OVP)}$			8		ms
Over-current protection (OCP)	I_{OCP}	$3V < V_{IN} < V_{OVP}$	1.2	1.5	1.7	A
OCP blanking time	BT_{OCP}			170		μs
OCP recovery time	$T_{REC(OCP)}$			50		ms
Battery OVP threshold	V_{BOVP}		4.23	4.35	4.5	V
Battery OVP hysteresis				150		mV
Battery OVP blanking time	BT_{BOVP}			176		μs
VB Leakage Current		$T_J = 25^{\circ}C$			100	nA
Over-Temperature Protection (OTP) Rising Threshold				140	150	$^{\circ}C$
OTP Falling Threshold				20		$^{\circ}C$
Logic						
\overline{FLT} output logic low		5mA sink current		0.2		V
\overline{FLT} output logic high leakage current					10	μA
\overline{CE} logic low threshold	V_{IH}				0.4	V
\overline{CE} logic high threshold	V_{IL}		1.5			V
Input to Output Characteristics						
Dropout voltage	V_{DO}	$V_{IN} = V_{OUT(NOM)} - 0.1V$, $I_{OUT} = 1A$			330	mV
Q1 off-state leakage current	I_{OFF}	\overline{CE} is high, $V_{IN} = 5.5V$			10	μA

Note:

6) Guarantee by design.

TYPICAL PERFORMANCE CHARACTERISTICS

$V_{IN} = 6V$, $V_{BATT} = GND$, $R_{VB} = 10k\Omega$, $R_{FLT} = 6.04k\Omega$, $C_{IN} = 1\mu F$, $C_{OUT} = 1\mu F$, $T_A = 25^\circ C$, unless otherwise noted.

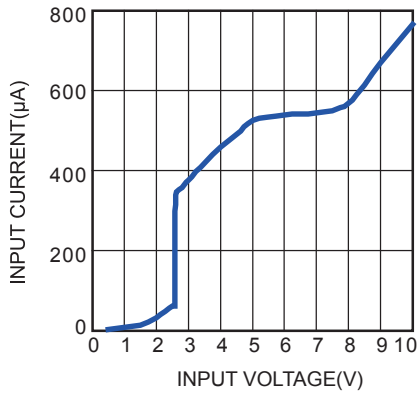
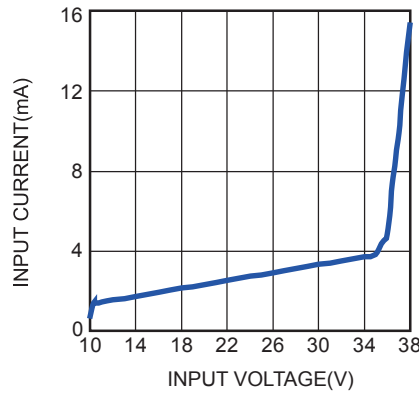
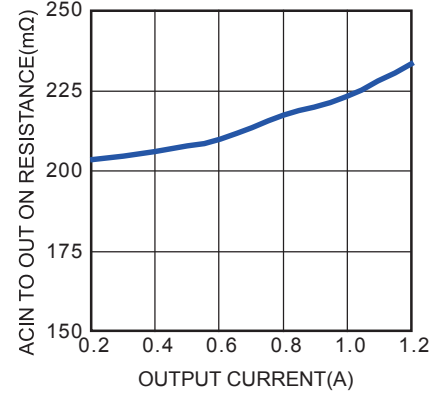
Supply Current vs. V_{IN}

Breakdown Voltage

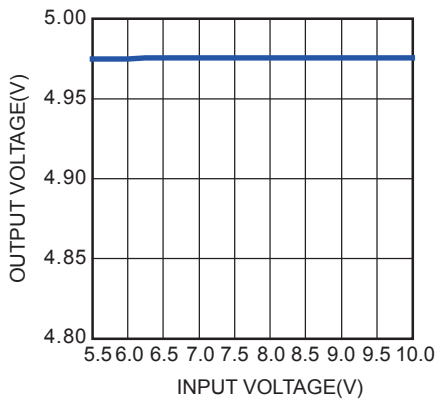
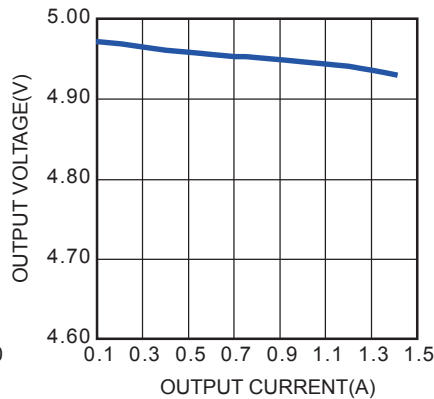
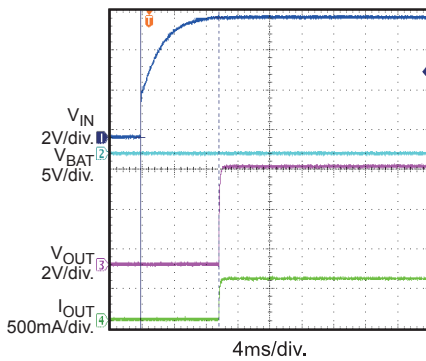
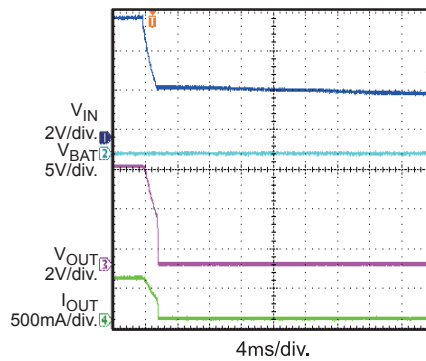
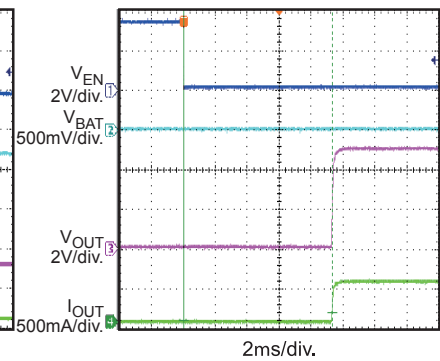
ACIN to OUT On Resistance vs. I_{OUT}

Line Regulation

No Load

Load Regulation

Power On
 $R_{OUT}=10\Omega$

Power Off
 $R_{OUT}=10\Omega$

En On
 $R_{OUT}=10\Omega$

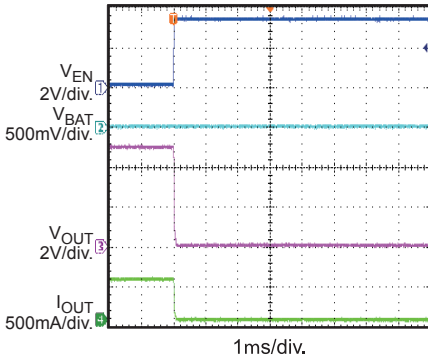
TYPICAL PERFORMANCE CHARACTERISTICS (continued)

$V_{IN} = 6V$, $V_{BATT} = GND$, $R_{VB} = 10k\Omega$, $R_{FLT} = 6.04k\Omega$, $C_{IN} = 1\mu F$, $C_{OUT} = 1\mu F$, $T_A = 25^\circ C$, unless otherwise noted.

En Off
 $R_{OUT}=10\Omega$



Input OVP Start Up
 V_{IN} jumps from 0V to 30V
 $R_{OUT}=10\Omega$

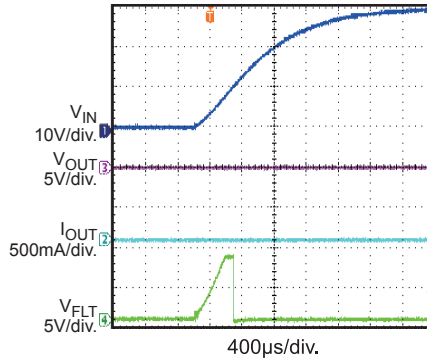

Input OVP
 V_{IN} steps from 6V to 12V
 $R_{OUT}=10\Omega$

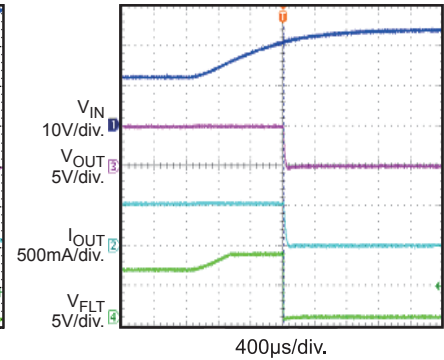

Input OVP Recovery
 V_{IN} drops from 12V to 6V
 $R_{OUT}=10\Omega$

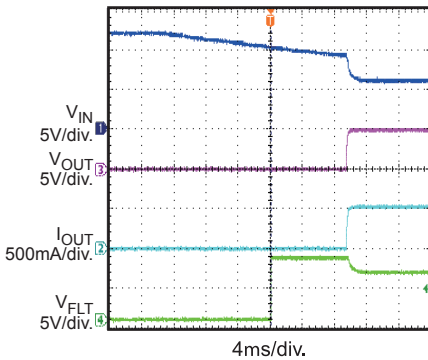

Battery OVP
 V_{BATT} switches between 4V and 5V
 $R_{OUT}=10\Omega$

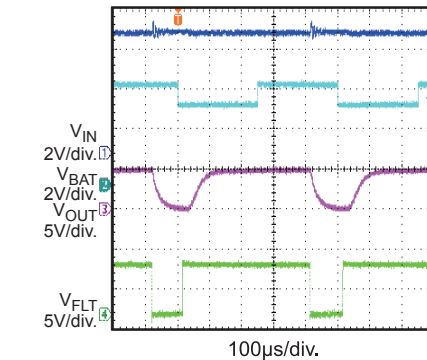

OCP
Increase I_{OUT} to OCP point
after input start up

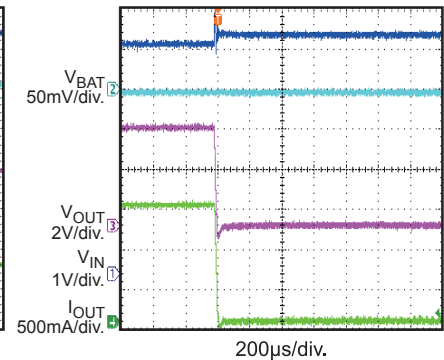

SCP
Short the OUT to GND

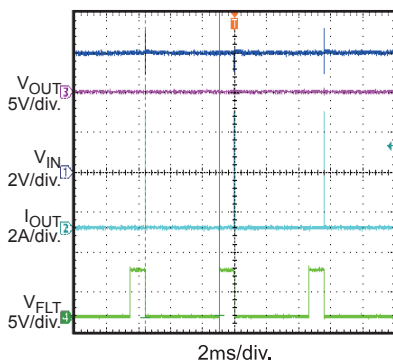

SCP Recovery
Remove the short wire

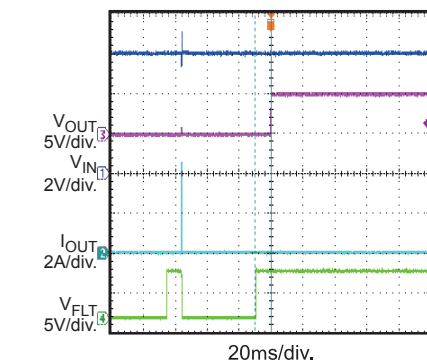

OTP
Increase T_A till the part shuts down
 $R_{OUT}=10\Omega$

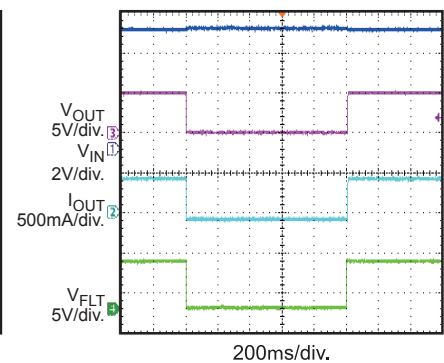

FUNCTIONAL BLOCK DIAGRAM

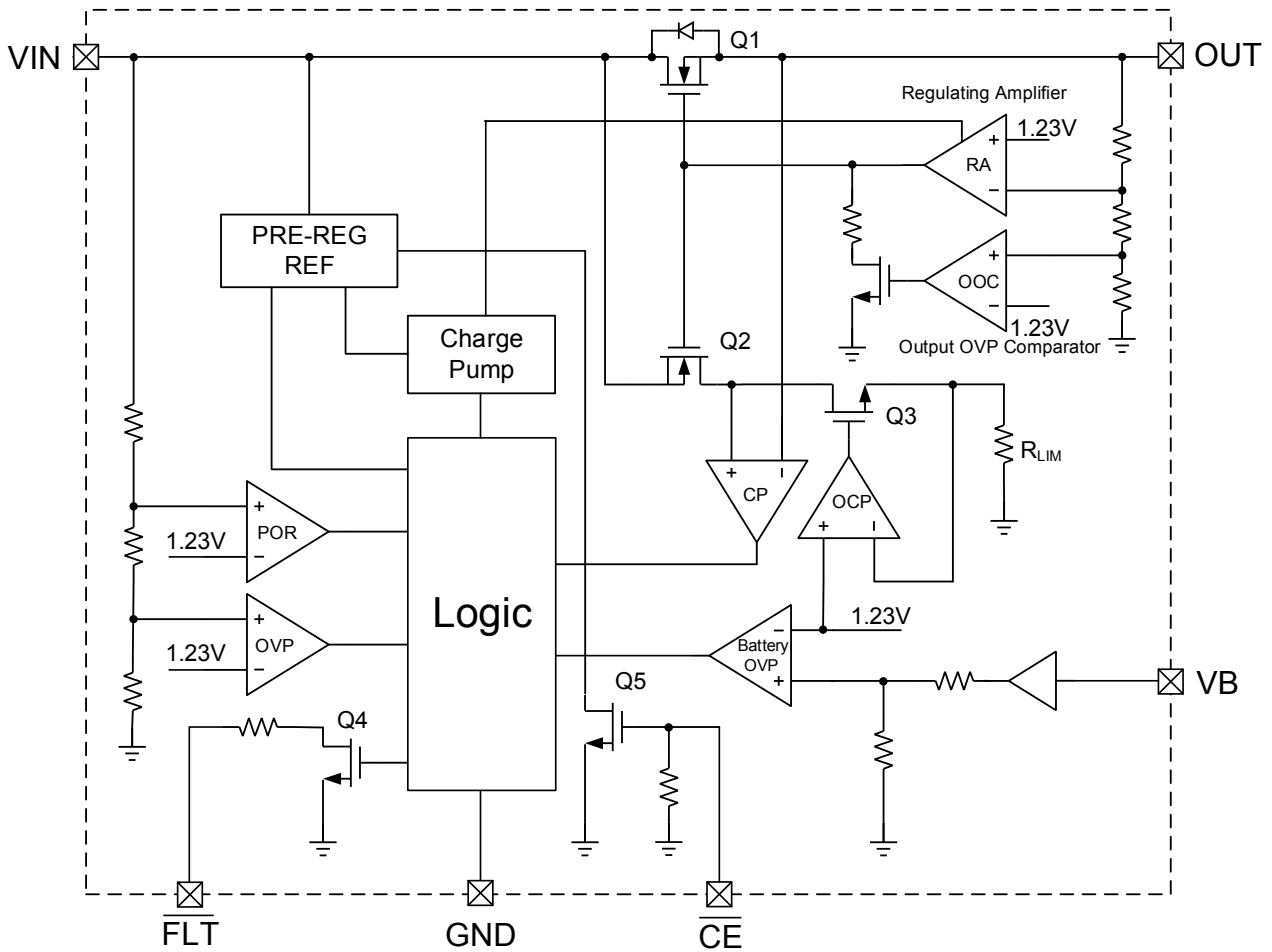

Figure 1: Functional Block Diagram

OPERATION

The MP2678 is a high-performance, single-cell Li-ion and Li-polymer battery charger protection IC. Its integrated high-voltage input protection allows the IC to tolerate input surges up to 30V.

The device operates similar to a linear regulator, and maintains a regulated 5V output at input voltages up to the over-voltage protection (OVP) threshold (10.4V).

Full protection features include input OVP, MPS proprietary battery OVP, and over-current protection (OCP). If a fault event occurs, the internal N-channel MOSFET turns off to disconnect the charging circuit from the input. Fault indication is also provided to indicate when a fault event occurs.

Thermal monitoring and thermal shutdown are provided to guarantee safe operation. The MP2678 monitors the internal temperature. If the die temperature exceeds the thermal shutdown threshold (typically 140°C), then the N-channel MOSFET bridging the input and output turns off.

For guaranteed safe operation, the MP2678 monitors its internal temperature and turns off the N-MOSFET bridging VIN and OUT when the die temperature exceeds 140°C.

Power-On Reset

The MP2678 has a power-on reset (POR) threshold of 2.8V, with a built-in hysteresis of 150mV. If the input voltage (V_{IN}) drops below the POR threshold, then the internal N-channel MOSFET turns off. The IC resets itself and is followed by an 8ms delay. If V_{IN} and battery voltage (V_{BATT}) are at safe levels, then the N-channel MOSFET turns on again. During a hot insertion of the power supply, the 8ms delay allows any transient to settle before the IC resumes normal operation.

Input Over-Voltage Protection (OVP)

The IC's internal comparator monitors V_{IN} continuously. If the input voltage exceeds the OVP threshold (V_{OVP}), then the internal N-channel MOSFET turns off within 1 μ s,

preventing the high V_{IN} from damaging the electronics in the handheld system. Input OVP has a typical threshold of 10.4V. Once the over-voltage (OV) condition is removed, then the N-channel MOSFET turns on again. Due to the 8ms delay, the output is not enabled during a fault condition where V_{IN} quickly exceeds V_{OVP} .

Battery Over-Voltage Protection (OVP)

The battery OVP threshold (V_{BOVP}) is set internally to 4.35V. The threshold has an integrated 150mV hysteresis. The VB pin monitors V_{BATT} . If V_{BATT} exceeds V_{BOVP} , then VB issues an OV signal to turn off the N-channel MOSFET. The internal comparator has a built-in blanking time (176 μ s) to prevent any transient voltage from triggering an OV fault. If the OV condition is still present after the blanking time, then the power MOSFET turns off.

Over-Current Protection (OCP)

The internal N-channel MOSFET's current is limited. This prevents charging the battery with an excessive current. The OCP threshold is set to 1.5A by default. If an over-current (OC) condition occurs, the \overline{FLT} pin is pulled low and the timer ($t_{REC(OCP)}$) begins. Once $t_{REC(OCP)}$ expires, \overline{FLT} is pulled high, and the part restarts again after an 8ms delay.

Thermal Shutdown

The MP2678 monitors its die temperature to prevent any thermal failure. When the internal temperature reaches 140°C, the internal N-channel MOSFET is turned off and the \overline{FLT} pin is pulled low. The IC does not resume operation until the internal temperature drops below 120°C.

Enable (EN) Function

The MP2678 has an active-low \overline{CE} pin that enables and disables the IC. Pull \overline{CE} high to turn the internal N-channel MOSFET off; pull \overline{CE} low to turn it on and begin the start-up sequence. \overline{CE} has an internal pull-down resistor that can remain unconnected.

Fault Indication

The $\overline{\text{FLT}}$ pin is an open-drain output that indicates a low signal when any of the following fault events occur:

1. Output short-circuit condition
2. Input OV condition
3. Battery OV condition
4. Thermal shutdown

If $\overline{\text{CE}}$ goes high, then $\overline{\text{FLT}}$ is pulled high.

APPLICATION INFORMATION

For safe and effective charging, certain requirements have to be satisfied while charging Li-Ion batteries, such as a high, precise power source (4.2V \pm 50mV). For charging, the accuracy should be above 1%. For highly used capacity, V_{BATT} should not be charged to above 4.2V; otherwise, the performance and battery life can suffer from over-charging.

Linear battery chargers require pre-charge for depleted batteries, charge voltage, charge current, temperature monitoring, and thermal shutdown. The typical output of an MPS linear charger has an I-V curve, which provides OCP, battery OVP, input OVP, and over-temperature protection (OTP). The function of the MP2678 is to add a redundant protection layer such that, under any fault condition, the charging system output does not exceed the I-V limits required by the battery.

Additionally, the MP2678 provides full protection features for chargers that do not have complete protection (particularly for those without input surge voltage sustainability). The MP2678 guarantees the charge system's safety with its full protection features, including OVP, battery OVP, OCP, and OTP.

An internal N-channel MOSFET regulates the output voltage (V_{OUT}) at 5V while V_{IN} reaches V_{OVP} .

The MP2678 requires a minimal number of standard, external components, in addition to the linear charger circuit as shown in the Typical Application Circuit on page 1.

Selecting the Input Capacitor (C_{IN}) and Output Capacitor (C_{OUT})

The input capacitor (C_{IN}) is used for decoupling. A higher C_{IN} capacitance reduces the voltage drop and the overshoot during transients. The AC adapter is inserted live (i.e. hot insertion). The sudden step down of the current may cause V_{IN} to overshoot. During an input OV condition, the N-channel MOSFET turns off in less than 1 μ s, which can to significant overshooting. A higher C_{IN} capacitance reduces this type of overshoot. However, overshoot caused by a hot insertion is not entirely dependent on the decoupling capacitance.

It is recommended that C_{IN} be a dielectric ceramic capacitor between 1 μ F to 4.7 μ F.

The MP2678 output and charging circuit input typically share one decoupling output capacitor (C_{OUT}). The selection of C_{OUT} is predominately determined by the charging circuit requirement. When using the MP2602 family chargers, it is recommended that C_{OUT} be a 1 μ F to 4.7 μ F ceramic capacitor.

Selecting the VB Resistor (R_{VB})

R_{VB} limits the current from the VB pin to the battery terminal in case the MP2678 fails. It is recommended that the R_{VB} resistance be between 200k Ω to 1M Ω . For example, during a failure operation, the worst-case scenario for the current flowing from VB to the charger output can be calculated with Equation (1):

$$(V_{VB} - V_{BATT}) / R_{VB} = 130\mu A \quad (1)$$

Where R_{VB} is 200k Ω , the VB pin voltage (V_{VB}) is 30V, and V_{BATT} is 4.2V.

Such small currents can be absorbed easily by the bias current of other components. A larger-value resistor reduces the worst-case scenario current. However, a larger-value resistor can increase the error of the battery's OVP threshold (4.35V).

The typical VB leakage current is 20nA. the error of V_{BOVP} can be calculated with Equation (2):

$$4.35V + 20nA \times R_{VB} \quad (2)$$

With a 200k Ω resistor, the worst-case scenario for the additional error is 4mV. With a 1M Ω resistor, the worst-case additional error is 20mV.

Selecting the \overline{FLT} Resistor (R_{FLT})

If a fault events occurs, the \overline{FLT} pin is pulled low and the pull-up resistor (R_{FLT}) limits the sink current (I_{SINK}). The maximum I_{SINK} should not exceed 5mA during the worst-case scenario, which means that V_{IN} should be 30V. Then the R_{FLT} can be calculated with Equation (3):

$$R_{FLT} > 30V / 5mA = 6k\Omega \quad (3)$$

It is recommended that R_{FLT} be between 6k Ω to 200k Ω . When using an LED driver to indicate the status, select a smaller-value resistor (e.g. 6.04k Ω) to drive the LED.

PACKAGE INFORMATION

QFN-8 (2mmx2mm)

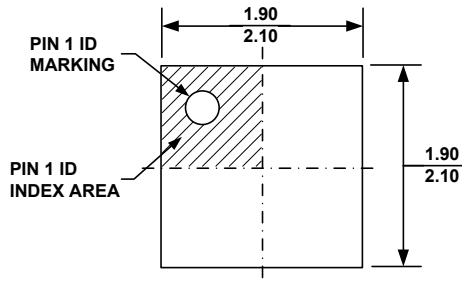

TOP VIEW

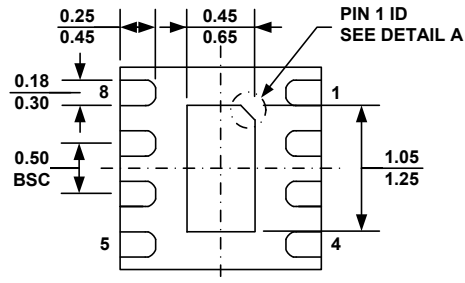

BOTTOM VIEW

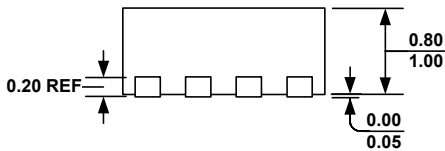

SIDE VIEW

PIN 1 ID OPTION A
0.30x45° TYP.

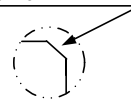

PIN 1 ID OPTION B
R0.20 TYP.

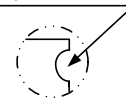

DETAIL A

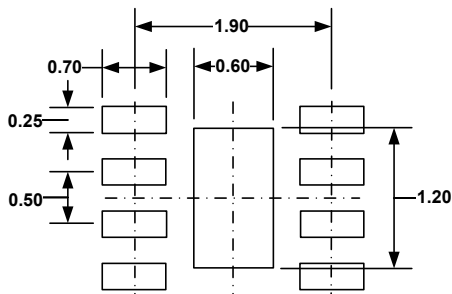

RECOMMENDED LAND PATTERN

NOTE:

- 1) ALL DIMENSIONS ARE IN MILLIMETERS.
- 2) EXPOSED PADDLE SIZE DOES NOT INCLUDE MOLD FLASH.
- 3) LEAD COPLANARITY SHALL BE 0.10 MILLIMETER MAX.
- 4) DRAWING CONFORMS TO JEDEC MO-229, VARIATION VCCD-3.
- 5) DRAWING IS NOT TO SCALE.





REVISION HISTORY

Revision #	Revision Date	Description	Pages Updated
1.0	1/6/2011	Initial Release	-
1.1	7/19/2021	Updated the Description section; updated the footnote below the Applications section	1
		Updated the part number from “MP2678EG-104-LF-Z” to “MP2678EG-LF-Z”; removed “-XXX” suffix option; added the package information to the Package Reference section	2
		Added equation numbers	10
		Grammatical, formatting, and clerical updates; updated headers and footers; updated pagination	All

Notice: The information in this document is subject to change without notice. Please contact MPS for current specifications. Users should warrant and guarantee that third-party Intellectual Property rights are not infringed upon when integrating MPS products into any application. MPS will not assume any legal responsibility for any said applications.

Looking for pricing, stock, or lifecycle information?

Click below to explore more details on WIN SOURCE:

-  [View SST3I-C on WIN SOURCE](#)
-  [Panduit Corp Information](#)

Optimize Your Supply Chain with WIN SOURCE Solutions

-  Global Sourcing Solution
-  Obsolete Management
-  Cost Control Management
-  Shortage Management
-  Alternative Solution
-  Excess Inventory Management