



**THE DATASHEET OF
SPA391M0ER**



Solid Polymer Aluminum SMT Capacitors



Solid Polymer Aluminum capacitors combine the high capacitance capability of an electrolytic component with the high frequency performance of film capacitors. When the need for low impedance at high frequency is critical for your design, one ESRD chip is capable of replacing several liquid electrolyte aluminum or tantalum capacitors connected in parallel.

Highlights

- Ultra-Low ESR - 5 mΩ to 9 mΩ @ 100 kHz
- High Ripple Current - up to 4.0 Arms at 100 kHz
- Long Life - No dry out failure related mechanism
- Stable Impedance and ESR vs. Temperature
- Great for bulk storage and ripple filtering
- Ignition free

Specifications

Capacitance Range	2.2 μF to 470 μF
Capacitance Tolerance	±20% at 120 Hz and 20 °C
DF	10% max at 120 Hz and 20 °C ESRD (1.8 mm height): 6% max.
Surge Test	Performed at 20°C with a 1000 ohm series resistor. Apply 1.25 x the rated voltage for 1000 cycles of 30 sec. on and 5 min. and 30 sec. off. After surge voltage testing, no abnormal change in appearance shall occur because of the test, and the capacitance shall be within ±10% of the initial measured value, and the DCL and DF shall meet the initial specifications.
Operating Temperature Range	-55 °C to +105 °C at 100% of the rated voltage (ESRH: -55°C to +125°C at 75% of the rated voltage)
DC Leakage Current (DCL)	After a two minute application of the rated working voltage at +20 °C: 2 V - 4 V: $I \leq 0.06 CV$, 6.3 V - 16 V: $I \leq 0.04 CV$ or 3μA (whichever is greater) SPSX and SPCX: $I \leq 0.1 CV$
Moisture Resistance	Store capacitor for 500 hours at +60 °C and 90% to 95% RH without load. After the test, the capacitors will meet the following limits: Δ C = +70%/-20% of the initial measured value (2.0 Vdc, 2.5 Vdc), +60%/-20% of the initial measured value (4.0 Vdc), +50%/-20% of the initial measured value (6.3 Vdc), +40%/-20% of the initial measured value (all other voltages) DF ≤ two times the initial specified value DCL ≤ the initial specified value
Life Test	Apply rated DC working voltage at 105 °C for 1000 hours, and then stabilize them to +20 °C. After the test, the capacitors will meet the following limits: Δ C = ±10% of the initial measured value DF ≤ the initial specified value DCL ≤ the initial specified value
Shelf Life Test	Shelf life is typically 5 to 10 years. Accelerated test: 500 hours at 105 °C, and then stabilize them to +20 °C. After the test, the capacitors will meet the following limits: Δ C = ±10% of the initial measured value DF ≤ the initial specified value DCL ≤ the initial specified value
Vibration	Capacitors are soldered to a board and then subjected to a vibration of 1.5 mm amplitude that is varied from 10 Hz to 2000 Hz to 10 Hz in 20 min. cycles. The test duration is 2 hours for each of the three right angle directions (total 6 hours). Capacitance is monitored during the last cycle of the test for stability. No abnormal change in appearance shall occur because of the test.

Solid Polymer Aluminum SMT Capacitors

Part Numbering System

ESRD	4R7	M			16	R
Type	Capacitance	Tolerance			Voltage	Packaging Code
	4R7 = 4.7 μ F	M = \pm 20%	02 = 2.0 Vdc	08 = 8.0 Vdc		R = Tape and Reel
	220 = 22 μ F		0E = 2.5 Vdc	12 = 12.5 Vdc		
	101 = 100 μ F		04 = 4.0 Vdc	16 = 16.0 Vdc		
			06 = 6.3 Vdc			

Dimensions

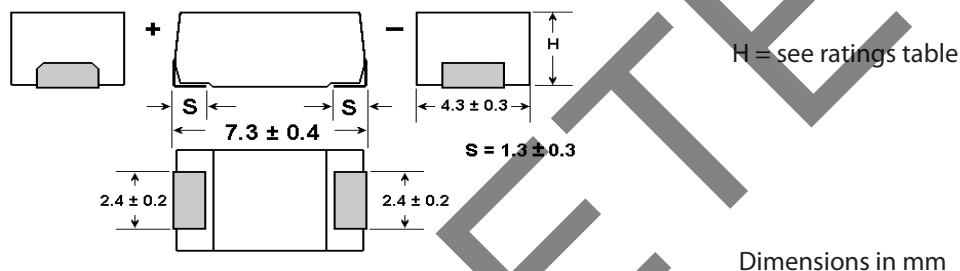

Ratings

Capacitance (μ F)	Catalog Part Number (Tape & Reel)	Rated Voltage WVDC	Maximum E.S.R. 100 kHz/20 °C (Ω)	Maximum Ripple Current 100 kHz/105 °C Arms	Case Height (mm)	Peak Soldering Temperature (°C)	Qty/ Reel
100	ESRD101M02R	2.0	0.018	2.5	1.8 \pm 0.1	240	3500
120	ESRD121M02XR	2.0	0.015	2.7	1.8 \pm 0.1	240	3500
120	SPA121M02R	2.0	0.009	3.0	1.8 \pm 0.1	240	3500
150	SPA151M02R	2.0	0.009	3.0	1.8 \pm 0.1	240	3500
180	ESRD181M02R	2.0	0.015	3.0	2.8 \pm 0.2	240	2000
180	ESRH181M02R	2.0	0.015	2.5	2.8 \pm 0.2	240	2000
180	SPA181M02R	2.0	0.009	3.0	1.9 \pm 0.2	240	3500
180	SPSX181M02R	2.0	0.009	3.0	1.9 \pm 0.2	260	3500
220	ESRD221M02R	2.0	0.015	3.0	2.8 \pm 0.2	240	2000
220	SPCX221M02R	2.0	0.015	2.7	1.9 \pm 0.2	260	3500
220	SPSX221M02R	2.0	0.009	3.0	1.9 \pm 0.2	260	3500
270	ESRD271M02XR	2.0	0.012	3.3	2.8 \pm 0.2	240	2000
270	ESRH271M02R	2.0	0.012	3.0	4.1 \pm 0.2	240	2000
270	ESRE271M02R	2.0	0.015	3.0	4.1 \pm 0.3	240	2000
270	SPSX271M02R	2.0	0.009	3.0	1.9 \pm 0.2	260	3500
330	ESRE331M02R	2.0	0.015	3.0	4.1 \pm 0.3	240	2000
330	SPCX331M02R	2.0	0.015	2.7	1.9 \pm 0.2	260	3500
330	SPSX331M02R	2.0	0.009	3.0	1.9 \pm 0.2	260	3500
390	ESRE391M02XR	2.0	0.010	3.5	4.1 \pm 0.3	240	2000
390	SPCX391M02R	2.0	0.015	2.7	1.9 \pm 0.2	260	3500
390	SPSX391M02R	2.0	0.009	3.0	1.9 \pm 0.2	260	3500
470	SPA471M02R	2.0	0.005	4.0	4.2 \pm 0.1	240	2000
470	SPCX471M02R	2.0	0.015	2.7	1.9 \pm 0.2	260	3500
470	SPSX471M02R	2.0	0.009	3.0	1.9 \pm 0.2	260	3500

Solid Polymer Aluminum SMT Capacitors

Capacitance (μ F)	Catalog Part Number (Tape & Reel)	Rated Voltage WVDC	Maximum	Maximum	Case Height (mm)	Peak	Qty/ Reel
			E.S.R. 100 kHz/20 °C (Ω)	Ripple Current 100 kHz/105 °C Arms		Soldering Temperature (°C)	
100	ESRD101M0EXR	2.5	0.015	2.7	1.8 ±0.1	240	3500
100	SPA101M0ER	2.5	0.009	3.0	1.8 ±0.1	240	3500
120	SPA121M0ER	2.5	0.009	3.0	1.8 ±0.1	240	3500
150	ESRD151M0ER	2.5	0.015	3.0	2.8 ±0.2	240	2000
150	ESRH151M0ER	2.5	0.015	2.5	2.8 ±0.2	240	2000
150	SPA151M0ER	2.5	0.009	3.0	1.9 ±0.2	240	3500
150	SPSX151M0ER	2.5	0.009	3.0	1.9 ±0.2	260	3500
180	ESRD181M0ER	2.5	0.015	3.0	2.8 ±0.2	240	2000
180	SPSX181M0ER	2.5	0.009	3.0	1.9 ±0.2	260	3500
220	ESRD221M0EXR	2.5	0.012	3.3	2.8 ±0.2	240	2000
220	ESRH221M0ER	2.5	0.012	3.0	4.1 ±0.2	240	2000
220	ESRE221M0ER	2.5	0.015	3.0	4.1 ±0.3	240	2000
220	SPCX221M0ER	2.5	0.015	2.7	1.9 ±0.2	260	3500
220	SPSX221M0ER	2.5	0.009	3.0	1.9 ±0.2	260	3500
270	ESRE271M0ER	2.5	0.015	3.0	4.1 ±0.3	240	2000
330	ESRE331M0EXR	2.5	0.01	3.5	4.1 ±0.3	240	2000
330	SPA331M0ER	2.5	0.005	4.0	4.2 ±0.1	240	2000
330	SPCX331M0ER	2.5	0.015	2.7	1.9 ±0.2	260	3500
330	SPSX331M0ER	2.5	0.009	3.0	1.9 ±0.2	260	3500
390	SPA391M0ER	2.5	0.005	4.0	4.2 ±0.1	240	2000
390	SPCX391M0ER	2.5	0.015	2.7	1.9 ±0.2	260	3500
390	SPSX391M0ER	2.5	0.009	3.0	1.9 ±0.2	260	3500
56	ESRD560M04R	4.0	0.018	2.5	1.8 ±0.1	240	3500
82	ESRD820M04XR	4.0	0.015	2.7	1.8 ±0.1	240	3500
82	SPA820M04R	4.0	0.009	3.0	1.8 ±0.1	240	3500
82	SPSX820M04R	4.0	0.009	3.0	1.9 ±0.2	260	3500
100	SPA101M04R	4.0	0.009	3.0	1.9 ±0.2	240	3500
100	SPSX101M04R	4.0	0.009	3.0	1.9 ±0.2	260	3500
120	ESRD121M04R	4.0	0.015	3.0	2.8 ±0.2	240	2000
120	ESRH121M04R	4.0	0.015	2.5	2.8 ±0.2	240	2000
150	ESRD151M04XR	4.0	0.012	3.3	2.8 ±0.2	240	2000
150	SPCX151M04R	4.0	0.015	2.7	1.9 ±0.2	260	3500
150	SPSX151M04R	4.0	0.009	3.0	1.9 ±0.2	260	3500
180	ESRH181M04R	4.0	0.012	3.0	4.1 ±0.2	240	2000
180	ESRE181M04R	4.0	0.015	3.0	4.1 ±0.3	240	2000
180	SPCX181M04R	4.0	0.015	2.7	1.9 ±0.2	260	3500
180	SPSX181M04R	4.0	0.009	3.0	1.9 ±0.2	260	3500
220	ESRE221M04XR	4.0	0.015	3.5	4.1 ±0.3	240	2000
220	SPA221M04R	4.0	0.005	4.0	4.2 ±0.1	240	2000
220	SPCX221M04R	4.0	0.015	2.7	1.9 ±0.2	260	3500
220	SPSX221M04R	4.0	0.009	3.0	1.9 ±0.2	260	3500
10	ESRD100M06R	6.3	0.055	1.4	1.8 ±0.1	240	3500

Solid Polymer Aluminum SMT Capacitors

Capacitance (μ F)	Catalog Part Number (Tape & Reel)	Rated Voltage WVDC	Maximum	Maximum	Case Height (mm)	Peak	Qty/ Reel
			E.S.R. 100 kHz/20 °C (Ω)	Ripple Current 100 kHz/105 °C Arms		Soldering Temperature (°C)	
22	ESRD220M06R	6.3	0.04	1.6	1.8 \pm 0.1	240	3500
33	ESRD330M06R	6.3	0.028	2.0	1.8 \pm 0.1	240	3500
47	ESRD470M06R	6.3	0.018	2.5	1.8 \pm 0.1	240	3500
56	SPA560M06R	6.3	0.009	3.0	1.8 \pm 0.1	240	3500
68	ESRD680M06XR	6.3	0.015	2.7	1.8 \pm 0.1	240	3500
68	SPA680M06R	6.3	0.009	3.0	1.9 \pm 0.2	240	3500
100	ESRD101M06R	6.3	0.015	3.0	2.8 \pm 0.2	240	2000
100	ESRH101M06R	6.3	0.015	2.5	2.8 \pm 0.2	240	2000
100	SPCX101M06R	6.3	0.015	2.7	1.9 \pm 0.2	260	3500
120	ESRD121M06XR	6.3	0.012	3.3	2.8 \pm 0.2	240	2000
120	SPCX121M06R	6.3	0.015	2.7	1.9 \pm 0.2	260	3500
150	ESRH151M06R	6.3	0.012	3.0	4.1 \pm 0.2	240	2000
150	ESRE151M06R	6.3	0.015	3.0	4.1 \pm 0.3	240	2000
150	SPCX151M06R	6.3	0.015	2.7	1.9 \pm 0.2	260	3500
150	SPSX151M06R	6.3	0.009	3.0	1.9 \pm 0.2	260	3500
180	ESRE181M06XR	6.3	0.015	3.5	4.1 \pm 0.3	240	2000
180	SPA181M06R	6.3	0.005	4.0	4.2 \pm 0.1	240	2000
8.2	ESRD8R2M08R	8.0	0.055	1.4	1.8 \pm 0.1	240	3500
15	ESRD150M08R	8.0	0.04	1.6	1.8 \pm 0.1	240	3500
22	ESRD220M08R	8.0	0.028	2.0	1.8 \pm 0.1	240	3500
33	ESRD330M08R	8.0	0.018	2.5	1.8 \pm 0.1	240	3500
68	ESRD680M08R	8.0	0.015	3.0	2.8 \pm 0.2	240	2000
68	ESRH680M08R	8.0	0.015	2.5	2.8 \pm 0.2	240	2000
100	ESRH101M08R	8.0	0.012	3.0	4.1 \pm 0.2	240	2000
100	ESRE101M08R	8.0	0.015	3.0	4.1 \pm 0.3	240	2000
4.7	ESRD4R7M12R	12.5	0.08	1.0	1.8 \pm 0.1	240	3500
10	ESRD100M12R	12.5	0.06	1.0	1.8 \pm 0.1	240	3500
15	ESRD150M12R	12.5	0.05	1.3	1.8 \pm 0.1	240	3500
22	ESRD220M12R	12.5	0.03	1.6	1.8 \pm 0.1	240	3500
2.2	ESRD2R2M16R	16.0	0.11	1.0	1.8 \pm 0.1	240	3500
4.7	ESRD4R7M16R	16.0	0.08	1.0	1.8 \pm 0.1	240	3500
6.8	ESRD6R8M16R	16.0	0.07	1.0	1.8 \pm 0.1	240	3500
8.2	ESRD8R2M16R	16.0	0.045	1.3	1.8 \pm 0.1	240	3500

Solid Polymer Aluminum SMT Capacitors

Tape Specifications

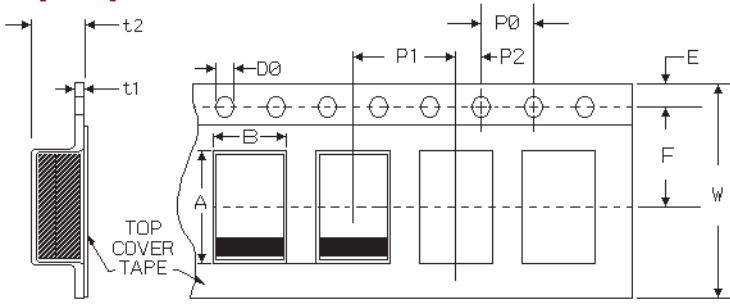

Solid Polymer Aluminum Type	ESRD	ESRE	ESRH	SPA
$t_2 = H + 0.3 \text{ mm} \pm 0.2 \text{ mm}$				

W	E	F	D ⁰	P ₀	P ₁	P ₂	A	B	t ₁
±0.3			+0.1/-0.0		±0.2		±0.2	±0.2	
12.0	1.8	5.5	1.5	4.0	8.0	2.0	7.7	4.6	0.4

Tol.: ±0.1 mm unless otherwise specified

Reel Specifications

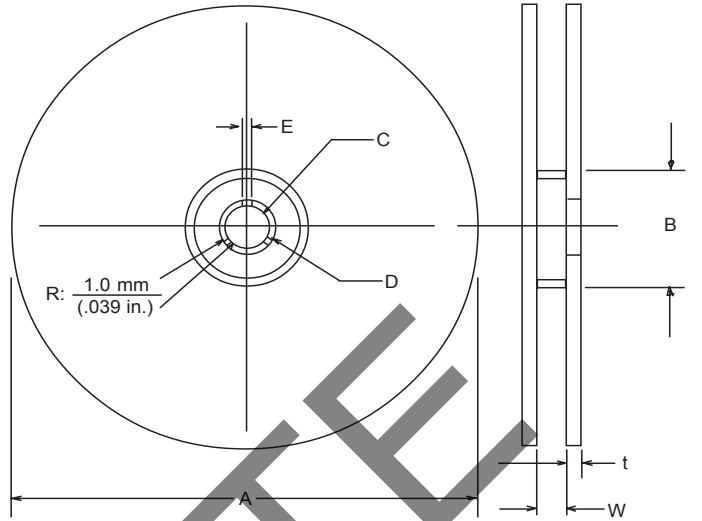

A	B	C	D	E	W	t
±0.2	Min.	±0.5	±0.8	±0.5	±1.0	
333.0	50.0	13.0	21.0	2.0	14.0	3.0

Typical Temperature Characteristics

Capacitance Change at 120 Hz

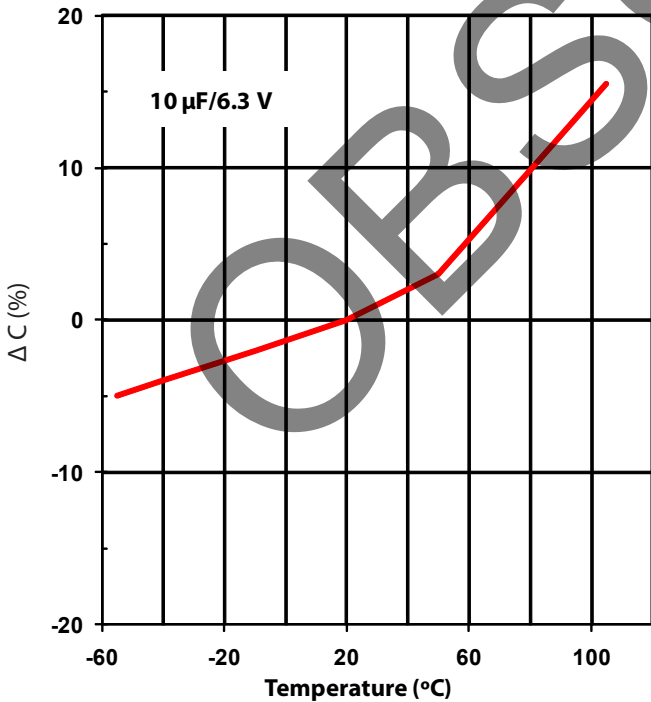

Dissipation Factor at 120 Hz

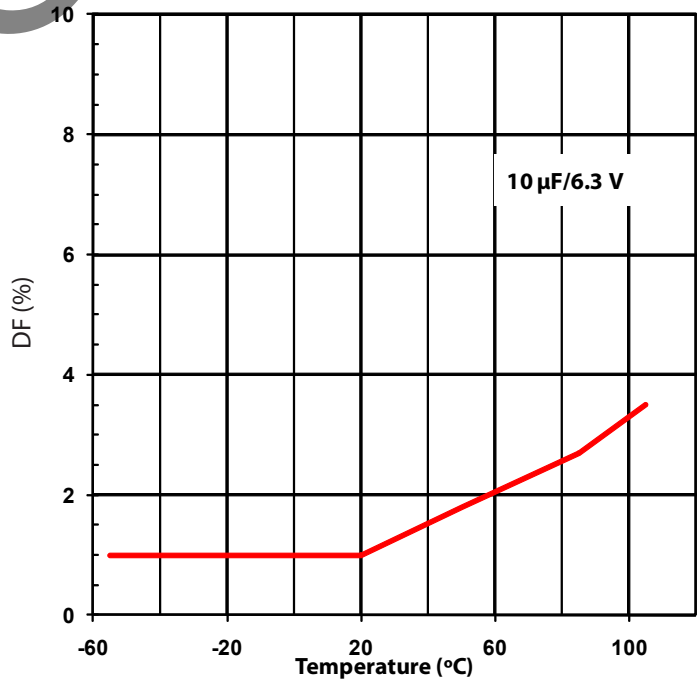

Solid Polymer Aluminum SMT Capacitors

Typical Impedance and Equivalent Series Resistance

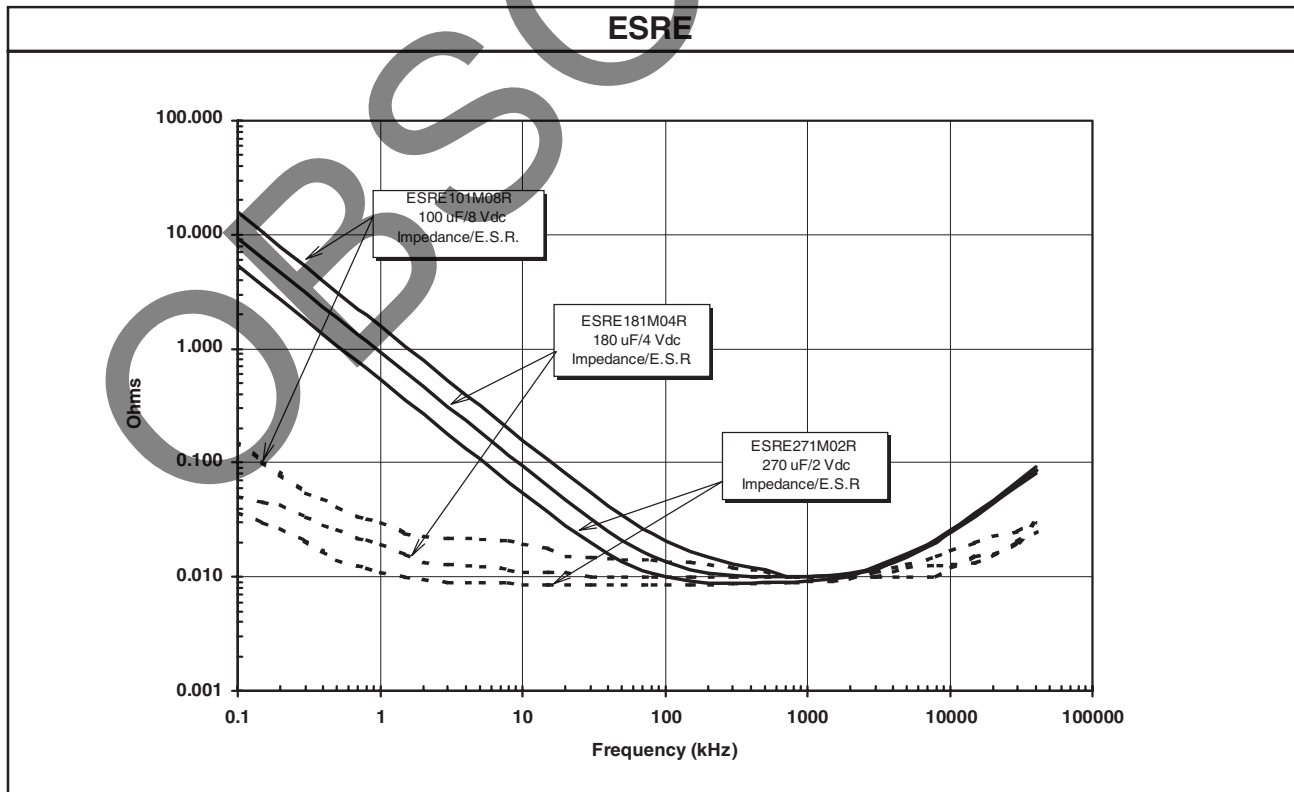
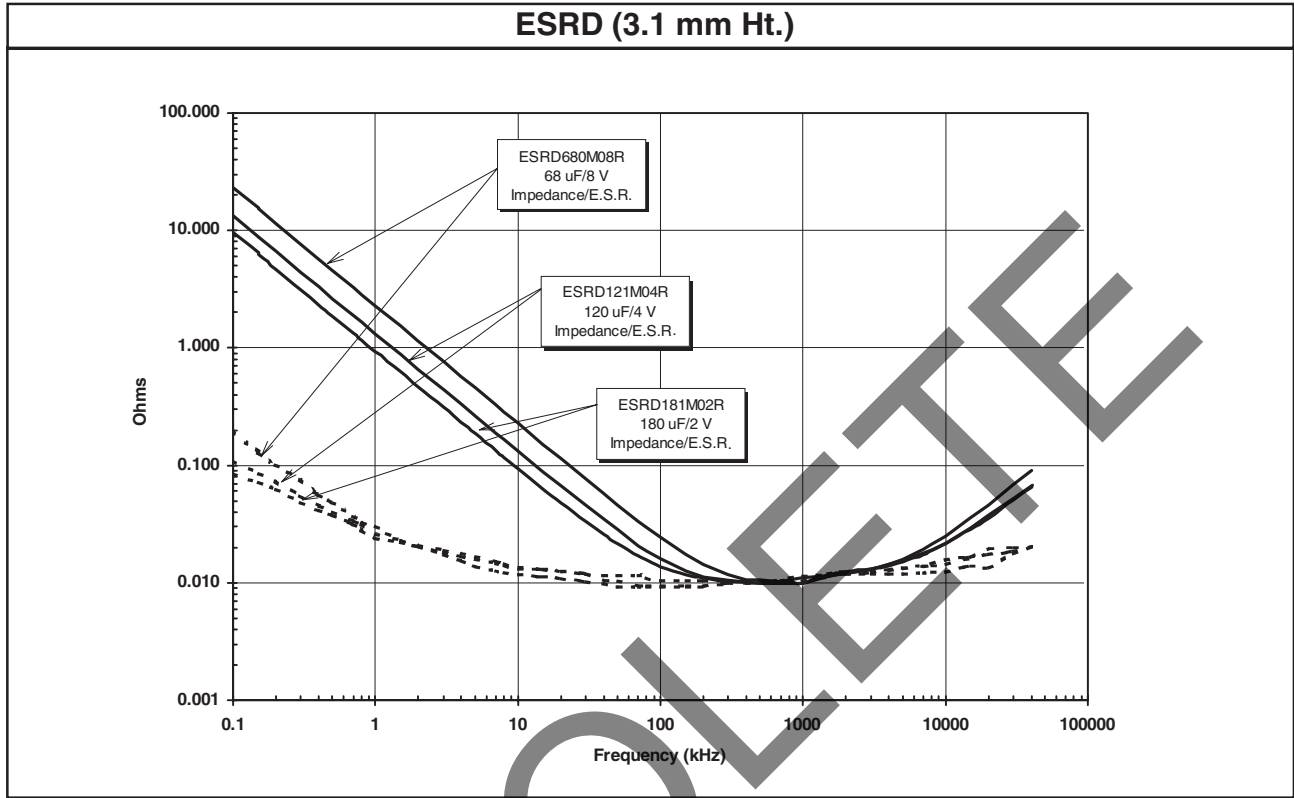

Solid Polymer Aluminum SMT Capacitors

Typical Impedance and Equivalent Series Resistance

ESRD - 6.3 Vdc

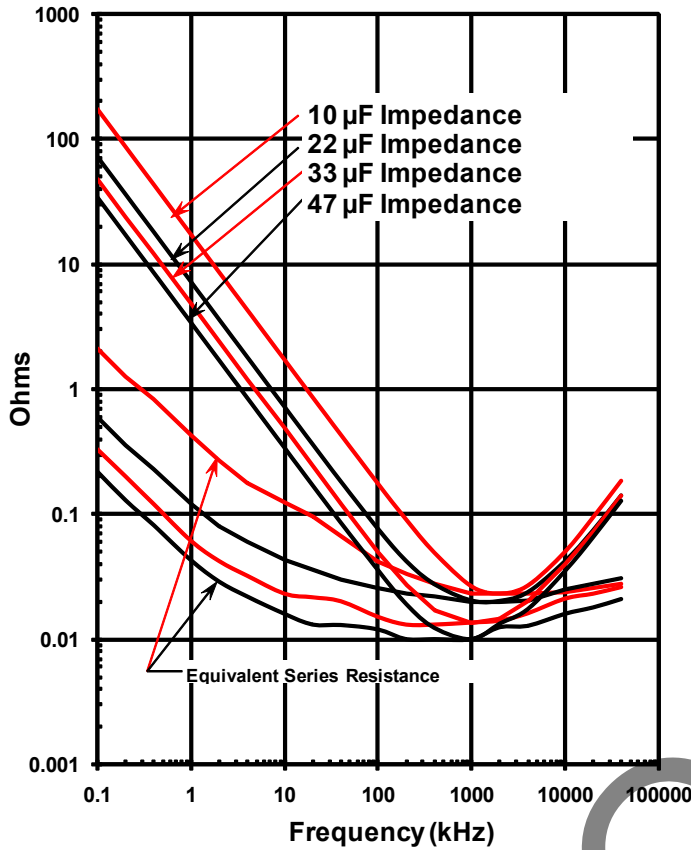

ESRD - 8.0 Vdc

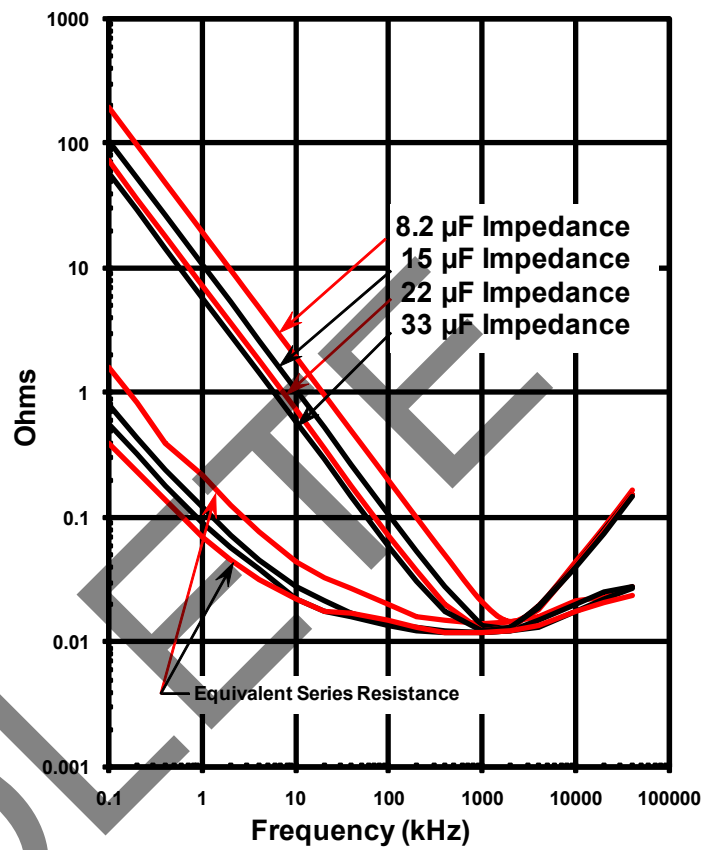

ESRD - 12.5 Vdc

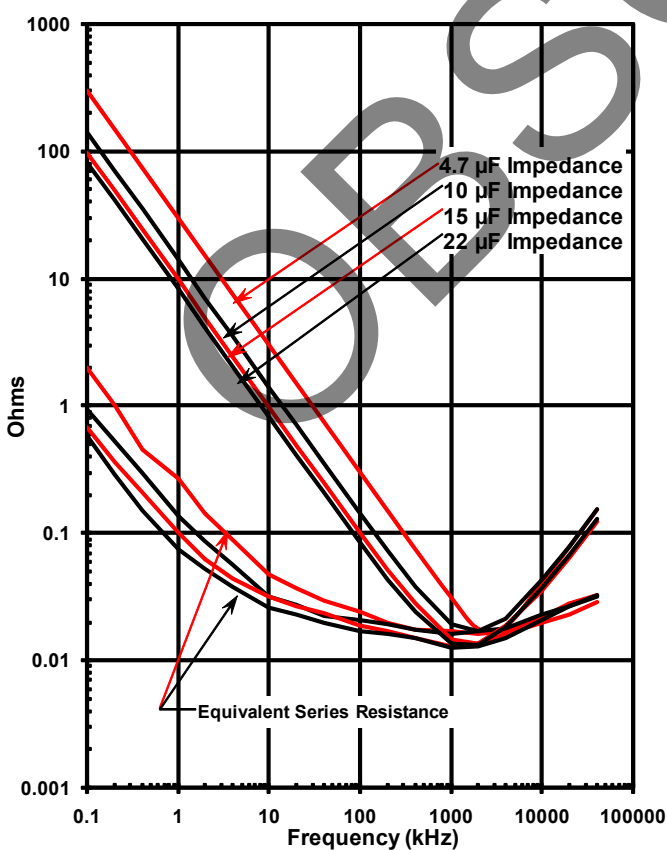

ESRD - 16.0 Vdc

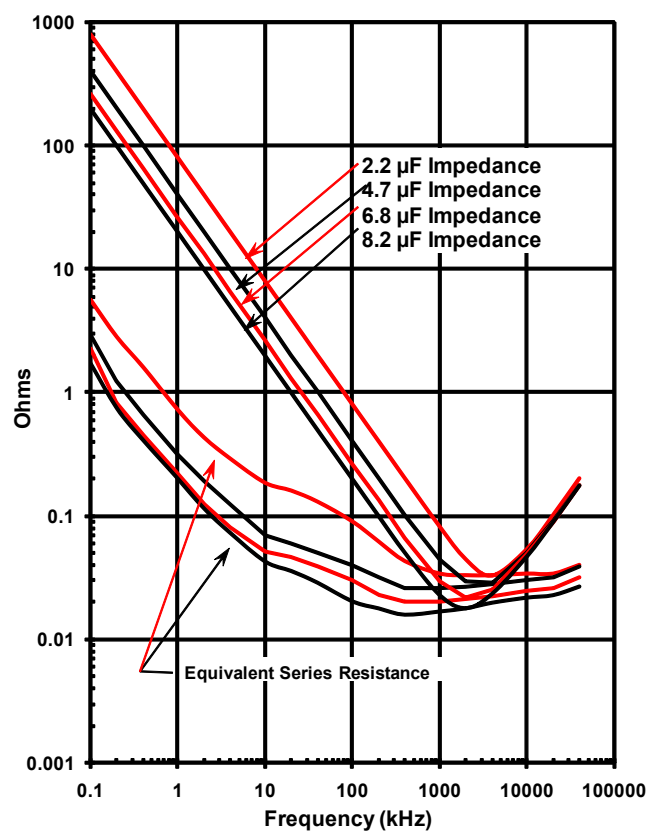

Solid Polymer Aluminum SMT Capacitors

Typical Temperature Characteristics

Impedance at 100 kHz

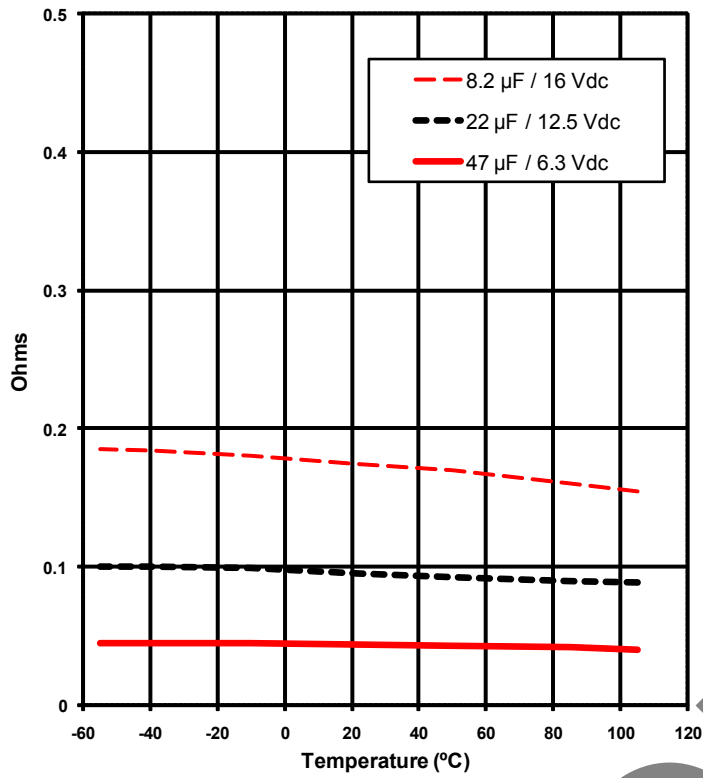

ESR at 100 kHz

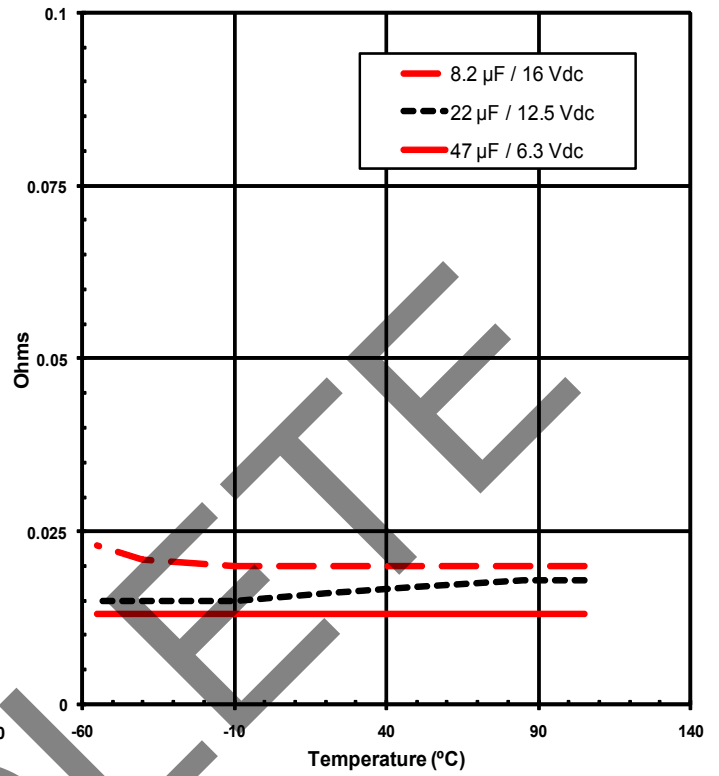

Impedance at 400 kHz

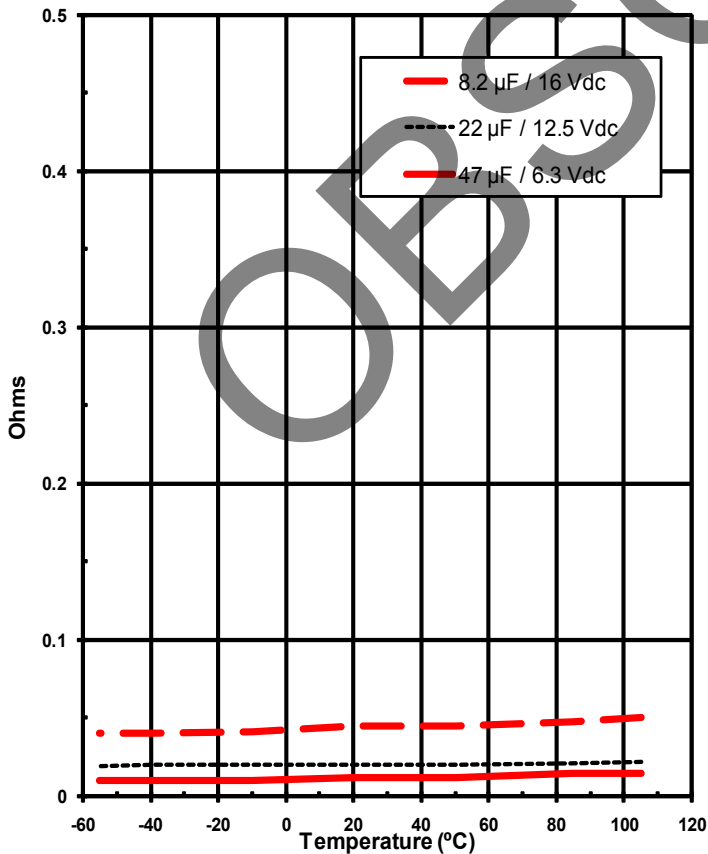

ESR at 400 kHz

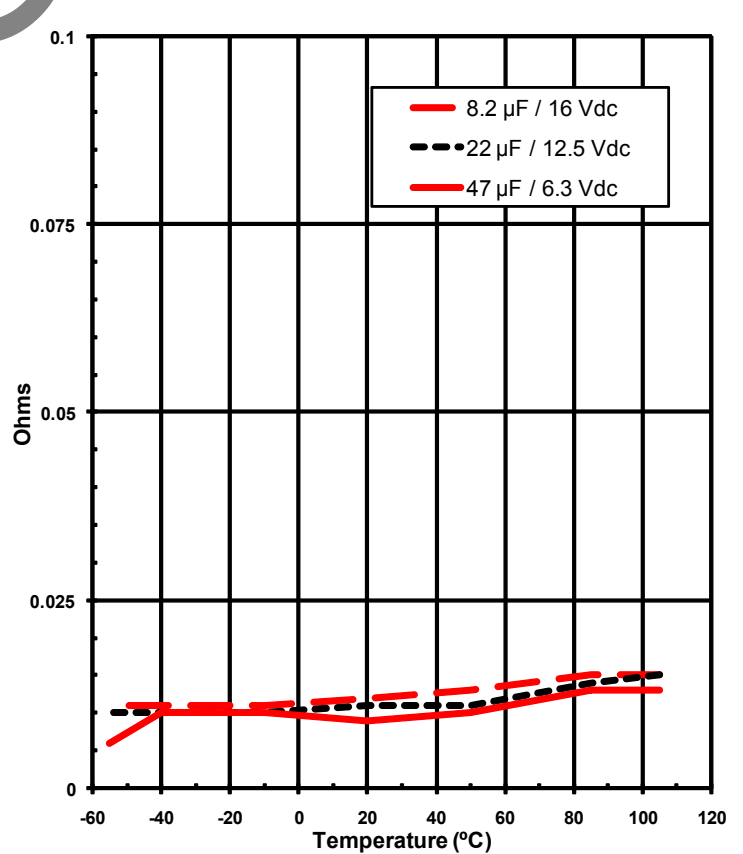

Solid Polymer Aluminum SMT Capacitors

Life Expectancy

Life Expectancy vs Temperature and Relative Humidity

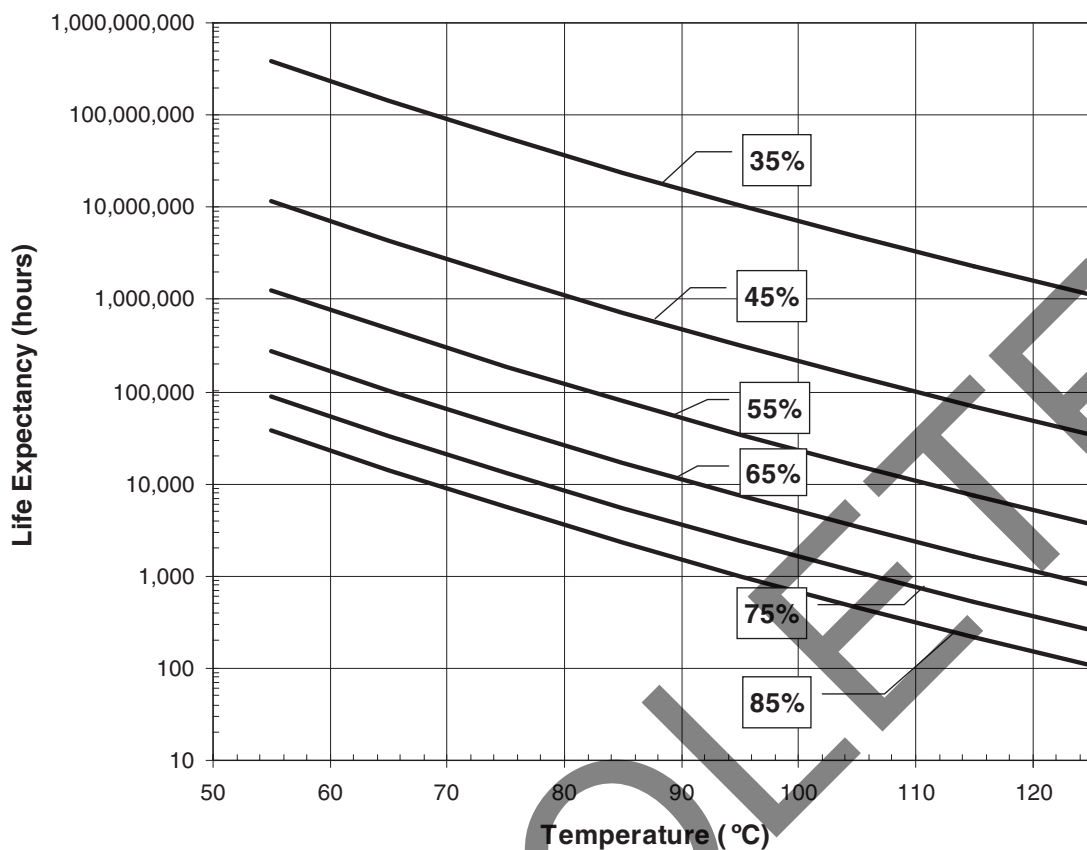

Endurance Test Data

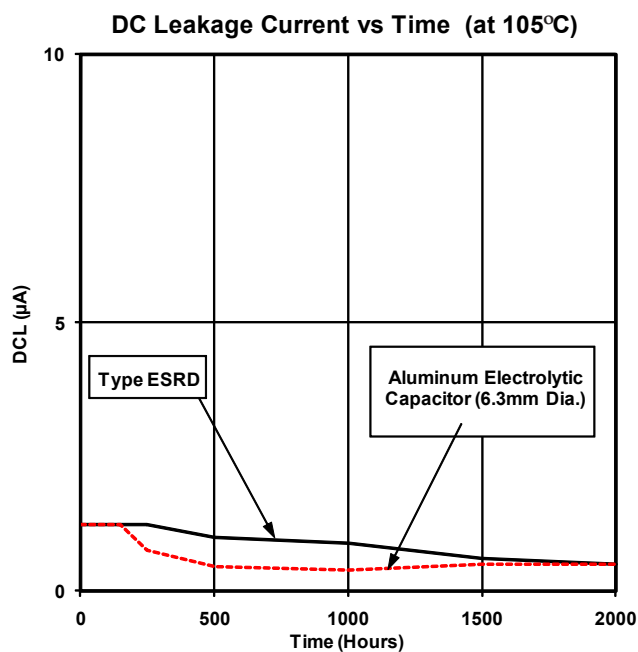
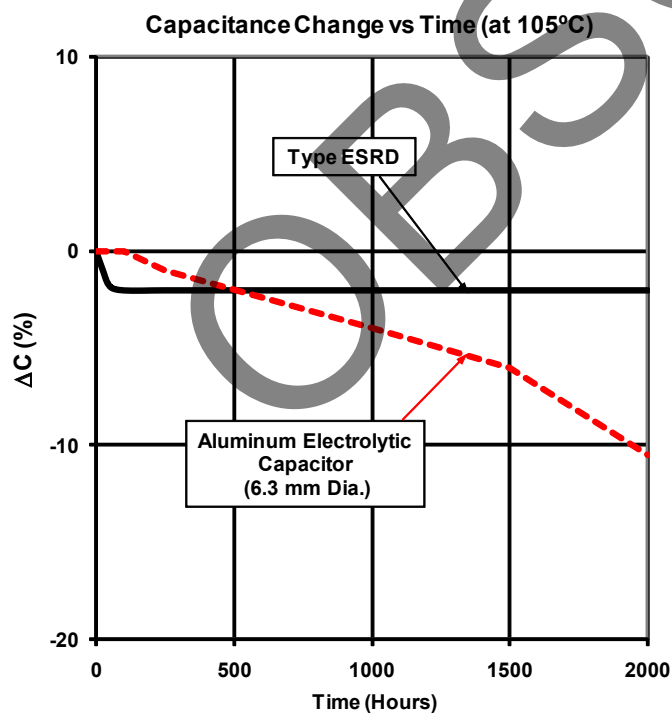

Solid Polymer Aluminum SMT Capacitors

Rated Voltage

This is the maximum voltage that the capacitor has been designed to withstand continuously at rated temperature. Solid Polymer Aluminum capacitors are quite rugged and may be operated continuously at rated voltage. Voltage derating does not significantly increase the life expectancy of the capacitor. At voltage levels equal to or less than rated voltage, the capacitor will not short circuit (even at end of life). In fact it can self heal. A polymer aluminum capacitor can be operated over a lifetime at full rated voltage without worry of short circuiting. However, if subjected to sufficient over voltage or reverse voltage, a Solid Polymer Aluminum capacitor can fail short circuit.

Ripple Current/Ripple Voltage

AC voltage as part of the capacitor's DC bias voltage will cause current to flow through the capacitor. This ripple current flows through the capacitor's equivalent series resistance generating heat. The heat increases the capacitor's internal temperature. Exceeding the specific maximum ripple current will overheat and damage the capacitor. The maximum ripple current

ratings are given in the ratings tables. Peaks of the AC ripple voltage should not exceed the rated voltage or cause voltage reversal.

Reverse Voltage

Solid Polymer Aluminum capacitors are polarized and are not intended to be used with reversed voltage. They can withstand reverse voltage pulses or transients up to 20% of the rated voltage, and they are capable of operating with up to 10% of the rated voltage when reverse voltage is applied continuously.

Shelf Life

When stored at room temperature, in low humidity, and out of direct sunlight, Solid Polymer Aluminum capacitors have a storage life of 5 to 10 years. Storage at high humidity over long periods of time can cause the DC leakage current to increase. However, the application of rated voltage will reduce the DC leakage current to normal limits.

Temperature Rise from Ripple Current
(47 μ F/6.3 Vdc)

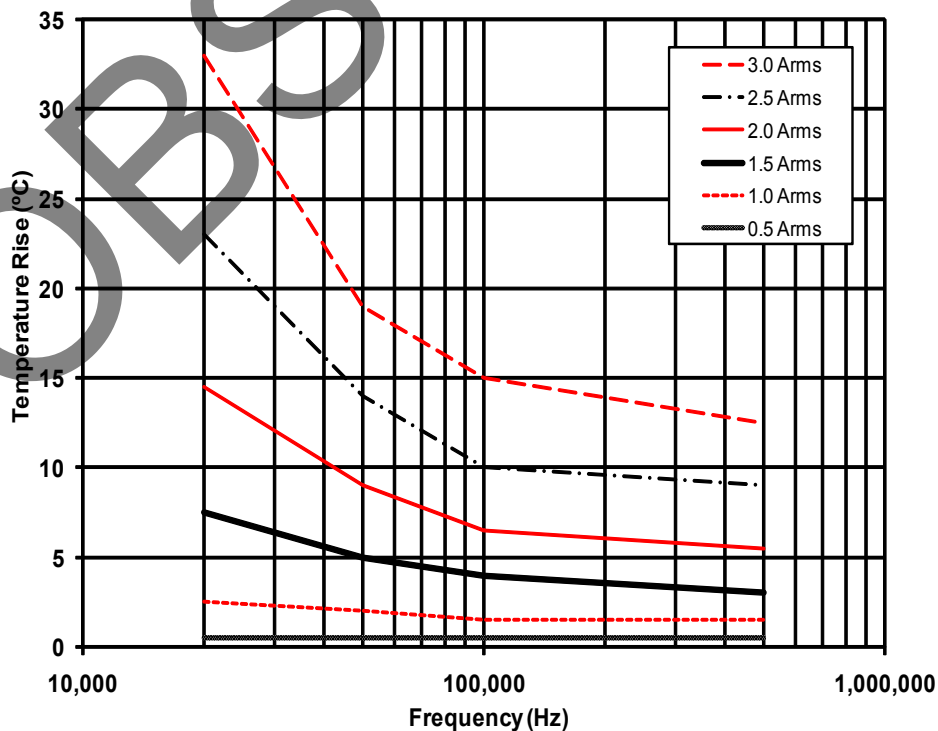

Solid Polymer Aluminum SMT Capacitors

Recommended Circuit Board Mounting Pads

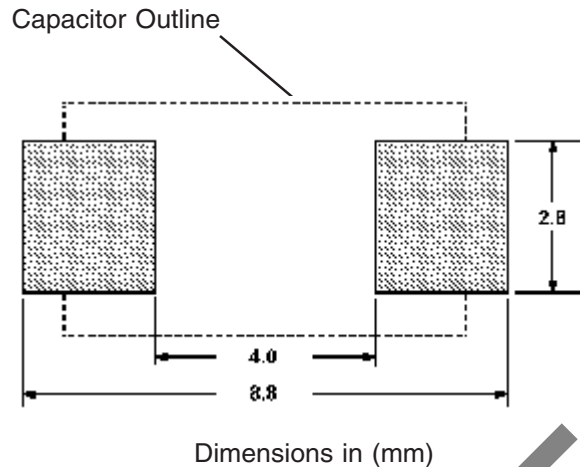

Reclamation

The resin case of a capacitor can be damaged by the heat stress of soldering if it has absorbed excessive moisture. Capacitors suspected of having been exposed to high humidity can be reclaimed by placing them in an oven at 50 °C for 100 Hours.

Heat Stress while Soldering

DC leakage current can increase after soldering, but it will return to the initial level after applying voltage. When using a soldering iron to mount the capacitor, the iron should have a maximum temperature of 350°C and soldering should not exceed 10 seconds.

Reflow Soldering

The graphs on the next page give the maximum recommended capacitor surface temperature during reflow soldering.

Cleaning

The capacitors can withstand for 5 minutes at 60 °C the following cleaning solvents by dipping or ultrasonic methods:

- Pine Alpha ST-100S
- Sunelec B-12
- DK Be-Clear CW-5790
- Aqua Cleaner 210SEP
- Cold Cleaner P3-375
- Telpen Cleaner EC-7R
- Clean-Thru 750H, 750L, and 710M
- Techno-Cleaner 219
- Techno-Care FRW-1, FRW-17, & FRV-1

After cleaning, wash the circuit board with water for about 3 minutes, and dry at 100 °C for 20 minutes.

Solid Polymer Aluminum SMT Capacitors

Reflow Soldering Profile, ESRD, ESRE, ESRH and SPA

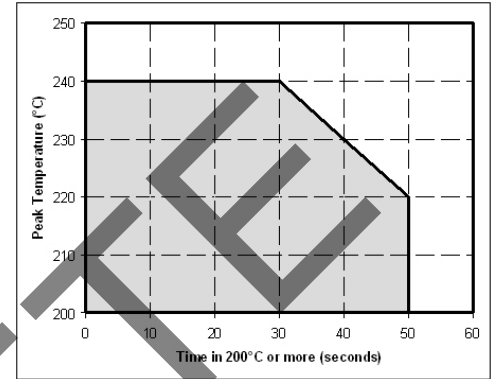
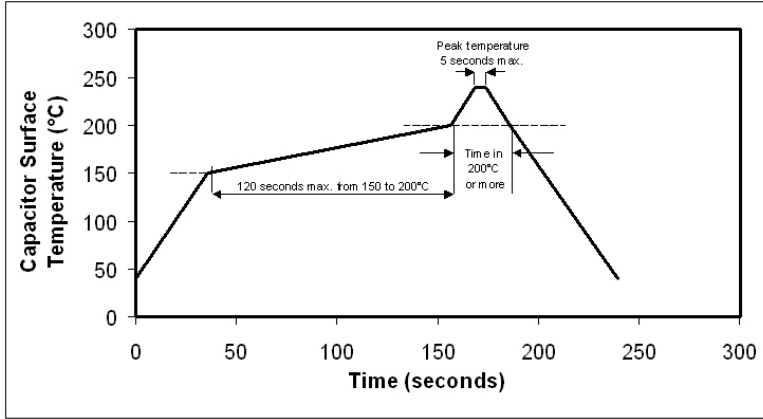

Reflow Soldering Profile, SPSX and SPCX

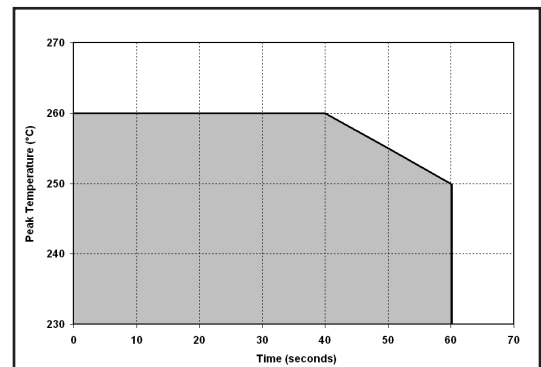
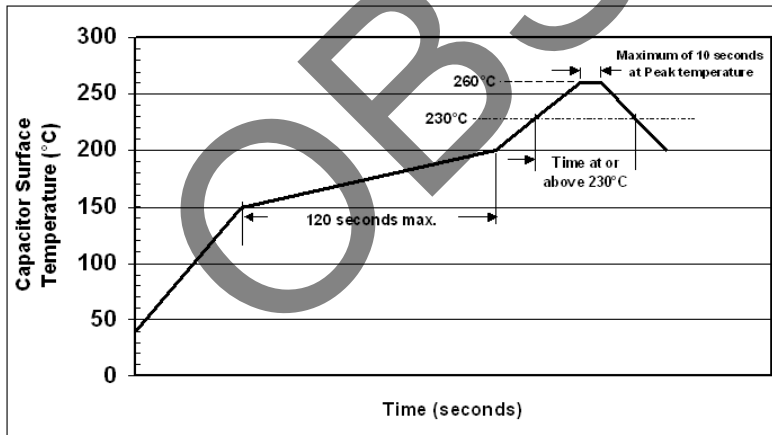

Solid Polymer Aluminum SMT Capacitors

Up to 50 Years Life

Solid Polymer Aluminum SMT capacitors are polarized, aluminum capacitors which use a highly conductive solid polymer as the electrolyte. They have reliability advantages over both aluminum and solid tantalum electrolytic capacitors. Unlike aluminum capacitors, there is no liquid electrolyte that can evaporate and cause a failure. Unlike solid tantalum which can fail short and burn, Solid Polymer Aluminum capacitors gradually become open circuits after 25 to 50 years operation.

Life expectancy curves show 200,000 hours expected life at full rated voltage and normal ambient conditions.

Ultra Low E.S.R. and High Ripple Current Capability

The equivalent series resistance (e.s.r.) of Solid Polymer Aluminum capacitors is much lower than the e.s.r. of solid tantalum capacitors. This results in a much higher ripple current handling capability. The e.s.r. is even lower than the new tantalum polymer hybrid capacitors. Solid Polymer Aluminum's ultra-low resistance magic is in the solid conductive polymer. The series resistance of electrolytic capacitors is largely determined by the resistivity of the electrolyte. Because the resistivity of Solid Polymer Aluminum's polymer electrolyte is several orders of magnitude less than that of other electrolytes, the equivalent series resistance is almost zero.

Construction

Construction is a unique combination of the elements of aluminum electrolytic and solid tantalum capacitors.

Like conventional aluminum electrolytic capacitors, the anode in Solid Polymer Aluminum capacitors is an aluminum plate on which an aluminum oxide layer has been built up by an electrolysis process. The aluminum oxide serves as the dielectric in both Solid Polymer Aluminum and conventional aluminum electrolytics.

The dielectric in solid tantalum capacitors is tantalum pentoxide which is built upon a tantalum pellet anode. A highly conductive polymer electrolyte film is deposited over the aluminum oxide dielectric in Solid Polymer Aluminum capacitors. Carbon and silver paint are used to finish the capacitor's cathode. This is similar to what is used in solid tantalum capacitors, where

manganese dioxide is used as the electrolyte.

The capacitor element is encased in a molded resin that is capable of meeting the UL-94,V0 flammability rating. The terminals are solder coated copper or copper clad steel.

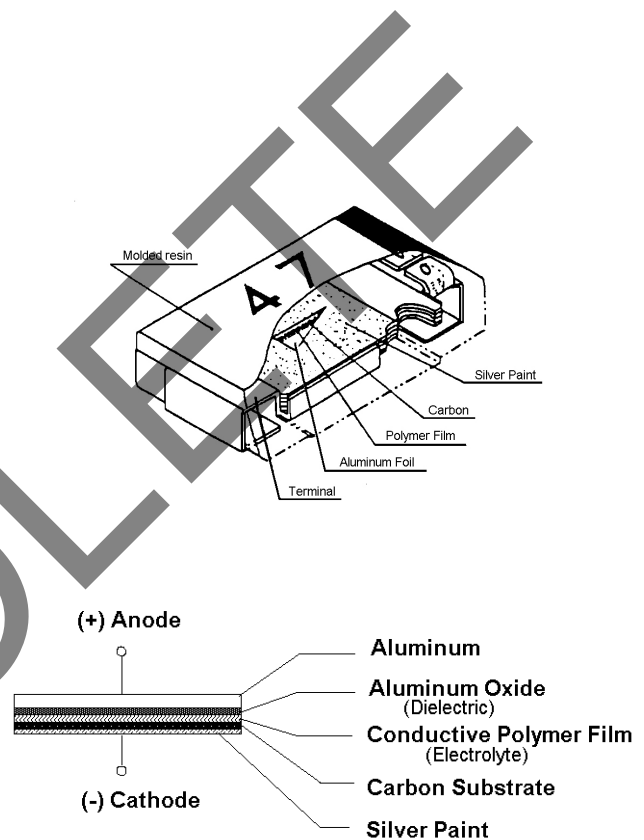

Solid Polymer Aluminum SMT Capacitors

Solid Polymer Aluminum Compared to Other Electrolytics

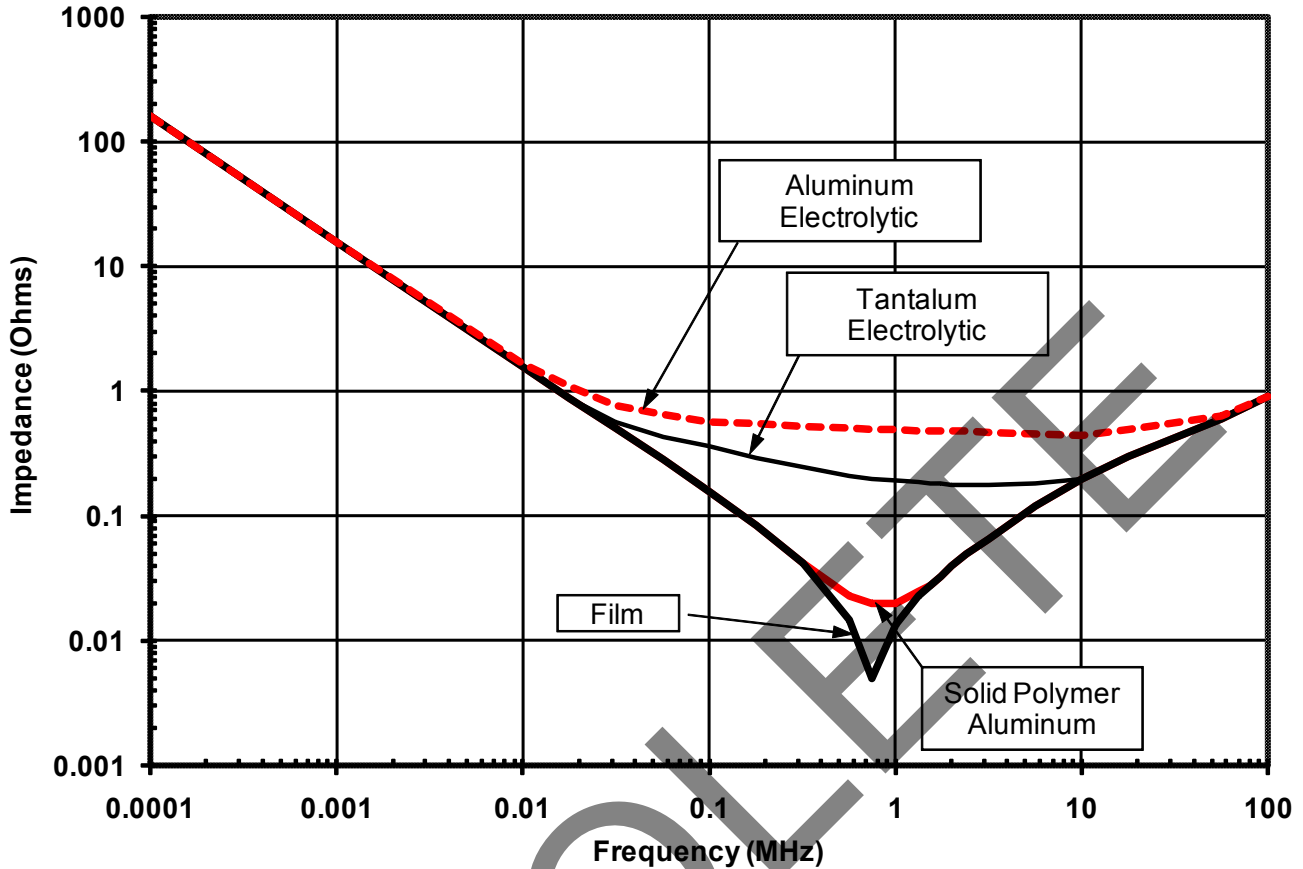

Solid Polymer Aluminum capacitors have lower impedance at high frequencies than the same values of wet electrolyte aluminum capacitors and solid tantalum capacitors.

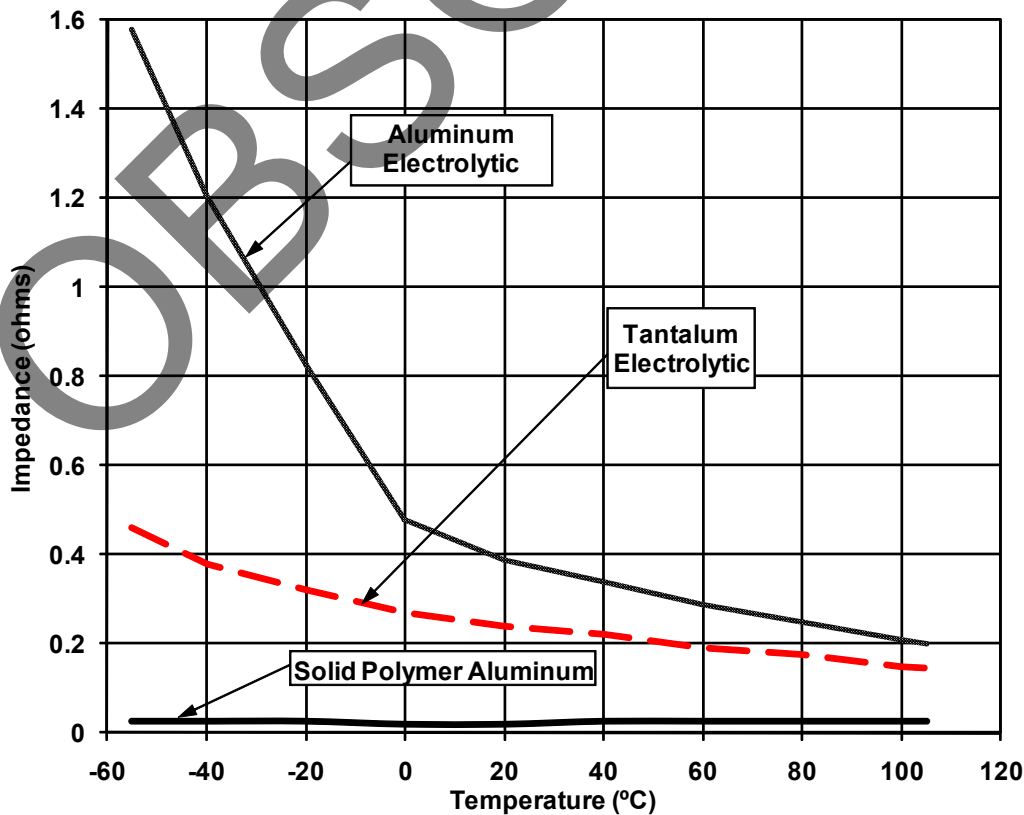

Solid Polymer Aluminum capacitors have stable impedance over the entire temperature range.

Solid Polymer Aluminum SMT Capacitors

Solid Polymer Aluminum vs Solid Tantalum

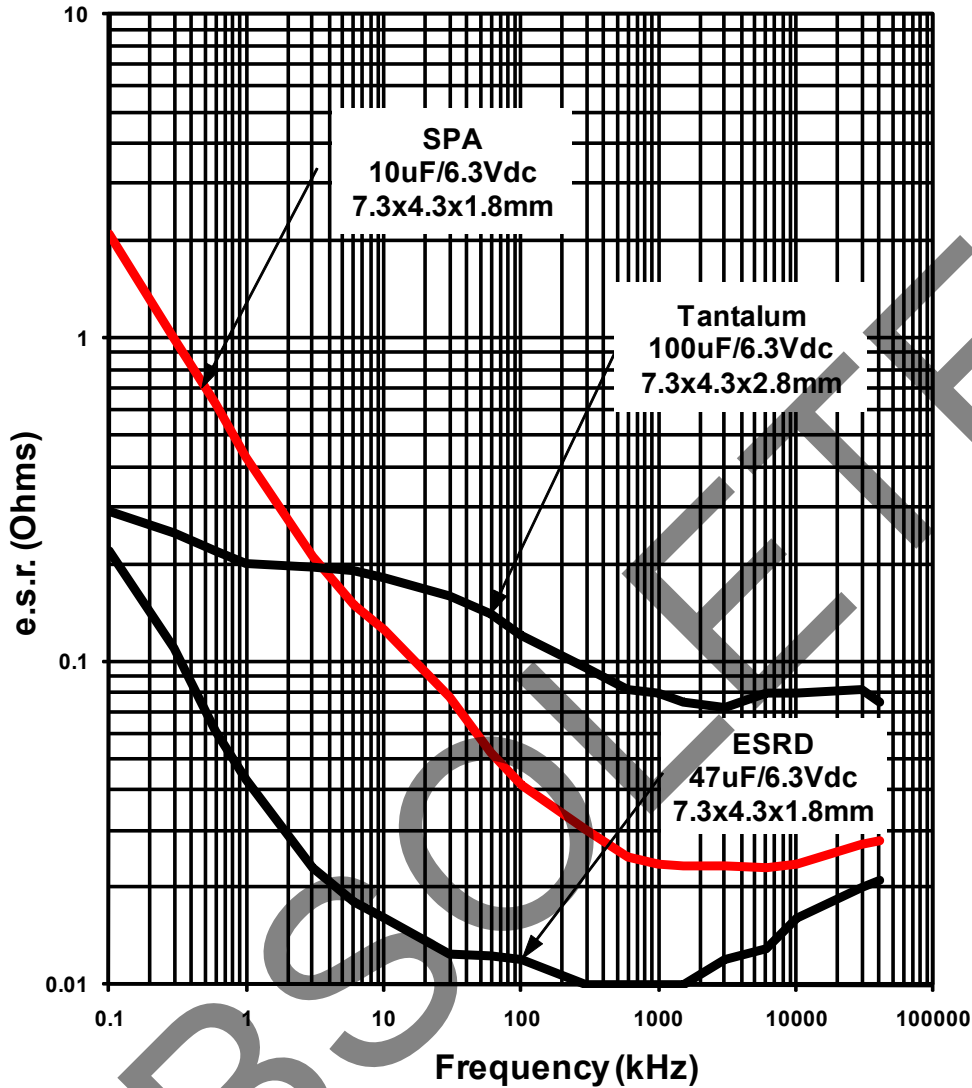

Frequency	100 μ F Tantalum Capacitor		47 μ F Solid Polymer Aluminum Electrolytic Capacitor	
	Equivalent Series Resistance	Impedance Magnitude Z	Equivalent Series Resistance	Impedance Magnitude Z
	(Ω)	(Ω)	(Ω)	(Ω)
100.0 kHz	0.12	0.12	0.012	0.035
1.0 MHz	0.08	0.08	0.010	0.010
100.0 Mhz	0.08	0.19	0.016	0.035

At 1 MHz the Solid Polymer Aluminum capacitor will provide almost 8 times more ripple and noise attenuation (.08/.01) as compared to the tantalum capacitor.

Solid Polymer Aluminum SMT Capacitors

Solid Polymer Aluminum vs Solid Tantalum-Polymer Hybrid

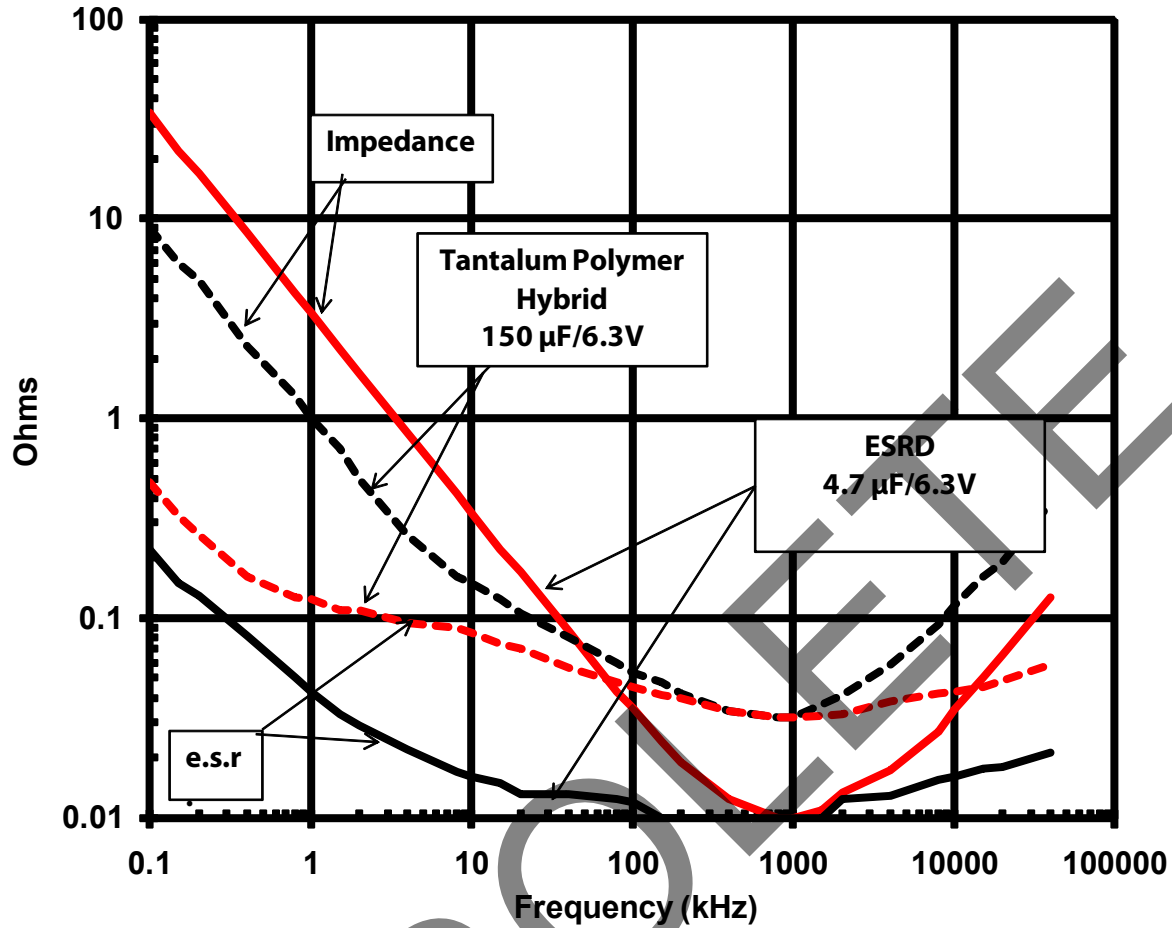

Type ESRD's impedance and equivalent series resistance are lower at high frequencies than that of tantalum-polymer hybrid type capacitors.

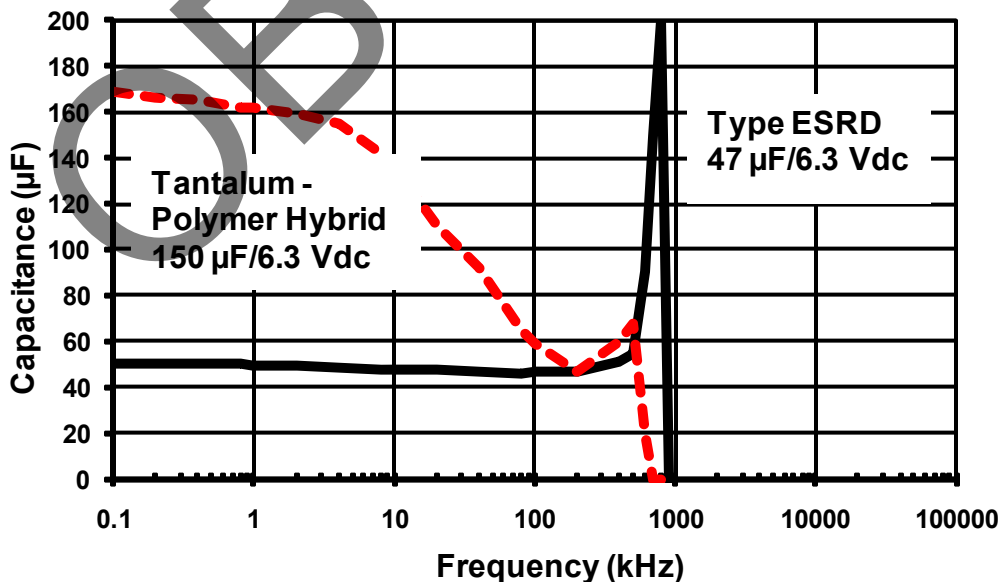



Note the capacitance roll off of the tantalum-polymer capacitor at high frequencies. The tantalum-polymer capacitor loses approximately 2/3 of its capacitance at 100 kHz.

Notice and Disclaimer: All product drawings, descriptions, specifications, statements, information and data (collectively, the "Information") in this datasheet or other publication are subject to change. The customer is responsible for checking, confirming and verifying the extent to which the Information contained in this datasheet or other publication is applicable to an order at the time the order is placed. All Information given herein is believed to be accurate and reliable, but it is presented without any guarantee, warranty, representation or responsibility of any kind, expressed or implied. Statements of suitability for certain applications are based on the knowledge that the Cornell Dubilier company providing such statements ("Cornell Dubilier") has of operating conditions that such Cornell Dubilier company regards as typical for such applications, but are not intended to constitute any guarantee, warranty or representation regarding any such matter – and Cornell Dubilier specifically and expressly disclaims any guarantee, warranty or representation concerning the suitability for a specific customer application, use, storage, transportation, or operating environment. The Information is intended for use only by customers who have the requisite experience and capability to determine the correct products for their application. Any technical advice inferred from this Information or otherwise provided by Cornell Dubilier with reference to the use of any Cornell Dubilier products is given gratis (unless otherwise specified by Cornell Dubilier), and Cornell Dubilier assumes no obligation or liability for the advice given or results obtained. Although Cornell Dubilier strives to apply the most stringent quality and safety standards regarding the design and manufacturing of its products, in light of the current state of the art, isolated component failures may still occur. Accordingly, customer applications which require a high degree of reliability or safety should employ suitable designs or other safeguards (such as installation of protective circuitry or redundancies or other appropriate protective measures) in order to ensure that the failure of an electrical component does not result in a risk of personal injury or property damage. Although all product-related warnings, cautions and notes must be observed, the customer should not assume that all safety measures are indicated in such warnings, cautions and notes, or that other safety measures may not be required.

OBSOLETE

Looking for pricing, stock, or lifecycle information?

Click below to explore more details on WIN SOURCE:

-  [View SPA391M0ER on WIN SOURCE](#)
-  [Cornell Dubilier Electronics \(CDE\) Information](#)

Optimize Your Supply Chain with WIN SOURCE Solutions

-  Global Sourcing Solution
-  Obsolete Management
-  Cost Control Management
-  Shortage Management
-  Alternative Solution
-  Excess Inventory Management