

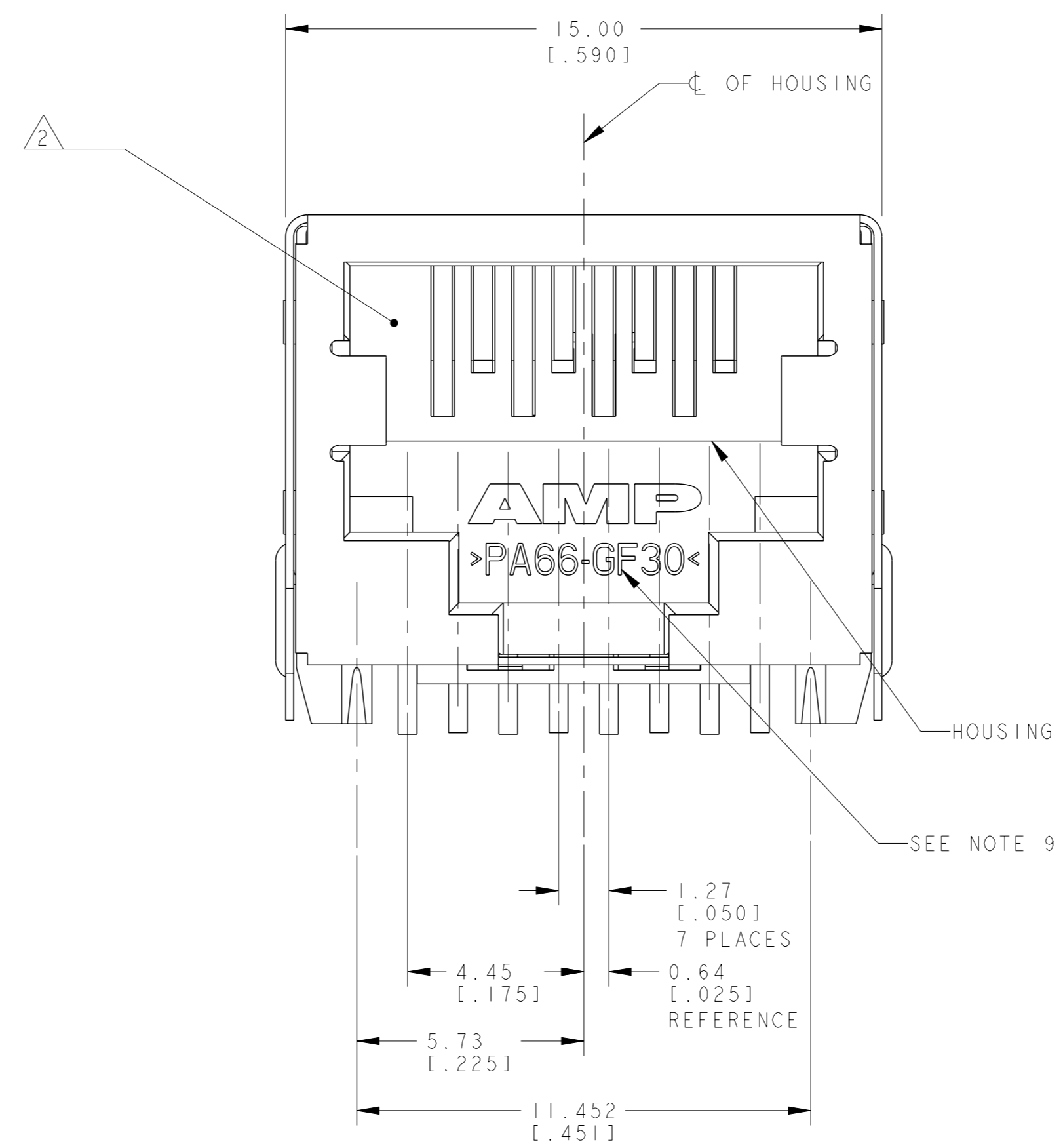

THE DATASHEET OF
1116503-2

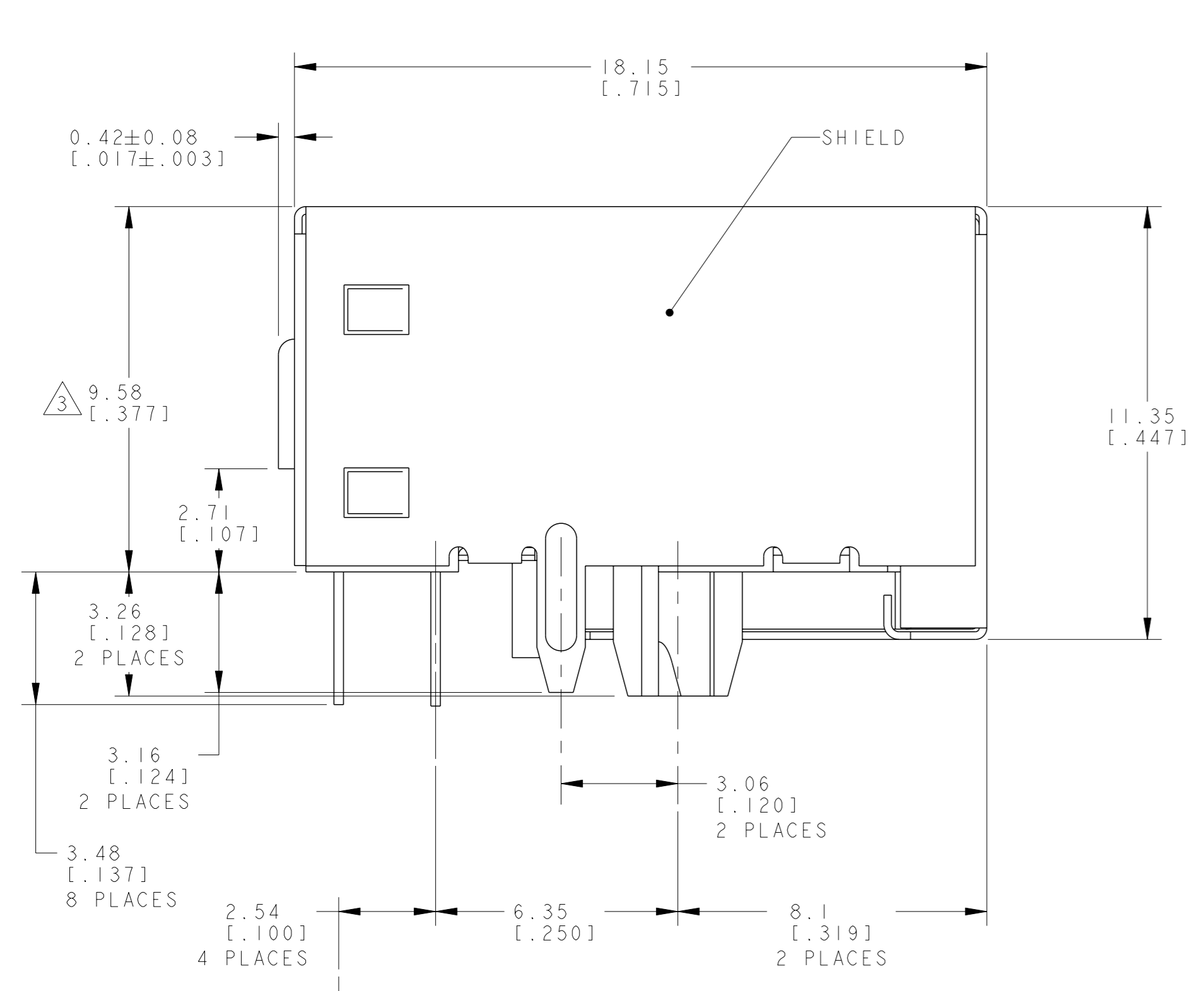

REVISONS		DATE	OWN	APVD
N1	REVISED PER ECO-11-005027	12MAY2011	RK	HMR
P	REVISED PER ECO-14-015233	27APR2015	LL	SH
R	ECO-16-011601	05AUG2016	LL	SH



- 1 MATERIAL: HOUSING - HIGH TEMPERATURE NYLON, BLACK, UL 94V-0, TERMINALS - 0.25[.01] THICK PHOSPHOR BRONZE PLATED WITH 3.81um(.000150) MINIMUM THICK BRIGHT TIN-LEAD IN SOLDER AREA, 1.27um(.000050) MINIMUM GOLD IN LOCALIZED PLATE AREA. ENTIRE TERMINAL PLATED WITH 1.27um(.000050) MINIMUM THICK NICKEL. SHIELD - 0.1[.0039] MIN THICK COPPER ZINC ALLOY, PREPLATED WITH 2.0-4.0um (.000079-.000157) THICK TIN OVER 1.27 um (.000050) MIN THICK NICKEL.
- 2 JACK CAVITY CONFORMS TO FCC RULES AND REGULATIONS PART 68, SUBPART F.
- 3 THIS DIMENSION REPRESENTS THE TOTAL HEIGHT OF THE CONNECTOR FROM THE TOP OF THE PC BOARD.
- 4. PACKAGED 66 ASSEMBLIES PER PVC TRAY, 396 PER BOX.
- 5. DIELECTRIC WITHSTANDING VOLTAGE BETWEEN SHIELD AND TERMINAL IS 1500 VAC.
- 6 MANUFACTURING DATE CODE:
ORIENTED AND LOCATED APPROXIMATELY AS SHOWN. LASER PRINTING.
TEXT HEIGHT APPROXIMATELY 2MM.
FIRST 2 DIGITS = LAST 2 DIGITS OF YEAR
NEXT 2 DIGITS = MANUFACTURING WORK WEEK
LAST DIGIT = DAY OF WEEK WITH SUNDAY = 1
- 7 MATERIAL: HOUSING - HIGH TEMPERATURE NYLON, BLACK, UL 94V-0, TERMINALS - 0.25[.01] THICK PHOSPHOR BRONZE PLATED WITH 3.81um(.000150) MINIMUM THICK MATTE TIN IN SOLDER AREA, 1.27um(.000050) MINIMUM GOLD IN LOCALIZED PLATE AREA. ENTIRE TERMINAL PLATED WITH 1.27um(.000050) MINIMUM THICK NICKEL. SHIELD - 0.1[.0039] MIN THICK COPPER ZINC ALLOY, PREPLATED WITH 2.0-4.0um (.000079-.000157) THICK TIN OVER 1.27 um (.000050) MIN THICK NICKEL.
- 8 MATERIAL: HOUSING - POLYESTER LCP, NATURE, UL 94V-0, TERMINALS - 0.25[.01] THICK PHOSPHOR BRONZE PLATED WITH 3.81um(.000150) MINIMUM THICK MATTE TIN IN SOLDER AREA, 1.27um(.000050) MINIMUM GOLD IN LOCALIZED PLATE AREA. ENTIRE TERMINAL PLATED WITH 1.27um(.000050) MINIMUM THICK NICKEL. SHIELD - 0.1[.0039] MIN THICK COPPER ZINC ALLOY, PREPLATED WITH 2.0-4.0um (.000079-.000157) THICK TIN OVER 1.27 um (.000050) MIN THICK NICKEL.
- 9 FOR 1116503-3 MATERIAL MARK: >LCP-GF30<.

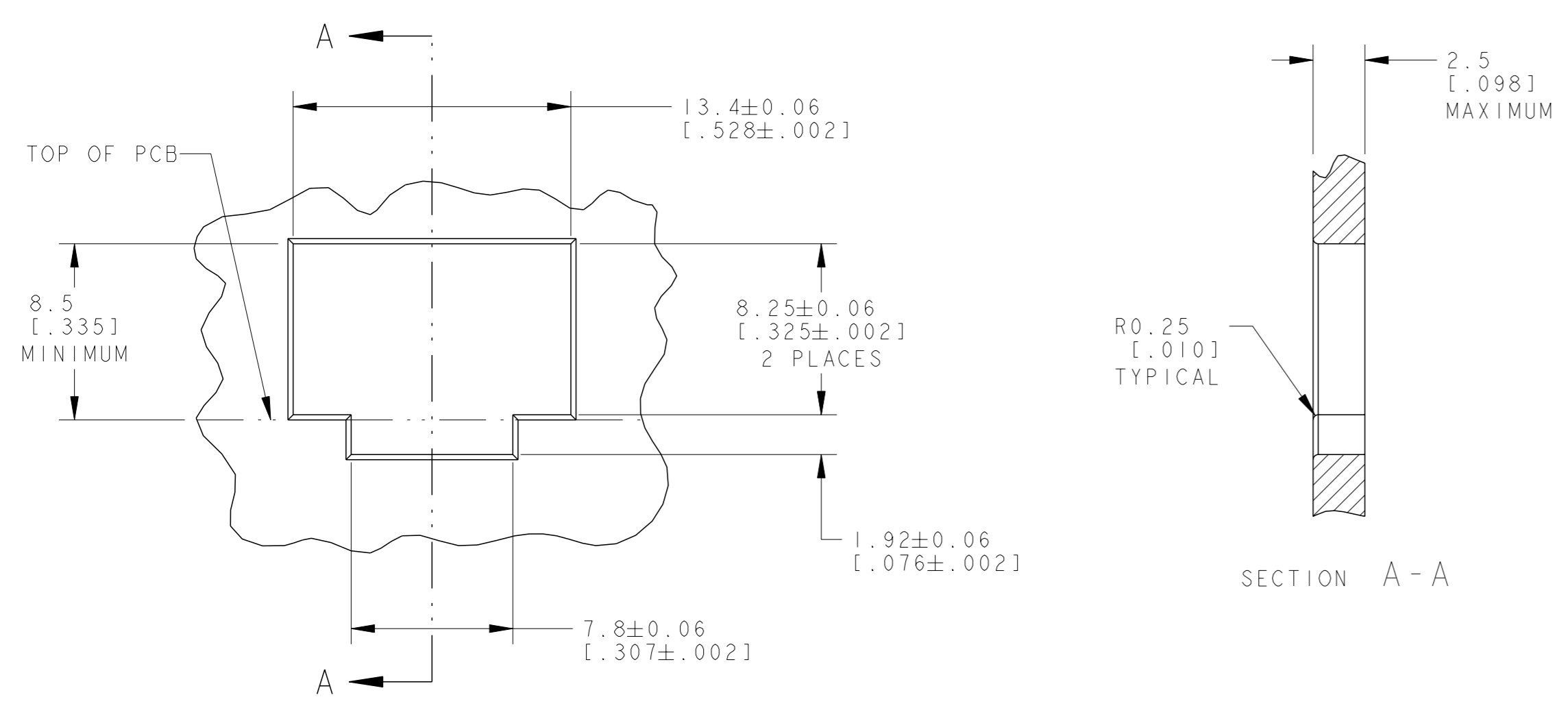
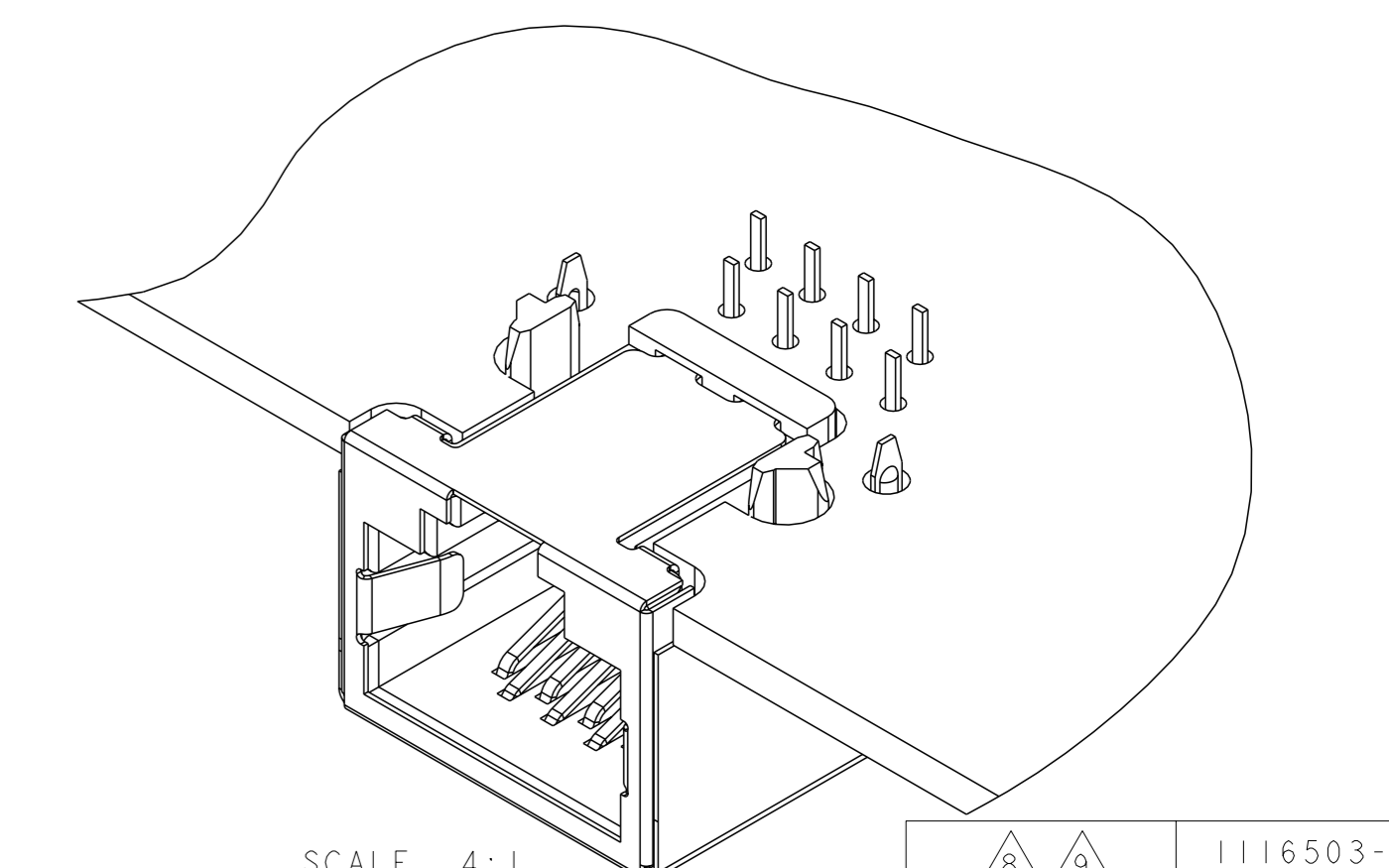
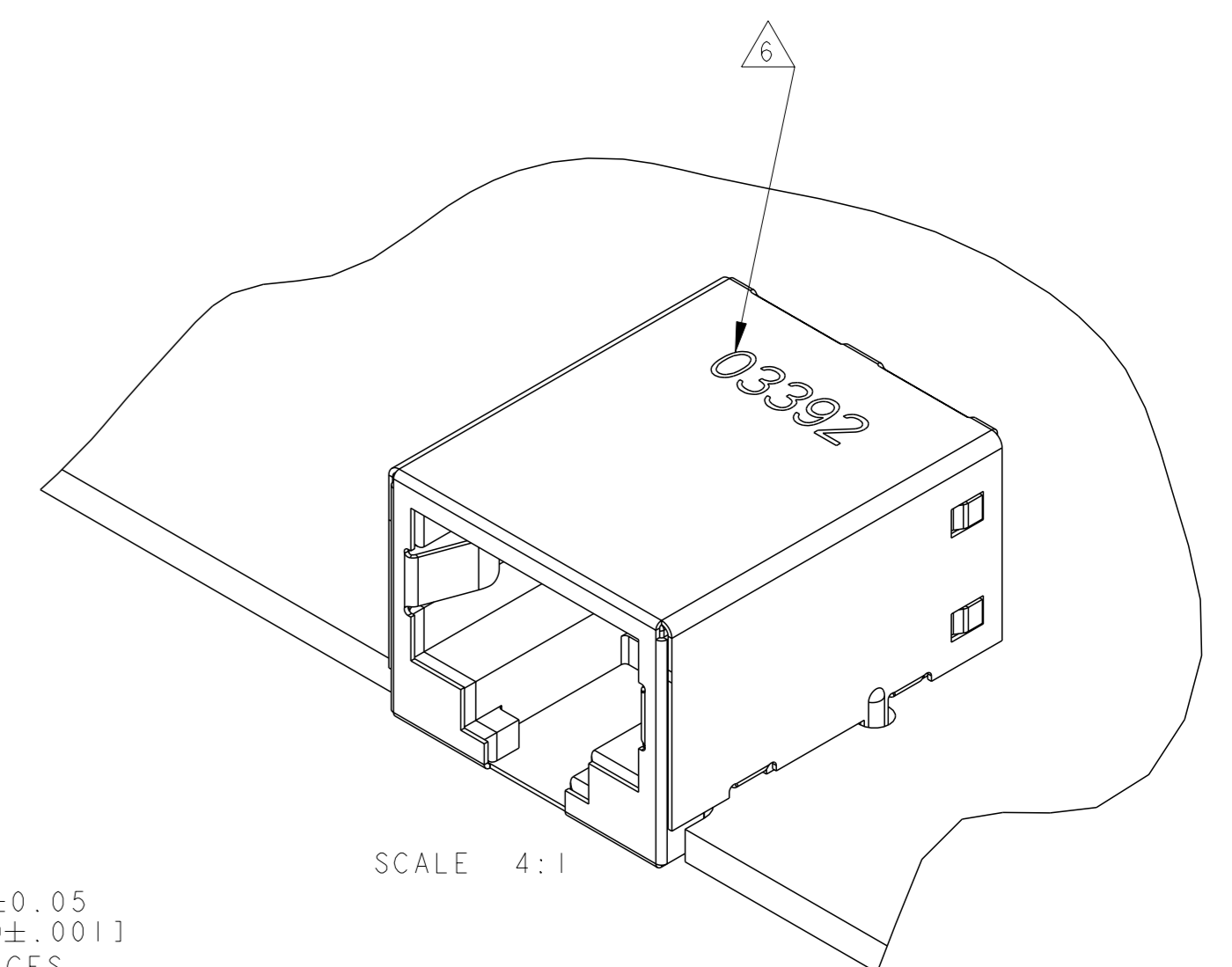
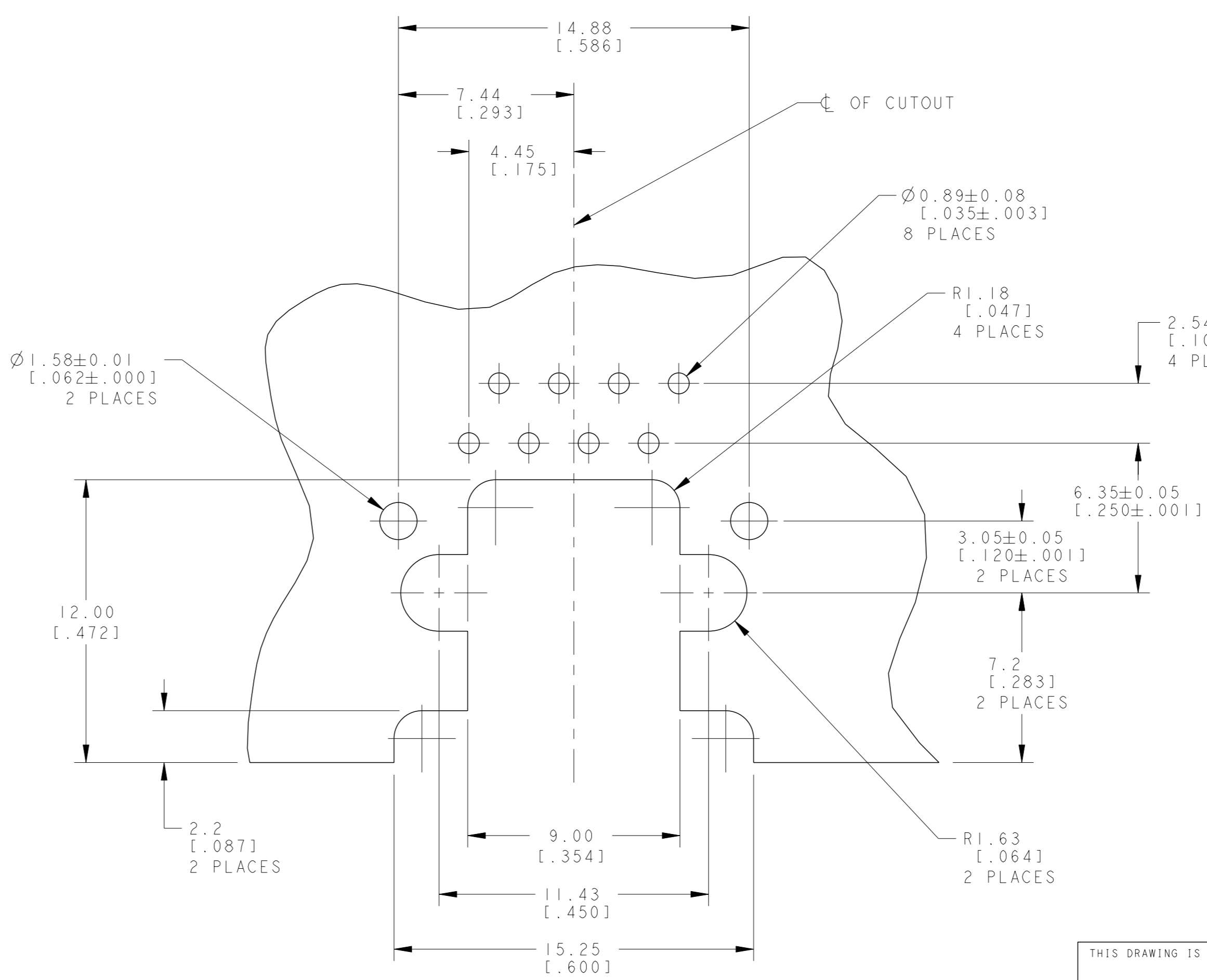
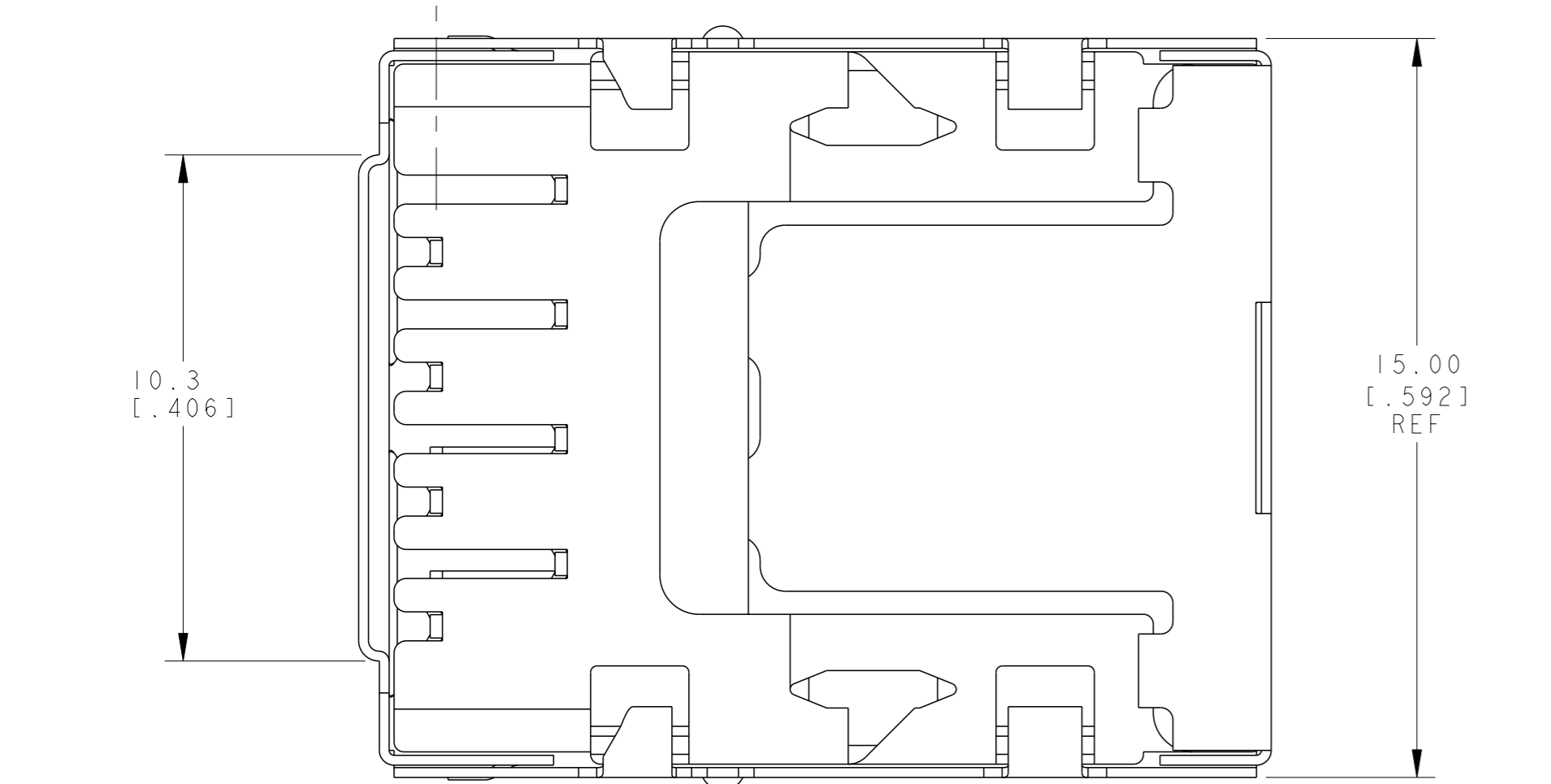

8	9	1116503-3
7		1116503-2
		1116503-1
MATERIAL / FINISH		PART NUMBER

THIS DRAWING IS A CONTROLLED DOCUMENT.		OWN: J. AHERON 07APR99	TE Connectivity	
DIMENSIONS: mm [INCHES]		CHK: D. KEMPKA 07APR99	NAME: MODULAR JACK ASSEMBLY, 8 POSITION, SHIELDED, 10mm WITHOUT PANEL TABS	
TOLERANCES UNLESS OTHERWISE SPECIFIED:		APVD: D. KEMPKA 07APR99	PRODUCT SPEC: 108-1163	
0 PLC	±	APPLICATION SPEC: 114-2048		
1 PLC	±	SIZE: 114-2048		
2 PLC	±0.131(.005)	RESTRICTED TO: -		
3 PLC	±	WEIGHT: 3.49 grams		
4 PLC	±	CAGE CODE: 1116503		
ANGLES	±	CUSTOMER DRAWING		
MATERIAL: SEE P/N TABLE	FINISH: SEE P/N TABLE	SCALE: 1:1 SHEET: 1 OF 1 REV: R		

Looking for pricing, stock, or lifecycle information?

Click below to explore more details on WIN SOURCE:

 [View 1116503-2 on WIN SOURCE](#)

 [TE Connectivity](#) Information

Optimize Your Supply Chain with WIN SOURCE Solutions

-  Global Sourcing Solution
-  Obsolete Management
-  Cost Control Management
-  Shortage Management
-  Alternative Solution
-  Excess Inventory Management