



**THE DATASHEET OF
SFT44T50-7.5J391E-0DU**



Type SF Dual, Round & Oval, Motor Run Capacitors

Metallized Polypropylene



Type SF dual rated oil filled motor run capacitors made with self-healing metallized polypropylene film are commonly used in air conditioning, motors and compressor applications. The dual ratings in a single can provide two capacitors - one may be used as a fan capacitor and the other as a compressor or motor run capacitor. Three terminals allow one terminal to act as a common while the other two are connected to the individual capacitors.

Highlights

- Fault current protection up to 10,000 A
- Low energy consumption — <0.1% DF
- Self healing
- cULus recognized under E71645
- Meets EIA Standard EIA-456-A
- 60,000 hours life
- Dry construction available upon request

Specifications [Click here to view hardware](#)

Capacitance Range	15-5 μ F to 80-10 μ F
Capacitance Tolerance	\pm 10% standard (\pm 6% and \pm 3% available)
Rated Voltage	370 Vac and 440 Vac
Operating Temperature Range with Ripple	-40 $^{\circ}$ C to 70 $^{\circ}$ C
Regulatory Information	

Service Life Objective

The service life objective for this series is 60,000 hours of operating life with a 94% survival rate when operated at full voltage, 60 Hz, and rated ambient temperature. AC capacitors are frequently used at voltages and ambient temperatures other than rated conditions. Service life may be estimated under specific conditions of temperature and voltage by using the curves as shown below and to the right.

Capacitance vs. Temperature

The Capacitance vs. Temperature curve may be used to determine the capacitance change as a function of temperature. Capacitance varies by no more than \pm 3% over the operating temperature range.

Life vs. Temperature



Life vs. Voltage

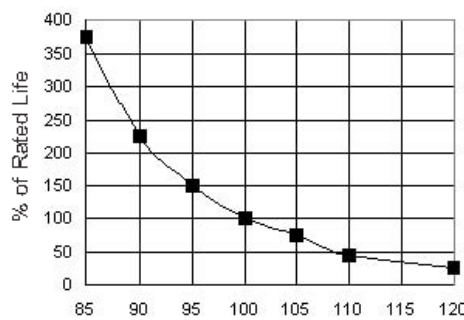

Capacitance vs. Temperature

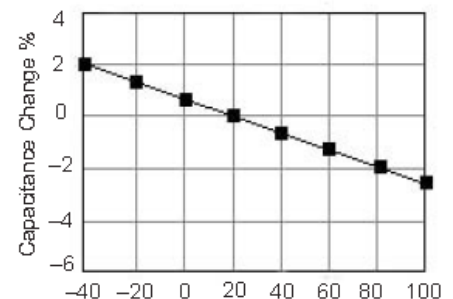

Part Numbering System

SF	C	37	T	15-5	K	291	E	-F
Type	Case	AC Volt	Case Material	Cap	Tol. \pm %	Can Height	VAR	RoHS
SF	C = 1 3/4" Oval D = 2.0" Oval S = 2.0" Round T = 2 1/2" Round	37 = 370 Vac 44 = 440 Vac X = Other	T = Aluminum w/steel cover	15-5 = 15-5 μ F 30-20 = 30-20 μ F 50-7.5 = 50-7.5 μ F	L = \pm 3% H = \pm 6% K = \pm 10% Z = +10 -5% X = Special	300 = 3.00" 388 = 3.88" 400 = 4.00" 475 = 4.75"	E = Dual 2,3,4 70 $^{\circ}$ C Z = Other	Compliant -F = Compliant

Type SF Dual, Round & Oval, Motor Run Capacitors

Type SF Dual Round

Case Code	D (Inches)	H
S	2.12	See Ratings Table
T	2.62	See Ratings Table

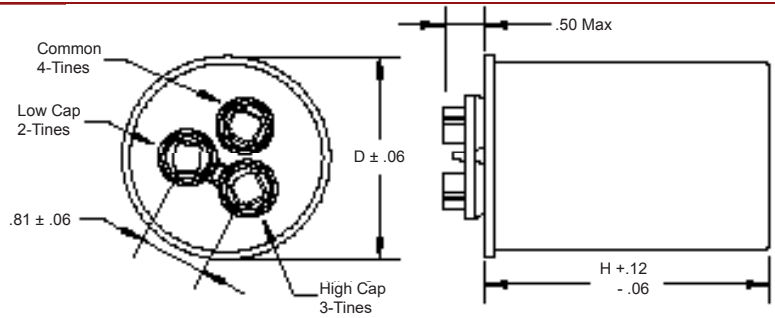

Ratings

Cap (μ F- μ F)	Case Code	Aluminum Catalog Part Number	H (in)	Cap (μ F- μ F)	Case Code	Aluminum Catalog Part Number	H (in)
370V				440V			
15-5	S	SFS37T15-5K291E-F	2.91	15-5	S	SFS44T15-5K291E-F	2.91
15-10	S	SFS37T15-10K291E-F	2.91	15-10	S	SFS44T15-10K291E-F	2.91
20-5	S	SFS37T20-5K291E-F	2.91	20-5	S	SFS44T20-5K291E-F	2.91
20-7.5	S	SFS37T20-7.5K291E-F	2.91	20-7.5	S	SFS44T20-7.5K291E-F	2.91
20-10	S	SFS37T20-10K291E-F	2.91	20-10	S	SFS44T20-10K291E-F	2.91
25-5	S	SFS37T25-5K291E-F	2.91	25-5	S	SFS44T25-5K291E-F	2.91
25-7.5	S	SFS37T25-7.5K291E-F	2.91	25-7.5	S	SFS44T25-7.5K384E-F	3.84
25-10	S	SFS37T25-10K291E-F	2.91	25-10	S	SFS44T25-10K384E-F	3.84
25-15	S	SFS37T25-15K384E-F	3.84	25-15	S	SFS44T25-15K384E-F	3.84
30-5	S	SFS37T30-5K291E-F	2.91	30-5	S	SFS44T30-5K384E-F	3.84
30-7.5	S	SFS37T30-7.5K384E-F	3.84	30-7.5	S	SFS44T30-7.5K384E-F	3.84
30-10	S	SFS37T30-10K384E-F	3.84	30-10	S	SFS44T30-10K384E-F	3.84
30-15	S	SFS37T30-15K384E-F	3.84	30-15	S	SFS44T30-15K475E-F	4.75
30-20	S	SFS37T30-20K384E-F	3.84	30-20	S	SFS44T30-20K475E-F	4.75
35-5	S	SFS37T35-5K384E-F	3.84	35-5	S	SFS44T35-5K384E-F	3.84
35-7.5	S	SFS37T35-7.5K384E-F	3.84	35-7.5	T	SFT44T35-7.5K291E-F	2.91
35-10	S	SFS37T35-10K384E-F	3.84	35-10	T	SFT44T35-10K291E-F	2.91
35-15	S	SFS37T35-15K384E-F	3.84	35-15	T	SFT44T35-15K291E-F	2.91
35-20	S	SFS37T35-20K475E-F	4.75	35-20	T	SFT44T35-20K391E-F	3.91
40-5	S	SFS37T40-5K384E-F	3.84	40-5	T	SFT44T40-5K291E-F	2.91
40-7.5	S	SFS37T40-7.5K384E-F	3.84	40-7.5	T	SFT44T40-7.5K291E-F	2.91
40-10	S	SFS37T40-10K384E-F	3.84	40-10	T	SFT44T40-10K291E-F	2.91
40-15	S	SFS37T40-15K475E-F	4.75	40-15	T	SFT44T40-15K391E-F	3.91
45-5	S	SFS37T45-5K384E-F	3.84	45-5	T	SFT44T45-5K291E-F	2.91
45-7.5	S	SFS37T45-7.5K384E-F	3.84	45-7.5	T	SFT44T45-7.5K291E-F	2.91
45-10	S	SFS37T45-10K475E-F	4.75	45-10	T	SFT44T45-10K391E-F	3.91
45-15	S	SFS37T45-15K475E-F	4.75	45-15	T	SFT44T45-15K391E-F	3.91
50-5	T	SFT37T50-5K291E-F	2.91	50-5	T	SFT44T50-5K391E-F	3.91
50-7.5	T	SFT37T50-7.5K291E-F	2.91	50-7.5	T	SFT44T50-7.5K391E-F	3.91
50-10	T	SFT37T50-10K291E-F	2.91	50-10	T	SFT44T50-10K391E-F	3.91
60-5	T	SFT37T60-5K291E-F	2.91	60-5	T	SFT44T60-5K391E-F	3.91
60-7.5	T	SFT37T60-7.5K291E-F	2.91	60-7.5	T	SFT44T60-7.5K391E-F	3.91
60-10	T	SFT37T60-10K291E-F	2.91	60-10	T	SFT44T60-10K391E-F	3.91
70-5	T	SFT37T70-5K391E-F	3.91				
70-7.5	T	SFT37T70-7.5K391E-F	3.91				
70-10	T	SFT37T70-10K391E-F	3.91				
80-5	T	SFT37T80-5K391E-F	3.91				
80-7.5	T	SFT37T80-7.5K391E-F	3.91				
80-10	T	SFT37T80-10K391E-F	3.91				

Type SF Dual, Round & Oval, Motor Run Capacitors

Type SF Dual Oval

Case Code	Dimensions (Inches)		
	A	B	H
C	1.91	2.91	See Ratings Table
D	1.97	3.66	See Ratings Table

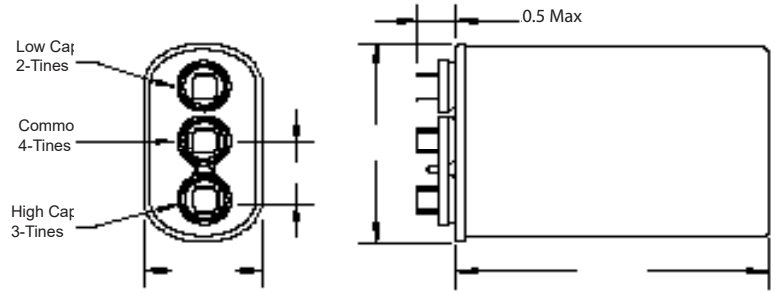

Ratings

Cap (μF-μF)	Case Code	Aluminum Catalog Part Number	H (in)
370V			
15-5	C	SFC37T15-5K291E-F	2.91
15-10	C	SFC37T15-10K291E-F	2.91
20-5	C	SFC37T20-5K291E-F	2.91
20-7.5	C	SFC37T20-7.5K291E-F	2.91
20-10	C	SFC37T20-10K291E-F	2.91
25-5	C	SFC37T25-5K291E-F	2.91
25-7.5	C	SFC37T25-7.5K291E-F	2.91
25-10	C	SFC37T25-10K291E-F	2.91
25-15	C	SFC37T25-15K391E-F	3.91
30-5	C	SFC37T30-5K391E-F	3.91
30-7.5	C	SFC37T30-7.5K391E-F	3.91
30-10	C	SFC37T30-10K391E-F	3.91
30-15	C	SFC37T30-15K391E-F	3.91
30-20	C	SFC37T30-20K391E-F	3.91
35-5	C	SFC37T35-5K391E-F	3.91
35-7.5	C	SFC37T35-7.5K391E-F	3.91
35-10	C	SFC37T35-10K391E-F	3.91
35-15	C	SFC37T35-15K391E-F	3.91
35-20	C	SFC37T35-20K391E-F	3.91
40-5	C	SFC37T40-5K391E-F	3.91
40-7.5	C	SFC37T40-7.5K391E-F	3.91
40-10	C	SFC37T40-10K391E-F	3.91
40-15	D	SFD37T40-15K391E-F	3.91
45-5	D	SFD37T45-5K391E-F	3.91
45-7.5	D	SFD37T45-7.5K391E-F	3.91
45-10	D	SFD37T45-10K391E-F	3.91
45-15	D	SFD37T45-15K391E-F	3.91
50-5	D	SFD37T50-5K391E-F	3.91
50-7.5	D	SFD37T50-7.5K391E-F	3.91
50-10	D	SFD37T50-10K391E-F	3.91
60-5	D	SFD37T60-5K475E-F	4.75
60-7.5	D	SFD37T60-7.5K475E-F	4.75
60-10	D	SFD37T60-10K475E-F	4.75
70-5	D	SFD37T70-5K475E-F	4.75
70-7.5	D	SFD37T70-7.5K475E-F	4.75
70-10	D	SFD37T70-10K475E-F	4.75
80-5	D	SFD37T80-5K475E-F	4.75
80-7.5	D	SFD37T80-7.5K475E-F	4.75
80-10	D	SFD37T80-10K475E-F	4.75

Cap (μF-μF)	Case Code	Aluminum Catalog Part Number	H (in)
440V			
15-5	C	SFC44T15-5K291E-F	2.91
15-10	C	SFC44T15-10K291E-F	2.91
20-5	C	SFC44T20-5K291E-F	2.91
20-7.5	C	SFC44T20-7.5K291E-F	2.91
20-10	C	SFC44T20-10K291E-F	2.91
25-5	C	SFC44T25-5K391E-F	3.91
25-7.5	C	SFC44T25-7.5K391E-F	3.91
25-10	C	SFC44T25-10K391E-F	3.91
25-15	C	SFC44T25-15K391E-F	3.91
30-5	C	SFC44T30-5K391E-F	3.91
30-7.5	C	SFC44T30-7.5K391E-F	3.91
30-10	C	SFC44T30-10K391E-F	3.91
30-15	C	SFC44T30-15K391E-F	3.91
30-20	C	SFC44T30-20K391E-F	3.91
35-5	C	SFC44T35-5K475E-F	4.75
35-7.5	C	SFC44T35-7.5K475E-F	4.75
35-10	C	SFC44T35-10K475E-F	4.75
35-15	C	SFC44T35-15K475E-F	4.75
35-20	C	SFC44T35-20K475E-F	4.75
40-5	D	SFD44T40-5K475E-F	4.75
40-7.5	D	SFD44T40-7.5K475E-F	4.75
40-10	D	SFD44T40-10K475E-F	4.75
40-15	D	SFD44T40-15K475E-F	4.75
45-5	D	SFD44T45-5K475E-F	4.75
45-7.5	D	SFD44T45-7.5K475E-F	4.75
45-10	D	SFD44T45-10K475E-F	4.75
45-15	D	SFD44T45-15K475E-F	4.75
50-5	D	SFD44T50-5K475E-F	4.75
50-7.5	D	SFD44T50-7.5K475E-F	4.75
50-10	D	SFD44T50-10K475E-F	4.75
60-5	D	SFD44T60-5K616E-F	6.16
60-7.5	D	SFD44T60-7.5K616E-F	6.16
60-10	D	SFD44T60-10K616E-F	6.16



*

Type SF Dual, Round & Oval, Motor Run Capacitors

Notice and Disclaimer: All product drawings, descriptions, specifications, statements, information and data (collectively, the “Information”) in this datasheet or other publication are subject to change. The customer is responsible for checking, confirming and verifying the extent to which the Information contained in this datasheet or other publication is applicable to an order at the time the order is placed. All Information given herein is believed to be accurate and reliable, but it is presented without any guarantee, warranty, representation or responsibility of any kind, expressed or implied. Statements of suitability for certain applications are based on the knowledge that the Cornell Dubilier company providing such statements (“Cornell Dubilier”) has of operating conditions that such Cornell Dubilier company regards as typical for such applications, but are not intended to constitute any guarantee, warranty or representation regarding any such matter – and Cornell Dubilier specifically and expressly disclaims any guarantee, warranty or representation concerning the suitability for a specific customer application, use, storage, transportation, or operating environment. The Information is intended for use only by customers who have the requisite experience and capability to determine the correct products for their application. Any technical advice inferred from this Information or otherwise provided by Cornell Dubilier with reference to the use of any Cornell Dubilier products is given gratis (unless otherwise specified by Cornell Dubilier), and Cornell Dubilier assumes no obligation or liability for the advice given or results obtained. Although Cornell Dubilier strives to apply the most stringent quality and safety standards regarding the design and manufacturing of its products, in light of the current state of the art, isolated component failures may still occur. Accordingly, customer applications which require a high degree of reliability or safety should employ suitable designs or other safeguards (such as installation of protective circuitry or redundancies or other appropriate protective measures) in order to ensure that the failure of an electrical component does not result in a risk of personal injury or property damage. Although all product-related warnings, cautions and notes must be observed, the customer should not assume that all safety measures are indicated in such warnings, cautions and notes, or that other safety measures may not be required.

Looking for pricing, stock, or lifecycle information?

Click below to explore more details on WIN SOURCE:

-  [View SFT44T50-7.5J391E-0DU on WIN SOURCE](#)
-  [Cornell Dubilier Electronics \(CDE\) Information](#)

Optimize Your Supply Chain with WIN SOURCE Solutions

-  Global Sourcing Solution
-  Obsolete Management
-  Cost Control Management
-  Shortage Management
-  Alternative Solution
-  Excess Inventory Management