



**THE DATASHEET OF
DCK-3R3E404T-E**



Coin Cell Capacitors

GREEN CAP 60°C / 70°C

- Small-sized, but large capacity.
- Unlike batteries, unlimited charge/discharge cycles; ideal for solar watches, solar calculators, solar remote control units, camaras and the like.

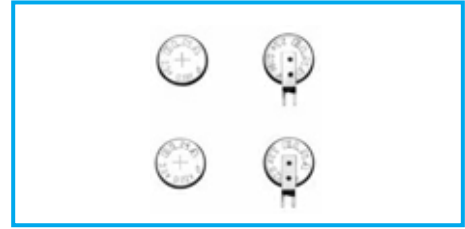
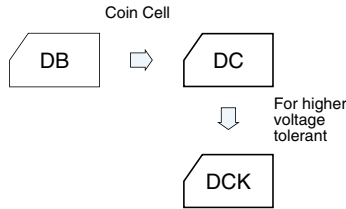

Specifications

Item	Performance			
	DC series		DCK series	
Series Name	DC series		DCK series	
Rated voltage (V)	2.5		3.3	
Category temperature range (°C)	-25 to +70		-10 to +60	
Tolerance at rated capacitance (%)	-20 to +80		-20 to +80	
Rated Capacitance (F)	0.22		0.22	
Internal resistance(Ω) at 1 kHz	100		200	
Characteristics at high and low temperature	Percentage of capacitance change	Within ±30% of the value at 20°C	Percentage of capacitance change	Within ±50% of the value at 20°C
	Internal resistance	Less than five times of the value at 20°C	Internal resistance	Within five times the initial specified value
Endurance	Test temperature	70°C	Test temperature	60°C
	Test time	1000 hours	Test time	1000 hours
	Percentage of capacitance change	Within ±30% of the initial measured value	Percentage of capacitance change	Within ±30% of the initial measured value
	Internal resistance	Within four times of the initial specified value	Internal resistance	Within four times of the initial specified value
Shelf life	Test time :1000 hours ; Same as endurance.			

Outline Drawing

Unit: mm

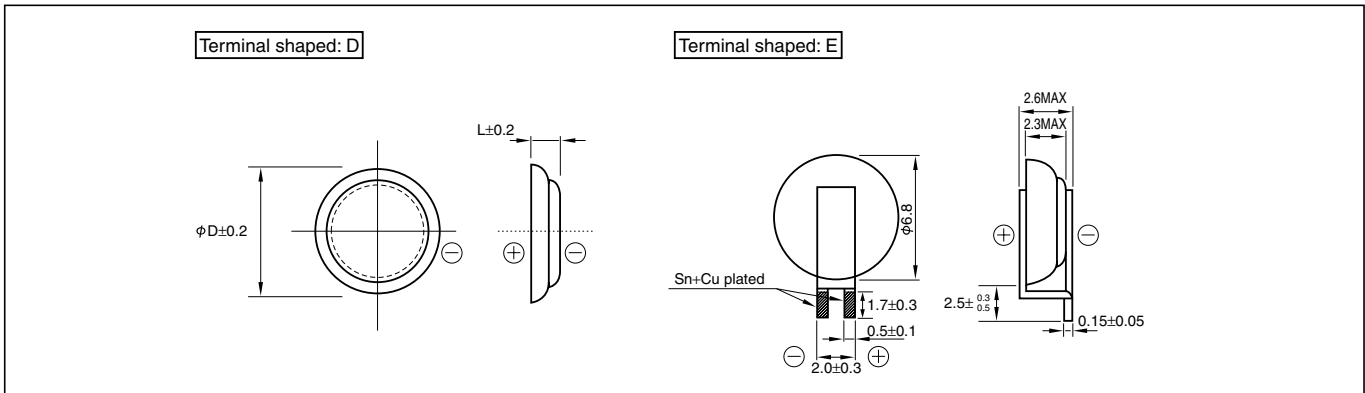

Part numbering system (example: 2.5V0.22F, terminal shaped: E)

DC	—	2R5	E	224	□	—	E
Series code		Rated voltage symbol		Rated capacitance symbol	Additional symbol		

Part number is refer to below table.

Part numbering system (example: 3.3V0.22F, terminal shaped: E)



DCK	—	3R3	E	224	□	—	E
Series code		Rated voltage symbol		Rated capacitance symbol	Additional symbol		

Standard Ratings





Max. operating voltage(V)	Rated capacitance(F)	ELNA Parts No.	φ DxL(mm)
2.5	0.22	DC-2R5D224	6.8x2.1
		DC-2R5E224U-E	
3.3	0.22	DCK-3R3D224	6.8x2.1
		DCK-3R3E224U-E	

Looking for pricing, stock, or lifecycle information?

Click below to explore more details on WIN SOURCE:

-  [View DCK-3R3E404T-E on WIN SOURCE](#)
-  [Elna America Information](#)

Optimize Your Supply Chain with WIN SOURCE Solutions

-  Global Sourcing Solution
-  Obsolete Management
-  Cost Control Management
-  Shortage Management
-  Alternative Solution
-  Excess Inventory Management