



**THE DATASHEET OF
SFC48S15L291K-F**



Type SF Lighting Capacitors, 90 °C Rated

AC Rated, Metallized Polypropylene Capacitors



For better performance in HID Lighting and HV Ballasts, Type SF oval and round oil filled metallized polypropylene lighting capacitors are built for operating in the high temperature environments for high intensity discharge (HID) lighting and other high voltage ballast applications. Each HID catalog capacitor includes an external resistor that discharges the capacitor to less than 50V in one minute.

Highlights

- Casing: aluminum
- Paint: (U. L. recognized) optional
- Meets EIA Standard EIA-456-A
- cULus recognized File Number E71645

Specifications

[Click here to view hardware](#)

Capacitance Range	5.0 μ F to 55 μ F
Capacitance Tolerance	\pm 3%
Rated Voltage	280 Vac to 525 Vac, other voltages available
Operating Temperature Range with Ripple	-40 °C to +90 °C
Operating Frequency	50 - 60 Hz
Regulatory Information	

Part Numbering System

SF	C	40	T	15	L	291	K	-F
Type	Case Size	Voltage	Case Matl.	Cap	Tolerance	Can Height	Terminals	RoHS
SF	A = 1 1/4" Oval B = 1 1/2" Oval C = 1 3/4" Oval D = 2.0" Oval P = 1 3/4" Round S = 2.0" Round T = 2 1/2" Round	28 = 280 Vac 30 = 300 Vac 33 = 330 Vac 40 = 400 Vac 48 = 480 Vac 52 = 525 Vac	T=Aluminum w/steel cover	7 = 7.0 μ F 32 = 32.0 μ F 19.5 = 19.5 μ F	L = \pm 3%	291 = 2.91 391 = 3.91	K = 2-tine with fork and external resistor, 90 °C	Compliant

Type SF Lighting Capacitors, 90 °C Rated

AC Rated, Metallized Polypropylene Capacitors

Oval Case Style

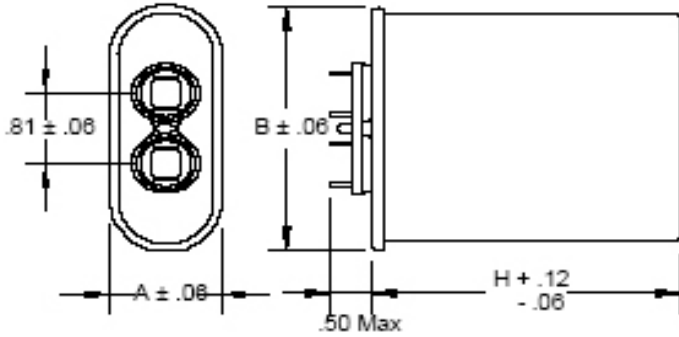

Oval		Dimensions (Inches)		
Case Code	A	B	H	
A	1.31	2.16	See Ratings Table	
B	1.56	2.69	See Ratings Table	
C	1.91	2.91	See Ratings Table	
D	1.97	3.66	See Ratings Table	

Construction Details

Case Material	Aluminum
Encapsulation	Environmentally Safe Dielectric Fluid (Dry construction optional)
Terminal Material	Tin Plated Steel

Oval Ratings

Cap. (μ F)	Case Code	Aluminum Catalog Part Number	H (inches)
280V			
5.0	A	SFA28T5L156K-F	1.56
7.0	A	SFA28T7L156K-F	1.56
10.0	A	SFA28T10L288K-F	2.88
12.0	A	SFA28T12L288K-F	2.88
14.0	A	SFA28T14L288K-F	2.88
17.5	C	SFC28T17.5L291K-F	2.91
20.0	C	SFC28T20L291K-F	2.91
35.0	C	SFC28T35L291K-F	2.91
48.0	C	SFC28T48L391K-F	3.91
55.0	C	SFC28T55L391K-F	3.91
300V			
10.0	A	SFA30T10L288K-F	2.88
12.0	A	SFA30T12L288K-F	2.88
14.0	A	SFA30T14L288K-F	2.88
16.0	C	SFC30T16L291K-F	2.91
20.0	C	SFC30T20L291K-F	2.91
330V			
22.5	C	SFC33T22.5L291K-F	2.91
24.0	C	SFC33T24L291K-F	2.91
26.0	C	SFC33T26L291K-F	2.91
28.0	C	SFC33T28L291K-F	2.91
30.0	C	SFC33T30L291K-F	2.91
400V			
10.0	A	SFA40T10L288K-F	2.88
15.0	C	SFC40T15L291K-F	2.91
19.5	C	SFC40T19.5L291K-F	2.91
20.5	C	SFC40T20.5L291K-F	2.91
24.0	C	SFC40T24L391K-F	3.91
480V			
12.0	C	SFC48T12L291K-F	2.91
15.0	C	SFC48T15L291K-F	2.91
18.0	C	SFC48T18L291K-F	2.91
19.0	C	SFC48T19L291K-F	2.91
21.0	C	SFC48T21L391K-F	3.91
24.0	C	SFC48T24L391K-F	3.91
525V			
16.0	C	SFC52T16L391K-F	3.91
26.0	D	SFD52T26L391K-F	3.91
32.0	D	SFD52T32L391K-F	3.91

Type SF Lighting Capacitors, 90 °C Rated

AC Rated, Metallized Polypropylene Capacitors

Round Case Style

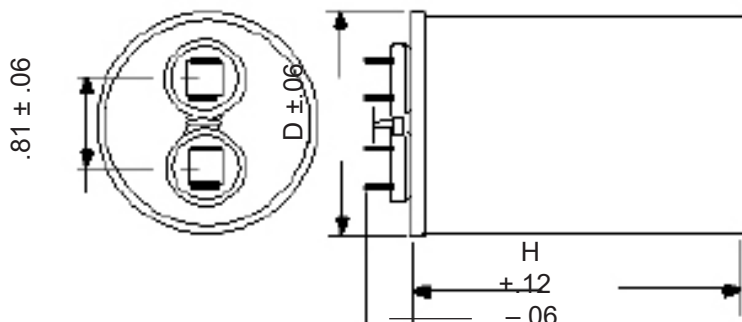

Case Code	D (Inches)	H
P	1.87	See Ratings Table
S	2.12	See Ratings Table
T	2.62	See Ratings Table

Construction Details	
Case Material	Aluminum
Encapsulation	Environmentally Safe Dielectric Fluid (Dry construction optional)
Terminal Material	Tin Plated Steel

Round Ratings

Cap. (μF)	Case Code	Aluminum Catalog Part Number	H (inches)
280V			
5.0	P	SFP28T5L238K-F	2.38
7.0	P	SFP28T7L238K-F	2.38
10.0	P	SFP28T10L238K-F	2.38
12.0	P	SFP28T12L238K-F	2.38
14.0	P	SFP28T14L238K-F	2.38
17.5	P	SFP28T17.5L238K-F	2.38
20.0	P	SFP28T20L284K-F	2.84
35.0	P	SFP28T35L284K-F	2.84
48.0	P	SFP28T48L384K-F	3.84
55.0	S	SFS28T55L384K-F	3.84
300V			
10.0	P	SFP30T10L238K-F	2.38
12.0	P	SFP30T12L238K-F	2.38
14.0	P	SFP30T14L238K-F	2.38
16.0	P	SFP30T16L238K-F	2.38
20.0	P	SFP30T20L238K-F	2.38
330V			
22.5	P	SFP33T22.5L284K-F	2.84
24.0	P	SFP33T24L284K-F	2.84
26.0	P	SFP33T26L284K-F	2.84
28.0	P	SFP33T28L284K-F	2.84
30.0	P	SFP33T30L284K-F	2.84
400V			
10.0	P	SFP40T10L284K-F	2.84
15.0	P	SFP40T15L284K-F	2.84
19.5	P	SFP40T19.5L284K-F	2.84
20.5	P	SFP40T20.5L284K-F	2.84
24.0	P	SFP40T24L384K-F	3.84
480V			
12.0	P	SFP48T12L284K-F	2.84
15.0	P	SFP48T15L284K-F	2.84
18.0	S	SFS48T18L291K-F	2.91
19.0	S	SFS48T19L291K-F	2.91
21.0	S	SFS48T21L291K-F	2.91
24.0	P	SFP48T24L384K-F	3.84
525V			
16.0	S	SFS52T16L291K-F	2.91
26.0	T	SFT52T26L391K-F	3.91
32.0	T	SFT52T32L391K-F	3.91

Notice and Disclaimer: All product drawings, descriptions, specifications, statements, information and data (collectively, the "Information") in this datasheet or other publication are subject to change. The customer is responsible for checking, confirming and verifying the extent to which the Information contained in this datasheet or other publication is applicable to an order at the time the order is placed. All Information given herein is believed to be accurate and reliable, but it is presented without any guarantee, warranty, representation or responsibility of any kind, expressed or implied. Statements of suitability for certain applications are based on the knowledge that the Cornell Dubilier company providing such statements ("Cornell Dubilier") has of operating conditions that such Cornell Dubilier company regards as typical for such applications, but are not intended to constitute any guarantee, warranty or representation regarding any such matter – and Cornell Dubilier specifically and expressly disclaims any guarantee, warranty or representation concerning the suitability for a specific customer application, use, storage, transportation, or operating environment. The Information is intended for use only by customers who have the requisite experience and capability to determine the correct products for their application. Any technical advice inferred from this Information or otherwise provided by Cornell Dubilier with reference to the use of any Cornell Dubilier products is given gratis (unless otherwise specified by Cornell Dubilier), and Cornell Dubilier assumes no obligation or liability for the advice given or results obtained. Although Cornell Dubilier strives to apply the most stringent quality and safety standards regarding the design and manufacturing of its products, in light of the current state of the art, isolated component failures may still occur. Accordingly, customer applications which require a high degree of reliability or safety should employ suitable designs or other safeguards (such as installation of protective circuitry or redundancies or other appropriate protective measures) in order to ensure that the failure of an electrical component does not result in a risk of personal injury or property damage. Although all product-related warnings, cautions and notes must be observed, the customer should not assume that all safety measures are indicated in such warnings, cautions and notes, or that other safety measures may not be required.

Looking for pricing, stock, or lifecycle information?

Click below to explore more details on WIN SOURCE:

- ⊖ [View SFC48S15L291K-F on WIN SOURCE](#)
- ⊖ [Cornell Dubilier Electronics \(CDE\) Information](#)

Optimize Your Supply Chain with WIN SOURCE Solutions

- ✓ Global Sourcing Solution
- ✓ Obsolete Management
- ✓ Cost Control Management
- ✓ Shortage Management
- ✓ Alternative Solution
- ✓ Excess Inventory Management