



**THE DATASHEET OF  
SNU102K104R-F**



# Type SNU Snubber Capacitors

## Oil-Filled, Metallic Case for Snubber Applications



With a robust film/paper/extended foil construction, Type SNU capacitors have low inductance and high peak current ratings that make them ideal for power snubber applications. The Type SNU may be used to reduce voltage transients across semiconductor devices such as SCRs.

### Highlights

- High peak current rating
- Film/paper/extended foil construction
- Internally protected (not UL recognized)
- Aluminum Case (tinplate steel may be substituted for aluminum)

### Specifications

Capacitance Range	0.05 $\mu$ F to 2.0 $\mu$ F
Capacitance Tolerance	$\pm 10\%$
Rated Voltage	1000 Vpk, 2000 Vpk
Operating Temperature Range	-50 $^{\circ}$ C to 70 $^{\circ}$ C
Dissipation Factor	.3% Maximum
Self Inductance	0.10 $\mu$ Hn Maximum
<a href="#">Regulatory Information</a>	

### Outline Drawing

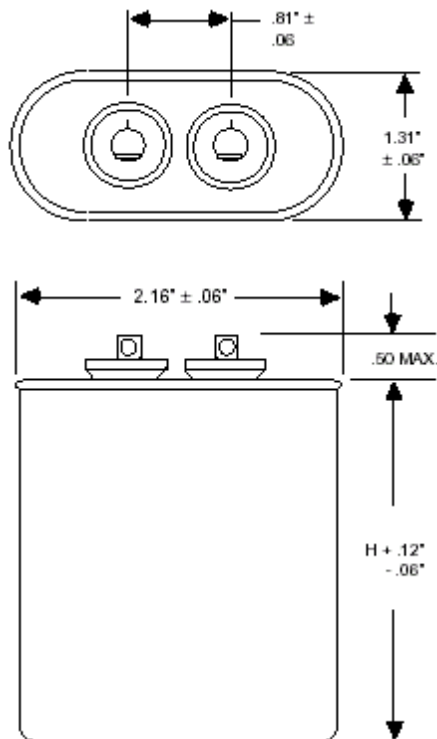

### Ratings

Cap ( $\mu$ F)	Catalog Part Number	Case Code	Height (H) (Inches)	Current @ 55 $^{\circ}$ C (Arms)
<b>1000 Vpk</b>				
0.10	SNU102K104R-F	A	2.13	3
0.25	SNU102K254R-F	A	2.13	4
0.50	SNU102K504R-F	A	2.13	6
1.00	SNU102K105R-F	A	2.13	7
2.00	SNU102K205R-F	A	3.13	11
<b>2000 Vpk</b>				
0.05	SNU202K503R-F	A	2.13	2
0.10	SNU202K104R-F	A	2.13	3
0.25	SNU202K254R-F	A	2.13	4
0.50	SNU202K504R-F	A	2.88	7
1.00	SNU202K105R-F	A	4.50	12



## Type SNU Snubber Capacitors

---

**Notice and Disclaimer:** All product drawings, descriptions, specifications, statements, information and data (collectively, the "Information") in this datasheet or other publication are subject to change. The customer is responsible for checking, confirming and verifying the extent to which the Information contained in this datasheet or other publication is applicable to an order at the time the order is placed. All Information given herein is believed to be accurate and reliable, but it is presented without any guarantee, warranty, representation or responsibility of any kind, expressed or implied. Statements of suitability for certain applications are based on the knowledge that the Cornell Dubilier company providing such statements ("Cornell Dubilier") has of operating conditions that such Cornell Dubilier company regards as typical for such applications, but are not intended to constitute any guarantee, warranty or representation regarding any such matter – and Cornell Dubilier specifically and expressly disclaims any guarantee, warranty or representation concerning the suitability for a specific customer application, use, storage, transportation, or operating environment. The Information is intended for use only by customers who have the requisite experience and capability to determine the correct products for their application. Any technical advice inferred from this Information or otherwise provided by Cornell Dubilier with reference to the use of any Cornell Dubilier products is given gratis (unless otherwise specified by Cornell Dubilier), and Cornell Dubilier assumes no obligation or liability for the advice given or results obtained. Although Cornell Dubilier strives to apply the most stringent quality and safety standards regarding the design and manufacturing of its products, in light of the current state of the art, isolated component failures may still occur. Accordingly, customer applications which require a high degree of reliability or safety should employ suitable designs or other safeguards (such as installation of protective circuitry or redundancies or other appropriate protective measures) in order to ensure that the failure of an electrical component does not result in a risk of personal injury or property damage. Although all product-related warnings, cautions and notes must be observed, the customer should not assume that all safety measures are indicated in such warnings, cautions and notes, or that other safety measures may not be required.

## Looking for pricing, stock, or lifecycle information?

Click below to explore more details on WIN SOURCE:

-  [View SNU102K104R-F on WIN SOURCE](#)
-  [Cornell Dubilier Electronics \(CDE\) Information](#)

## Optimize Your Supply Chain with WIN SOURCE Solutions

-  Global Sourcing Solution
-  Obsolete Management
-  Cost Control Management
-  Shortage Management
-  Alternative Solution
-  Excess Inventory Management