

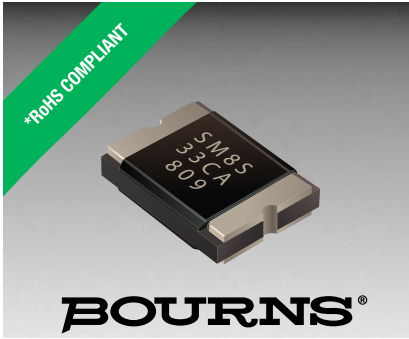

**THE DATASHEET OF
SM8SF28A-Q**





Features

- Maximum Peak Power Dissipation: 7000 watts
- Meets ISO7637-2 / ISO16750-2 Surge specification (varies by test condition)
- RoHS compliant*
- AEC-Q101 compliant** and manufactured at an IATF 16949:2016 certified factory

Applications

- High peak power applications (up to rated limits)
- High temperature applications (up to rated limits)
- Clamping diode
- Load switching and lighting

SM8SF-Q Transient Voltage Suppressor Diode Series

General Information

The Model SM8SF-Q Series TVS diodes are designed to provide overvoltage protection for sensitive electronics, meeting ISO7637-2 and ISO16750-2 requirements (varies by test condition).

The Model SM8SF-Q Series offers a choice of Working Peak Reverse Voltages from 24 V to 36 V and Breakdown Voltage up to 40 V. The SM8SF-Q is available in a compact DFN package of 8.1 mm x 10.5 mm, with a low profile of just 1.3 mm, facilitating layout in today's compact PCB designs.

Additional Information

Click these links for more information:



Absolute Maximum Ratings (@ T_A = 25 °C Unless Otherwise Noted)

Parameter	Symbol	Value	Unit
Maximum Peak Pulse Power Dissipation (10/1000 μs)	P _{PK}	7000	W
Power Dissipation with Infinite Heatsink (T _C = 25 °C)	P _D	5	W
Operating Temperature Range	T _J	-55 to +175	°C
Storage Temperature Range	T _{STG}	-55 to +175	°C

Electrical Characteristics (@ T_A = 25 °C Unless Otherwise Noted)

Unidirectional Device		Bidirectional Device		Breakdown Voltage V _{BR} (Volts)			Working Peak Reverse Voltage	Maximum Reverse Leakage @ V _{RWM}	Maximum Reverse Voltage @ I _{RSM}	Maximum Reverse Surge Current
Part No.	Marking	Part No.	Marking	Min.	Max.	@ I _T (mA)	V _{RWM} (V)	I _R (μA)	V _{RSM} (V)	I _{RSM} (A)
SM8SF24A-Q	24A	SM8SF24CA-Q	24CA	26.7	29.5	5	24	10	38.9	180
SM8SF28A-Q	28A	SM8SF28CA-Q	28CA	31.1	34.4	5	28	10	45.4	154
SM8SF30A-Q	30A	SM8SF30CA-Q	30CA	33.3	36.8	5	30	10	48.4	145
SM8SF33A-Q	33A	SM8SF33CA-Q	33CA	36.7	40.6	5	33	10	53.3	131
SM8SF36A-Q	36A	SM8SF36CA-Q	36CA	40.0	44.2	5	36	10	58.1	120



Asia-Pacific: Tel: +886-2 2562-4117 • Email: asiacus@bourns.com

EMEA: Tel: +36 88 885 877 • Email: eurocus@bourns.com

The Americas: Tel: +1-951 781-5500 • Email: americus@bourns.com

www.bourns.com



WARNING Cancer and Reproductive Harm - www.P65Warnings.ca.gov

*RoHS Directive 2015/863, Mar 31, 2015 and Annex.

**"Q" part number suffix for automotive and other applications requiring appropriate AEC-Q101 compliance. Specifications are subject to change without notice.

Users should verify actual device performance in their specific applications.

The products described herein and this document are subject to specific legal disclaimers as set forth on the last page of this document, and at www.bourns.com/docs/legal/disclaimer.pdf.

SM8SF-Q Transient Voltage Suppressor Diode Series



Performance Graphs

Load Dump Power Characteristics

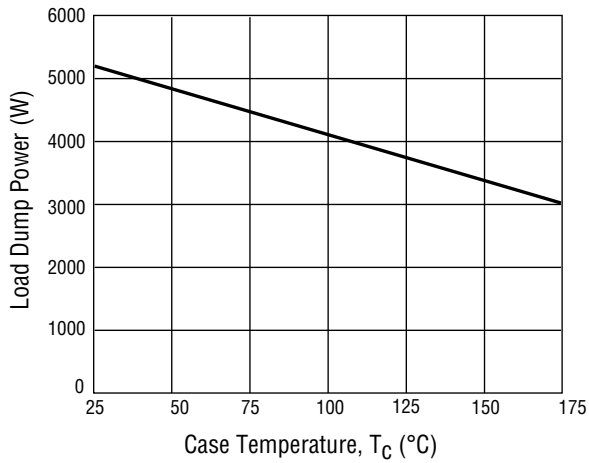

Peak Pulse Power Derating Curve

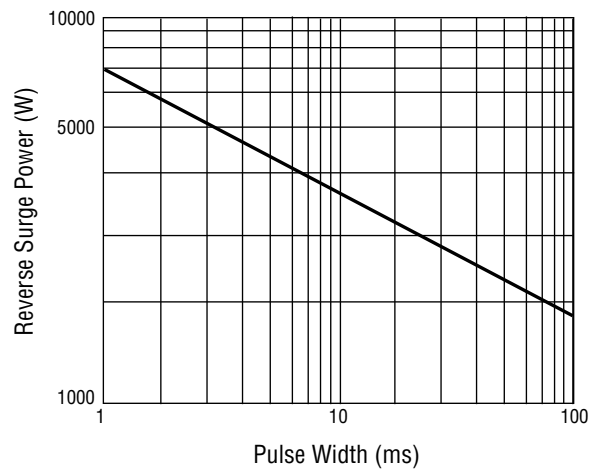

ISO 7637-2: Pulse 5a, Single Pulse: SM8SF-24A-Q

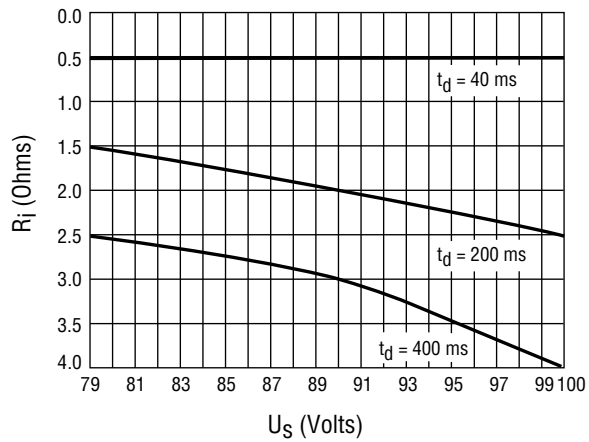

ISO 7637-2: Pulse 5a, Single Pulse: SM8SF-33A-Q

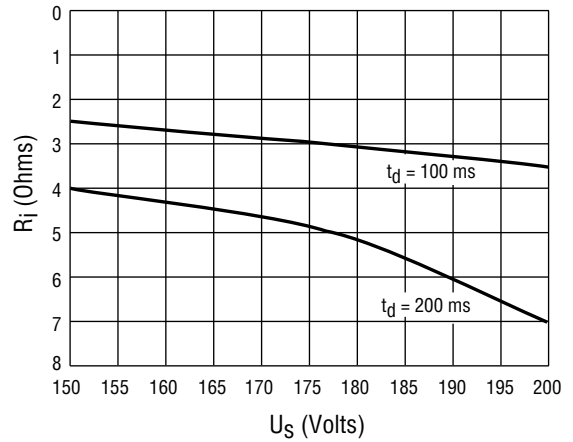

Power Dissipation

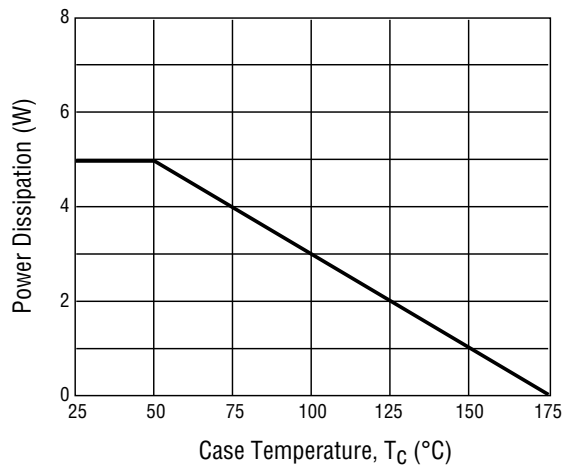

Specifications are subject to change without notice. Users should verify actual device performance in their specific applications. The products described herein and this document are subject to specific legal disclaimers as set forth on the last page of this document, and at www.bourns.com/docs/legal/disclaimer.pdf.

SM8SF-Q Transient Voltage Suppressor Diode Series

BOURNS®

Product Dimensions

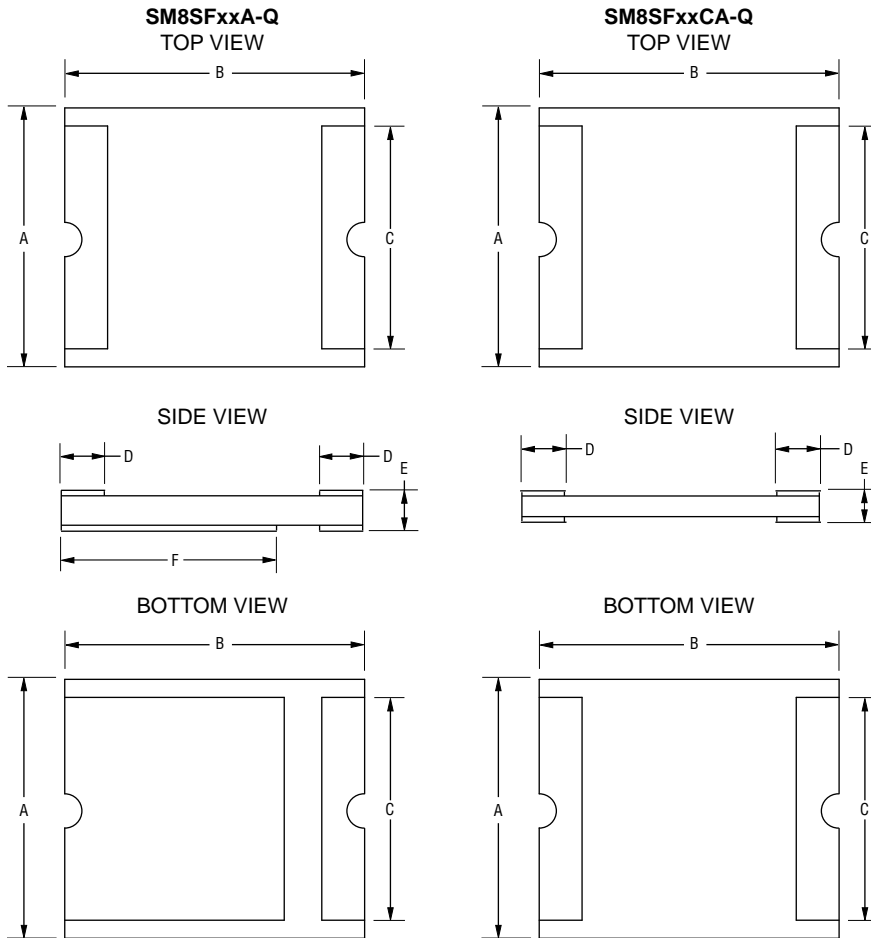

Dimension	Value
A	8.1 ± 0.15 (0.319 ± 0.006)
B	10.5 ± 0.20 (0.413 ± 0.008)
C	7.0 ± 0.15 (0.276 ± 0.006)
D	1.5 ± 0.15 (0.059 ± 0.006)
E	1.3 ± 0.20 (0.051 ± 0.008)
F	7.5 ± 0.15 (0.295 ± 0.006)

DIMENSIONS: $\frac{\text{MM}}{\text{(INCHES)}}$

Recommended Footprint

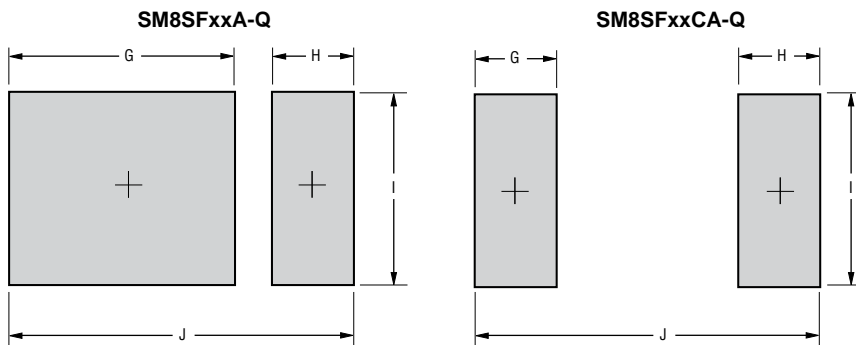

Dim.	SM8SFxxA-Q	SM8SFxxCA-Q
G	9.5	3.5
(Min.)	(0.374)	(0.138)
H	3.5	3.5
(Min.)	(0.138)	(0.138)
I	8.0	8.0
(Min.)	(0.315)	(0.315)
J	14.5	14.5
(Ref.)	(0.571)	(0.571)

DIMENSIONS: $\frac{\text{MM}}{\text{(INCHES)}}$

Specifications are subject to change without notice.

Users should verify actual device performance in their specific applications.

The products described herein and this document are subject to specific legal disclaimers as set forth on the last page of this document, and at www.bourns.com/docs/legal/disclaimer.pdf.

SM8SF-Q Transient Voltage Suppressor Diode Series



Physical Specifications

Case Molded plastic per UL Class 94V-0
 Polarity.....Cathode band indicates unidirectional device
 No cathode band indicates bidirectional device

How to Order

SM8SF 33 CA - Q

Package
 SM8SF = 0.41 inch x 0.32 inch size

Working Peak Reverse Voltage
 33 = 33 V_{RWM} (Volts)

Suffix
 A = 5 % Tolerance Unidirectional Device
 CA = 5 % Tolerance Bidirectional Device

AEC-Q101 Suffix
 Q = AEC-Q101 Compliant

Environmental Specifications

Moisture Sensitivity Level 1
 ESD Classification (HBM).....3B

Typical Part Marking

SM8SFxxA-Q

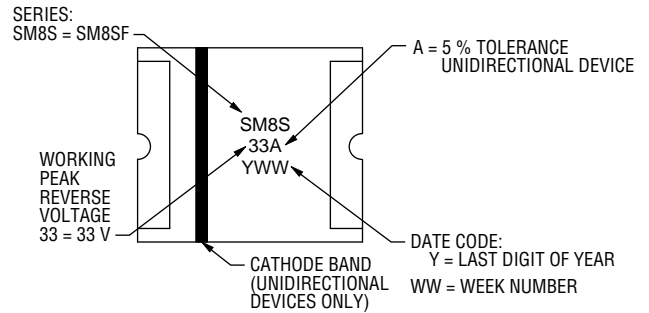

SM8SFxxCA-Q

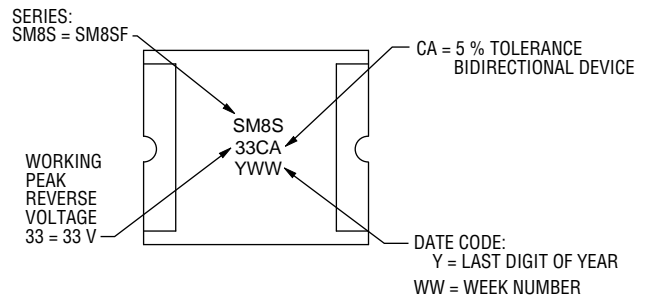

Specifications are subject to change without notice.

Users should verify actual device performance in their specific applications.

The products described herein and this document are subject to specific legal disclaimers as set forth on the last page of this document, and at www.bourns.com/docs/legal/disclaimer.pdf.

SM8SF-Q Transient Voltage Suppressor Diode Series

BOURNS®

Packaging Information

The product will be dispensed in tape and reel format (see diagram below).

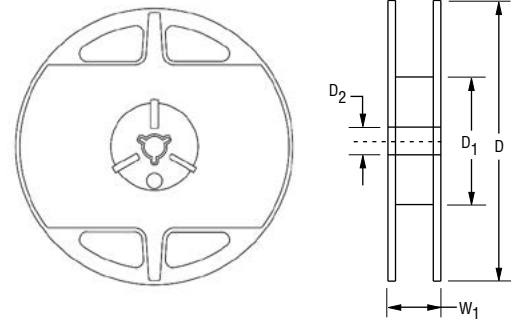
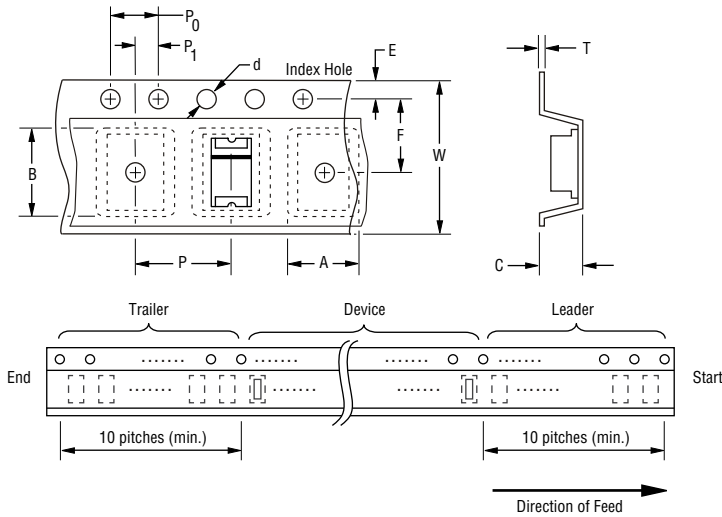

DIMENSIONS: $\frac{\text{MM}}{\text{(INCHES)}}$

Devices are packed in accordance with EIA 481 standard specifications shown here.

Item	Symbol	SM8SF Series
Carrier Width	A	$\frac{8.35 \pm 0.10}{(0.329 \pm 0.004)}$
Carrier Length	B	$\frac{10.75 \pm 0.10}{(0.423 \pm 0.004)}$
Carrier Depth	C	$\frac{1.65 \pm 0.10}{(0.065 \pm 0.004)}$
Sprocket Hole	d	$\frac{1.55 \pm 0.05}{(0.061 \pm 0.002)}$
Reel Outside Diameter	D	$\frac{178 \pm 1.0}{(7.008 \pm 0.039)}$
Reel Inner Diameter	D ₁	$\frac{60 \pm 1.0}{(2.362 \pm 0.039)}$
Feed Hole Diameter	D ₂	$\frac{13.5 \pm 0.50}{(0.531 \pm 0.02)}$
Sprocket Hole Position	E	$\frac{1.75 \pm 0.10}{(0.069 \pm 0.004)}$
Punch Hole Position	F	$\frac{5.50 \pm 0.10}{(0.217 \pm 0.004)}$
Punch Hole Pitch	P	$\frac{12.00 \pm 0.10}{(0.472 \pm 0.004)}$
Sprocket Hole Pitch	P ₀	$\frac{4.00 \pm 0.10}{(0.157 \pm 0.004)}$
Embossment Center	P ₁	$\frac{2.00 \pm 0.10}{(0.079 \pm 0.004)}$
Overall Tape Thickness	T	$\frac{0.40}{(0.016)} \text{ MAX.}$
Tape Width	W	$\frac{16.00 \pm 0.30}{(0.630 \pm 0.012)}$
Reel Width	W ₁	$\frac{18.1 \pm 1.2}{(0.713 \pm 0.047)}$
Quantity per Reel	--	750

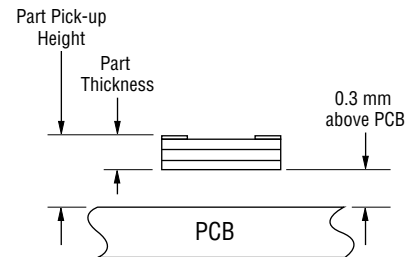

Recommended pick-up height: The bottom of the device should be 0.3 mm above the PCB.

This legal disclaimer applies to purchasers and users of Bourns® products manufactured by or on behalf of Bourns, Inc. and its affiliates (collectively, “Bourns”).

Unless otherwise expressly indicated in writing, Bourns® products and data sheets relating thereto are subject to change without notice. Users should check for and obtain the latest relevant information and verify that such information is current and complete before placing orders for Bourns® products.

The characteristics and parameters of a Bourns® product set forth in its data sheet are based on laboratory conditions, and statements regarding the suitability of products for certain types of applications are based on Bourns’ knowledge of typical requirements in generic applications. The characteristics and parameters of a Bourns® product in a user application may vary from the data sheet characteristics and parameters due to (i) the combination of the Bourns® product with other components in the user’s application, or (ii) the environment of the user application itself. The characteristics and parameters of a Bourns® product also can and do vary in different applications and actual performance may vary over time. Users should always verify the actual performance of the Bourns® product in their specific devices and applications, and make their own independent judgments regarding the amount of additional test margin to design into their device or application to compensate for differences between laboratory and real world conditions.

Unless Bourns has explicitly designated an individual Bourns® product as meeting the requirements of a particular industry standard (e.g., ISO/TS 16949) or a particular qualification (e.g., UL listed or recognized), Bourns is not responsible for any failure of an individual Bourns® product to meet the requirements of such industry standard or particular qualification. Users of Bourns® products are responsible for ensuring compliance with safety-related requirements and standards applicable to their devices or applications.

Bourns® products are not recommended, authorized or intended for use in nuclear, lifesaving, life-critical or life-sustaining applications, nor in any other applications where failure or malfunction may result in personal injury, death, or severe property or environmental damage. Unless expressly and specifically approved in writing by two authorized Bourns representatives on a case-by-case basis, use of any Bourns® products in such unauthorized applications might not be safe and thus is at the user’s sole risk. Life-critical applications include devices identified by the U.S. Food and Drug Administration as Class III devices and generally equivalent classifications outside of the United States.

Bourns expressly identifies those Bourns® standard products that are suitable for use in automotive applications on such products’ data sheets in the section entitled “Applications.” Unless expressly and specifically approved in writing by two authorized Bourns representatives on a case-by-case basis, use of any other Bourns® standard products in an automotive application might not be safe and thus is not recommended, authorized or intended and is at the user’s sole risk. If Bourns expressly identifies a sub-category of automotive application in the data sheet for its standard products (such as infotainment or lighting), such identification means that Bourns has reviewed its standard product and has determined that if such Bourns® standard product is considered for potential use in automotive applications, it should only be used in such sub-category of automotive applications. Any reference to Bourns® standard product in the data sheet as compliant with the AEC-Q standard or “automotive grade” does not by itself mean that Bourns has approved such product for use in an automotive application.

Bourns® standard products are not tested to comply with United States Federal Aviation Administration standards generally or any other generally equivalent governmental organization standard applicable to products designed or manufactured for use in aircraft or space applications. Bourns expressly identifies Bourns® standard products that are suitable for use in aircraft or space applications on such products’ data sheets in the section entitled “Applications.” Unless expressly and specifically approved in writing by two authorized Bourns representatives on a case-by-case basis, use of any other Bourns® standard product in an aircraft or space application might not be safe and thus is not recommended, authorized or intended and is at the user’s sole risk.

The use and level of testing applicable to Bourns® custom products shall be negotiated on a case-by-case basis by Bourns and the user for which such Bourns® custom products are specially designed. Absent a written agreement between Bourns and the user regarding the use and level of such testing, the above provisions applicable to Bourns® standard products shall also apply to such Bourns® custom products.

Users shall not sell, transfer, export or re-export any Bourns® products or technology for use in activities which involve the design, development, production, use or stockpiling of nuclear, chemical or biological weapons or missiles, nor shall they use Bourns® products or technology in any facility which engages in activities relating to such devices. The foregoing restrictions apply to all uses and applications that violate national or international prohibitions, including embargos or international regulations. Further, Bourns® products and Bourns technology and technical data may not under any circumstance be exported or re-exported to countries subject to international sanctions or embargoes. Bourns® products may not, without prior authorization from Bourns and/or the U.S. Government, be resold, transferred, or re-exported to any party not eligible to receive U.S. commodities, software, and technical data.

To the maximum extent permitted by applicable law, Bourns disclaims (i) any and all liability for special, punitive, consequential, incidental or indirect damages or lost revenues or lost profits, and (ii) any and all implied warranties, including implied warranties of fitness for particular purpose, non-infringement and merchantability.

For your convenience, copies of this Legal Disclaimer Notice with German, Spanish, Japanese, Traditional Chinese and Simplified Chinese bilingual versions are available at:

Web Page: <http://www.bourns.com/legal/disclaimers-terms-and-policies>

PDF: <http://www.bourns.com/docs/Legal/disclaimer.pdf>

Looking for pricing, stock, or lifecycle information?

Click below to explore more details on WIN SOURCE:

 [View SM8SF28A-Q on WIN SOURCE](#)

 [Bourns Inc. Information](#)

Optimize Your Supply Chain with WIN SOURCE Solutions

-  Global Sourcing Solution
-  Obsolete Management
-  Cost Control Management
-  Shortage Management
-  Alternative Solution
-  Excess Inventory Management