



**THE DATASHEET OF
SMCJ14CA-Q**





Features

- Surface Mount SMC package
- Standoff Voltage: 5 to 120 volts
- Power Dissipation: 1500 watts
- RoHS compliant*
- AEC-Q101 compliant**

Applications

- Protection of power buses
- Protection of I/O interfaces
- Overvoltage transient protection
- Entertainment applications
- Comfort applications
- Telecom, computer, industrial and consumer electronics applications

SMCJ-Q Transient Voltage Suppressor Diode Series

General Information

Bourns offers Transient Voltage Suppressor Diodes for surge and ESD protection applications, in compact chip package DO-214AB (SMC) size format. The Transient Voltage Suppressor series offers a choice of Working Peak Reverse Voltage from 5 V up to 120 V. Typical fast response times are less than 1.0 picosecond from 0 V to Breakdown Voltage.

Bourns® Chip Diodes conform to JEDEC standards, are easy to handle with standard pick and place equipment and their flat configuration minimizes roll away.

Additional Information

Click these links for more information:



[PRODUCT SELECTOR](#) [TECHNICAL LIBRARY](#) [INVENTORY](#) [SAMPLES](#) [CONTACT](#)

Agency Recognition

Description	
UL	File Number: E153537

Electrical Characteristics (@ T_A = 25 °C Unless Otherwise Noted)

Parameter	Symbol	Value	Unit
Minimum Peak Pulse Power Dissipation (T _P = 1 ms) (Note 1,2)	P _{PK}	1500	Watts
Peak Forward Surge Current 8.3 ms Single Half Sine Wave Superimposed on Rated Load (JEDEC Method) (Note 3)	I _{FSM}	200	Amps
Operating Temperature Range	T _J	-55 to +150	°C
Storage Temperature Range	T _{STG}	-55 to +150	°C

1. Non-repetitive current pulse, per Pulse Waveform graph and derated above T_A = 25 °C per Pulse Derating Curve.
2. Mounted on 5.0 mm² (0.03 mm thick) copper pads to each terminal.
3. 8.3 ms Single Half-Sine Wave duty cycle = 4 pulses maximum per minute (unidirectional units only).

BOURNS®

Asia-Pacific: Tel: +886-2 2562-4117 • Email: asiacus@bourns.com

EMEA: Tel: +36 88 885 877 • Email: eurocus@bourns.com

The Americas: Tel: +1-951 781-5500 • Email: americus@bourns.com

www.bourns.com



WARNING Cancer and Reproductive Harm - www.P65Warnings.ca.gov

* RoHS Directive 2015/863, Mar 31, 2015 and Annex.

**Q* part number suffix for automotive and other applications requiring appropriate AEC-Q101 compliance.

Specifications are subject to change without notice.

Users should verify actual device performance in their specific applications.

The products described herein and this document are subject to specific legal disclaimers as set forth on the last page of this document, and at www.bourns.com/docs/legal/disclaimer.pdf.

SMCJ-Q Transient Voltage Suppressor Diode Series

BOURNS®

Electrical Characteristics (@ T_A = 25 °C Unless Otherwise Noted)

Unidirectional Device		Bidirectional Device		Breakdown Voltage V _{BR} (Volts)			Working Peak Reverse Voltage	Maximum Reverse Leakage @ V _{RWM}	Maximum Clamping Voltage @ I _{pp} (10/1000 μs)	Maximum Peak Pulse Current (10/1000 μs)	Maximum Clamping Voltage @ I _{pp} (8/20 μs)	Maximum Peak Pulse Current (8/20 μs)
Part No.	Marking	Part No.	Marking	Min.	Max.	@ I _T (mA)	V _{RWM} (V)	I _R (μA)	V _C (V)	I _{pp} (A)	V _C (V)	I _{pp} (A)
SMCJ5.0A-Q	GDEQ	SMCJ5.0CA-Q	BDEQ	6.40	7.00	10	5	800	9.2	163	12.0	815.0
SMCJ6.0A-Q	GDGQ	SMCJ6.0CA-Q	BDGQ	6.67	7.37	10	6	800	10.3	145.7	13.4	728.5
SMCJ6.5A-Q	GDKQ	SMCJ6.5CA-Q	BDKQ	7.22	7.98	10	6.5	500	11.2	134	15.0	670.0
SMCJ7.0A-Q	GDMQ	SMCJ7.0CA-Q	BDMQ	7.78	8.60	10	7	200	12	125	16.0	625.0
SMCJ7.5A-Q	GDPQ	SMCJ7.5CA-Q	BDPQ	8.33	9.21	1	7.5	100	12.9	116.3	16.8	581.5
SMCJ8.0A-Q	GDRQ	SMCJ8.0CA-Q	BDRQ	8.89	9.83	1	8	50	13.6	110.3	17.7	551.5
SMCJ8.5A-Q	GDTQ	SMCJ8.5CA-Q	BDTQ	9.44	10.4	1	8.5	20	14.4	104.2	18.7	521.0
SMCJ9.0A-Q	GDVQ	SMCJ9.0CA-Q	BDVQ	10.0	11.1	1	9	10	15.4	97.4	20.0	487.0
SMCJ10A-Q	GDXQ	SMCJ10CA-Q	BDXQ	11.1	12.3	1	10	5	17	88.3	22.1	441.5
SMCJ11A-Q	GDZQ	SMCJ11CA-Q	BDZQ	12.2	13.5	1	11	1	18.2	82.5	23.7	412.5
SMCJ12A-Q	GEEQ	SMCJ12CA-Q	BEEQ	13.3	14.7	1	12	1	19.9	75.4	25.9	377.0
SMCJ13A-Q	GEGQ	SMCJ13CA-Q	BEGQ	14.4	15.9	1	13	1	21.5	69.8	28.0	349.0
SMCJ14A-Q	GEKQ	SMCJ14CA-Q	BEKQ	15.6	17.2	1	14	1	23.2	64.7	30.2	323.5
SMCJ15A-Q	GEMQ	SMCJ15CA-Q	BEMQ	16.7	18.5	1	15	1	24.4	61.5	31.7	307.5
SMCJ16A-Q	GEPQ	SMCJ16CA-Q	BEPQ	17.8	19.7	1	16	1	26	57.7	33.8	288.5
SMCJ17A-Q	GERQ	SMCJ17CA-Q	BERQ	18.9	20.9	1	17	1	27.6	54.4	35.9	272.0
SMCJ18A-Q	GETQ	SMCJ18CA-Q	BETQ	20.0	22.1	1	18	1	29.2	51.4	38.0	257.0
SMCJ20A-Q	GEVQ	SMCJ20CA-Q	BEVQ	22.2	24.5	1	20	1	32.4	46.3	42.1	231.5
SMCJ22A-Q	GEXQ	SMCJ22CA-Q	BEXQ	24.4	26.9	1	22	1	35.5	42.3	46.2	211.5
SMCJ24A-Q	GEZQ	SMCJ24CA-Q	BEZQ	26.7	29.5	1	24	1	38.9	38.6	50.6	193.0
SMCJ26A-Q	GFEQ	SMCJ26CA-Q	BFEQ	28.9	31.9	1	26	1	42.1	35.7	54.7	178.5
SMCJ28A-Q	GFGQ	SMCJ28CA-Q	BFGQ	31.1	34.4	1	28	1	45.4	33.1	59.0	165.5
SMCJ30A-Q	GFKQ	SMCJ30CA-Q	BFKQ	33.3	36.8	1	30	1	48.4	31	63	155
SMCJ33A-Q	GFMQ	SMCJ33CA-Q	BFMQ	36.7	40.6	1	33	1	53.3	28.1	69.3	141.0
SMCJ36A-Q	GFPQ	SMCJ36CA-Q	BFPQ	40	44.2	1	36	1	58.1	25.9	75.5	129.5
SMCJ40A-Q	GFRQ	SMCJ40CA-Q	BFRQ	44.4	49.1	1	40	1	64.5	23.3	83.9	116.5
SMCJ43A-Q	GFTQ	SMCJ43CA-Q	BFTQ	47.8	52.8	1	43	1	69.4	21.7	90.2	108.5
SMCJ45A-Q	GFVQ	SMCJ45CA-Q	BFVQ	50	55.3	1	45	1	72.7	20.6	94.5	103.0
SMCJ48A-Q	GFXQ	SMCJ48CA-Q	BFXQ	53.3	58.9	1	48	1	77.4	19.4	100.6	97.0
SMCJ51A-Q	GFZQ	SMCJ51CA-Q	BFZQ	56.7	62.7	1	51	1	82.4	18.2	107.1	91.0
SMCJ54A-Q	GGEQ	SMCJ54CA-Q	BGEQ	60	66.3	1	54	1	87.1	17.3	113.2	86.5
SMCJ58A-Q	GGGQ	SMCJ58CA-Q	BGGQ	64.4	71.2	1	58	1	93.6	16.1	121.7	80.5
SMCJ60A-Q	GGKQ	SMCJ60CA-Q	BGKQ	66.7	73.7	1	60	1	96.8	15.5	125.8	77.5
SMCJ64A-Q	GGMQ	SMCJ64CA-Q	BGMQ	71.1	78.6	1	64	1	103	14.6	133.9	73.0
SMCJ70A-Q	GGPQ	SMCJ70CA-Q	BGPQ	77.8	86.0	1	70	1	113	13.3	146.9	66.5
SMCJ75A-Q	GGRQ	SMCJ75CA-Q	BGRQ	83.3	92.1	1	75	1	121	12.4	157.3	62.0
SMCJ78A-Q	GGTQ	SMCJ78CA-Q	BGTQ	86.7	95.8	1	78	1	126	11.9	163.8	59.5
SMCJ85A-Q	GGVQ	SMCJ85CA-Q	BGVQ	94.4	104	1	85	1	137	11	178	55
SMCJ90A-Q	GGXQ	SMCJ90CA-Q	BGXQ	100	111	1	90	1	146	10.3	189.8	51.5
SMCJ100A-Q	GGZQ	SMCJ100CA-Q	BGZQ	111	123	1	100	1	162	9.3	210.6	46.5
SMCJ110A-Q	GHEQ	SMCJ110CA-Q	BHEQ	122	135	1	110	1	177	8.4	230.1	42.5
SMCJ120A-Q	GHGQ	SMCJ120CA-Q	BHGQ	133	147	1	120	1	193	7.9	250.9	39.0

Notes:

- Suffix 'A' denotes a 5 % tolerance unidirectional device.
- Suffix 'CA' denotes a 5 % tolerance bidirectional device.

Specifications are subject to change without notice.

Users should verify actual device performance in their specific applications.

The products described herein and this document are subject to specific legal disclaimers as set forth on the last page of this document, and at www.bourns.com/docs/legal/disclaimer.pdf.

NEW!

NEW!

SMCJ-Q Transient Voltage Suppressor Diode Series

BOURNS®

Performance Graphs

Peak Pulse Power Derating Curve



Maximum Non-Repetitive Surge Current



Pulse Waveform

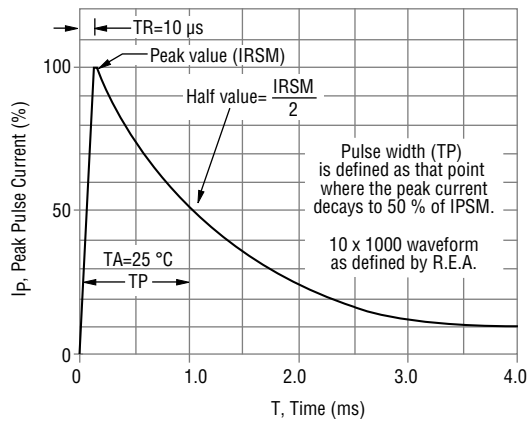

Typical Junction Capacitance



Pulse Rating Curve



Steady State Power Derating Curve



Specifications are subject to change without notice.

Users should verify actual device performance in their specific applications.

The products described herein and this document are subject to specific legal disclaimers as set forth on the last page of this document, and at www.bourns.com/docs/legal/disclaimer.pdf.

SMCJ-Q Transient Voltage Suppressor Diode Series



Product Dimensions



Dimension	SMC (DO-214AB)
A	$\frac{6.60 - 7.11}{(0.260 - 0.280)}$
B	$\frac{5.59 - 6.22}{(0.220 - 0.245)}$
C	$\frac{2.90 - 3.20}{(0.115 - 0.125)}$
D	$\frac{0.15 - 0.31}{(0.006 - 0.012)}$
E	$\frac{7.75 - 8.13}{(0.305 - 0.320)}$
F	$\frac{0.203}{(0.008)}$ MAX.
G	$\frac{2.00 - 2.62}{(0.079 - 0.103)}$
H	$\frac{0.76 - 1.52}{(0.030 - 0.060)}$

DIMENSIONS: $\frac{\text{MM}}{\text{(INCHES)}}$

Typical Part Marking



Recommended Footprint



Dimension	SMC (DO-214AB)
A (Max.)	$\frac{4.69}{(0.185)}$
B (Min.)	$\frac{3.07}{(0.121)}$
C (Min.)	$\frac{1.52}{(0.060)}$

DIMENSIONS: $\frac{\text{MM}}{\text{(INCHES)}}$

Physical Specifications

Case Molded plastic per UL Class 94V-0
 Polarity.....Cathode band indicates unidirectional device
 No cathode band indicates bidirectional device

How to Order

Package SMCJ 5 CA - Q
 SMCJ-Q = SMC/DO-214AB
 Working Peak Reverse Voltage 5 ~ 120 = 5 ~ 120 V_{RWM} (Volts)
 Suffix A = 5 % Tolerance Unidirectional Device
CA = 5 % Tolerance Bidirectional Device
 AEC-Q101 Suffix Q = AEC-Q101 Compliant, 13-inch Reel
QH = AEC-Q101 Compliant, 7-inch Reel

Environmental Specifications

Moisture Sensitivity Level 1
 ESD Classification (HBM).....3B

SMCJ-Q Transient Voltage Suppressor Diode Series

BOURNS®

Packaging Information

The product will be dispensed in tape and reel format (see diagram below).

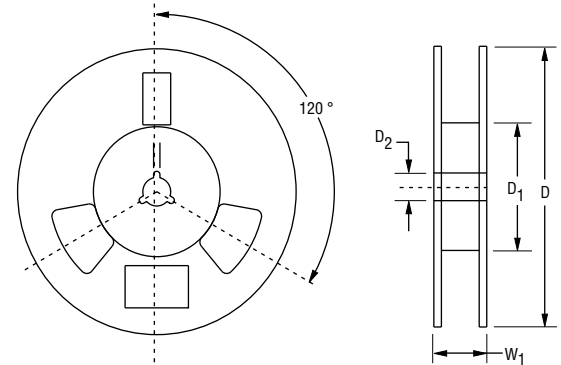

DIMENSIONS: $\frac{\text{MM}}{\text{(INCHES)}}$

Devices are packed in accordance with EIA standard RS-481-A and specifications shown here.

Item	Symbol	SMC (DO-214AB)	
		7-Inch Reel	13-Inch Reel
Carrier Width	A	$\frac{6.0 \pm 2.0}{(0.236 - 0.079)}$	
Carrier Length	B	$\frac{8.3 \pm 0.20}{(0.327 \pm 0.008)}$	
Carrier Depth	C	$\frac{2.5 \pm 0.20}{(0.098 \pm 0.008)}$	
Sprocket Hole	d	$\frac{1.50 \pm 0.10}{(0.059 \pm 0.004)}$	
Reel Outside Diameter	D	$\frac{178}{(7.008)}$	$\frac{330}{(12.992)}$
Reel Inner Diameter	D ₁	$\frac{50.0}{(1.969)} \text{ MIN.}$	
Feed Hole Diameter	D ₂	$\frac{13.0 + 0.50/-0.20}{(0.512 + 0.020/-0.008)}$	
Sprocket Hole Position	E	$\frac{1.75 \pm 0.10}{(0.069 \pm 0.004)}$	
Punch Hole Position	F	$\frac{7.50 \pm 0.10}{(0.295 \pm 0.004)}$	
Punch Hole Pitch	P	$\frac{8.00 \pm 0.10}{(0.315 \pm 0.004)}$	
Sprocket Hole Pitch	P ₀	$\frac{4.00 \pm 0.10}{(0.157 \pm 0.004)}$	
Embossment Center	P ₁	$\frac{2.00 \pm 0.10}{(0.079 \pm 0.004)}$	
Overall Tape Thickness	T	$\frac{0.30 \pm 0.10}{(0.012 \pm 0.004)}$	
Tape Width	W	$\frac{16.00 \pm 0.30}{(0.630 \pm 0.012)}$	
Reel Width	W ₁	$\frac{22.4}{(0.882)} \text{ MAX.}$	
Quantity per Reel	--	500	3000

REV. 07/21

Specifications are subject to change without notice.

Users should verify actual device performance in their specific applications.

The products described herein and this document are subject to specific legal disclaimers as set forth on the last page of this document, and at www.bourns.com/docs/legal/disclaimer.pdf.

This legal disclaimer applies to purchasers and users of Bourns® products manufactured by or on behalf of Bourns, Inc. and its affiliates (collectively, “Bourns”).

Unless otherwise expressly indicated in writing, Bourns® products and data sheets relating thereto are subject to change without notice. Users should check for and obtain the latest relevant information and verify that such information is current and complete before placing orders for Bourns® products.

The characteristics and parameters of a Bourns® product set forth in its data sheet are based on laboratory conditions, and statements regarding the suitability of products for certain types of applications are based on Bourns’ knowledge of typical requirements in generic applications. The characteristics and parameters of a Bourns® product in a user application may vary from the data sheet characteristics and parameters due to (i) the combination of the Bourns® product with other components in the user’s application, or (ii) the environment of the user application itself. The characteristics and parameters of a Bourns® product also can and do vary in different applications and actual performance may vary over time. Users should always verify the actual performance of the Bourns® product in their specific devices and applications, and make their own independent judgments regarding the amount of additional test margin to design into their device or application to compensate for differences between laboratory and real world conditions.

Unless Bourns has explicitly designated an individual Bourns® product as meeting the requirements of a particular industry standard (e.g., ISO/TS 16949) or a particular qualification (e.g., UL listed or recognized), Bourns is not responsible for any failure of an individual Bourns® product to meet the requirements of such industry standard or particular qualification. Users of Bourns® products are responsible for ensuring compliance with safety-related requirements and standards applicable to their devices or applications.

Bourns® products are not recommended, authorized or intended for use in nuclear, lifesaving, life-critical or life-sustaining applications, nor in any other applications where failure or malfunction may result in personal injury, death, or severe property or environmental damage. Unless expressly and specifically approved in writing by two authorized Bourns representatives on a case-by-case basis, use of any Bourns® products in such unauthorized applications might not be safe and thus is at the user’s sole risk. Life-critical applications include devices identified by the U.S. Food and Drug Administration as Class III devices and generally equivalent classifications outside of the United States.

Bourns expressly identifies those Bourns® standard products that are suitable for use in automotive applications on such products’ data sheets in the section entitled “Applications.” Unless expressly and specifically approved in writing by two authorized Bourns representatives on a case-by-case basis, use of any other Bourns® standard products in an automotive application might not be safe and thus is not recommended, authorized or intended and is at the user’s sole risk. If Bourns expressly identifies a sub-category of automotive application in the data sheet for its standard products (such as infotainment or lighting), such identification means that Bourns has reviewed its standard product and has determined that if such Bourns® standard product is considered for potential use in automotive applications, it should only be used in such sub-category of automotive applications. Any reference to Bourns® standard product in the data sheet as compliant with the AEC-Q standard or “automotive grade” does not by itself mean that Bourns has approved such product for use in an automotive application.

Bourns® standard products are not tested to comply with United States Federal Aviation Administration standards generally or any other generally equivalent governmental organization standard applicable to products designed or manufactured for use in aircraft or space applications. Bourns expressly identifies Bourns® standard products that are suitable for use in aircraft or space applications on such products’ data sheets in the section entitled “Applications.” Unless expressly and specifically approved in writing by two authorized Bourns representatives on a case-by-case basis, use of any other Bourns® standard product in an aircraft or space application might not be safe and thus is not recommended, authorized or intended and is at the user’s sole risk.

The use and level of testing applicable to Bourns® custom products shall be negotiated on a case-by-case basis by Bourns and the user for which such Bourns® custom products are specially designed. Absent a written agreement between Bourns and the user regarding the use and level of such testing, the above provisions applicable to Bourns® standard products shall also apply to such Bourns® custom products.

Users shall not sell, transfer, export or re-export any Bourns® products or technology for use in activities which involve the design, development, production, use or stockpiling of nuclear, chemical or biological weapons or missiles, nor shall they use Bourns® products or technology in any facility which engages in activities relating to such devices. The foregoing restrictions apply to all uses and applications that violate national or international prohibitions, including embargos or international regulations. Further, Bourns® products and Bourns technology and technical data may not under any circumstance be exported or re-exported to countries subject to international sanctions or embargoes. Bourns® products may not, without prior authorization from Bourns and/or the U.S. Government, be resold, transferred, or re-exported to any party not eligible to receive U.S. commodities, software, and technical data.

To the maximum extent permitted by applicable law, Bourns disclaims (i) any and all liability for special, punitive, consequential, incidental or indirect damages or lost revenues or lost profits, and (ii) any and all implied warranties, including implied warranties of fitness for particular purpose, non-infringement and merchantability.

For your convenience, copies of this Legal Disclaimer Notice with German, Spanish, Japanese, Traditional Chinese and Simplified Chinese bilingual versions are available at:

Web Page: <http://www.bourns.com/legal/disclaimers-terms-and-policies>

PDF: <http://www.bourns.com/docs/Legal/disclaimer.pdf>

Looking for pricing, stock, or lifecycle information?

Click below to explore more details on WIN SOURCE:

- ⊖ [View SMCJ14CA-Q on WIN SOURCE](#)
- ⊖ [Bourns Inc. Information](#)

Optimize Your Supply Chain with WIN SOURCE Solutions

- ✓ Global Sourcing Solution
- ✓ Obsolete Management
- ✓ Cost Control Management
- ✓ Shortage Management
- ✓ Alternative Solution
- ✓ Excess Inventory Management