



**THE DATASHEET OF
SMBJ400A-H**





Features

- RoHS compliant*
- Surface Mount SMB package
- Standoff Voltage: 5 to 495 volts
- Power Dissipation: 600 watts

Applications

- IEC 61000-4-2 ESD (Min. Level 4)
- IEC 61000-4-4 EFT
- IEC 61000-4-5 Surge

SMBJ Transient Voltage Suppressor Diode Series

General Information

The markets of portable communications, computing and video equipment are challenging the semiconductor industry to develop increasingly smaller electronic components.

Bourns offers Transient Voltage Suppressor Diodes for surge and ESD protection applications, in compact chip package DO-214AA (SMB) size format. The Transient Voltage Suppressor series offers a choice of Working Peak Reverse Voltage from 5 V up to 495 V and Breakdown Voltage up to 550 V. Typical fast response times are less than 1.0 picosecond for unidirectional devices and less than 5.0 picoseconds for bidirectional devices from 0 V to Minimum Breakdown Voltage.

Bourns® Chip Diodes conform to JEDEC standards, are easy to handle with standard pick and place equipment and the flat configuration minimizes roll away.

Additional Information

Click these links for more information:



[PRODUCT SELECTOR](#) [TECHNICAL LIBRARY](#) [INVENTORY](#) [SAMPLES](#) [CONTACT](#)

Agency Recognition

Description	
UL	File Number: E153537

Electrical Characteristics (@ T_A = 25 °C Unless Otherwise Noted)

Parameter	Symbol	Value	Unit
Minimum Peak Pulse Power Dissipation (T _P = 1 ms) (Note 1,2)	P _{PK}	600	Watts
Peak Forward Surge Current 8.3 ms Single Half Sine Wave Superimposed on Rated Load (JEDEC Method) (Note 3)	I _{FSM}	100	Amps
Steady State Power Dissipation @ T _L = 75 °C	P _{M(AV)}	5.0	Watts
Maximum Instantaneous Forward Voltage @ I _{PP} = 50 A (For Unidirectional Units Only)	V _F	3.5 5.0	Volts
Operating Temperature Range	T _J	-55 to +150	°C
Storage Temperature Range	T _{STG}	-55 to +150	°C

1. Non-repetitive current pulse, per Pulse Waveform graph and derated above T_A = 25 °C per Pulse Derating Curve.
2. Thermal Resistance Junction to Lead.
3. 8.3 ms Single Half-Sine Wave duty cycle = 4 pulses maximum per minute (unidirectional units only).

BOURNS®

Asia-Pacific:

Tel: +886-2 2562-4117 • Email: asiacus@bourns.com

EMEA:

Tel: +36 88 885 877 • Email: eurocus@bourns.com

The Americas:

Tel: +1-951 781-5500 • Email: americus@bourns.com

www.bourns.com

How to Order

Package	SMBJ	5.0	CA - H
SMBJ = SMB/DO-214AA			
Working Peak Reverse Voltage	5.0 = 5.0 V _{RWM} (Volts)		
Suffix	A = 5 % Tolerance Unidirectional Device		
	CA = 5 % Tolerance Bidirectional Device		
Reel	(blank) = 13 inch reel		
	-H = 7 inch reel		



WARNING Cancer and Reproductive Harm - www.P65Warnings.ca.gov

*RoHS Directive 2015/863, Mar 31, 2015 and Annex.

Specifications are subject to change without notice.

Users should verify actual device performance in their specific applications.

The products described herein and this document are subject to specific legal disclaimers as set forth on the last page of this document, and at www.bourns.com/docs/legal/disclaimer.pdf.

SMBJ Transient Voltage Suppressor Diode Series

Electrical Characteristics (@ T_A = 25 °C Unless Otherwise Noted)

Unidirectional Device		Bidirectional Device		Breakdown Voltage V _{BR} (Volts)			Working Peak Reverse Voltage	Maximum Reverse Leakage @ V _{RWM}	Maximum Clamping Voltage @ I _{pp} (10/1000 μs)	Maximum Peak Pulse Current (10/1000 μs)	Maximum Clamping Voltage @ I _{pp} (8/20 μs)	Maximum Peak Pulse Current (8/20 μs)
Part No.	Marking	Part No.	Marking	Min.	Max.	@ I _T (mA)	V _{RWM} (V)	I _R (μA)	V _c (V)	I _{pp} (A)	V _c (V)	I _{pp} (A)
SMBJ5.0A	KE	SMBJ5.0CA	AE	6.40	7.00	10	5.0	800	9.2	65.3	12.0	326.5
SMBJ6.0A	KG	SMBJ6.0CA	AG	6.67	7.37	10	6.0	800	10.3	58.3	13.4	291.5
SMBJ6.5A	KK	SMBJ6.5CA	AK	7.22	7.98	10	6.5	500	11.2	53.6	14.6	268.0
SMBJ7.0A	KM	SMBJ7.0CA	AM	7.78	8.60	10	7.0	200	12.0	50.0	15.6	250.0
SMBJ7.5A	KP	SMBJ7.5CA	AP	8.33	9.21	1.0	7.5	100	12.9	46.6	16.8	233.0
SMBJ8.0A	KR	SMBJ8.0CA	AR	8.89	9.83	1.0	8.0	50	13.6	44.2	17.7	221.0
SMBJ8.5A	KT	SMBJ8.5CA	AT	9.44	10.4	1.0	8.5	20	14.4	41.7	18.7	208.5
SMBJ9.0A	KV	SMBJ9.0CA	AV	10.0	11.1	1.0	9.0	10	15.4	39.0	20.0	195.0
SMBJ10A	KX	SMBJ10CA	AX	11.1	12.3	1.0	10	5.0	17.0	35.3	22.1	176.5
SMBJ11A	KZ	SMBJ11CA	AZ	12.2	13.5	1.0	11	1.0	18.2	33.0	23.7	165.0
SMBJ12A	LE	SMBJ12CA	BE	13.3	14.7	1.0	12	1.0	19.9	30.2	25.9	151.0
SMBJ13A	LG	SMBJ13CA	BG	14.4	15.9	1.0	13	1.0	21.5	28.0	28.0	140.0
SMBJ14A	LK	SMBJ14CA	BK	15.6	17.2	1.0	14	1.0	23.2	25.9	30.2	129.5
SMBJ15A	LM	SMBJ15CA	BM	16.7	18.5	1.0	15	1.0	24.4	24.6	31.7	123.0
SMBJ16A	LP	SMBJ16CA	BP	17.8	19.7	1.0	16	1.0	26.0	23.1	33.8	115.5
SMBJ17A	LR	SMBJ17CA	BR	18.9	20.9	1.0	17	1.0	27.6	21.8	35.9	109.0
SMBJ18A	LT	SMBJ18CA	BT	20.0	22.1	1.0	18	1.0	29.2	20.6	38.0	103.0
SMBJ20A	LV	SMBJ20CA	BV	22.2	24.5	1.0	20	1.0	32.4	18.6	42.1	93.0
SMBJ22A	LX	SMBJ22CA	BX	24.4	26.9	1.0	22	1.0	35.5	16.9	46.2	84.5
SMBJ24A	LZ	SMBJ24CA	BZ	26.7	29.5	1.0	24	1.0	38.9	15.5	50.6	77.5
SMBJ26A	ME	SMBJ26CA	CE	28.9	31.9	1.0	26	1.0	42.1	14.3	54.7	71.5
SMBJ28A	MG	SMBJ28CA	CG	31.1	34.4	1.0	28	1.0	45.4	13.3	59.0	66.5
SMBJ30A	MK	SMBJ30CA	CK	33.3	36.8	1.0	30	1.0	48.4	12.4	62.9	62.0
SMBJ33A	MM	SMBJ33CA	CM	36.7	40.6	1.0	33	1.0	53.3	11.3	69.3	56.5
SMBJ36A	MP	SMBJ36CA	CP	40	44.2	1.0	36	1.0	58.1	10.4	75.5	52.0
SMBJ40A	MR	SMBJ40CA	CR	44.4	49.1	1.0	40	1.0	64.5	9.3	83.9	46.5
SMBJ43A	MT	SMBJ43CA	CT	47.8	52.8	1.0	43	1.0	69.4	8.7	90.2	43.5
SMBJ45A	MV	SMBJ45CA	CV	50	55.3	1.0	45	1.0	72.7	8.3	94.5	41.5
SMBJ48A	MX	SMBJ48CA	CX	53.3	58.9	1.0	48	1.0	77.4	7.8	100.6	39.0
SMBJ51A	MZ	SMBJ51CA	CZ	56.7	62.7	1.0	51	1.0	82.4	7.3	107.1	36.5
SMBJ54A	NE	SMBJ54CA	DE	60	66.3	1.0	54	1.0	87.1	6.9	113.2	34.5
SMBJ58A	NG	SMBJ58CA	DG	64.4	71.2	1.0	58	1.0	93.6	6.5	121.7	32.5
SMBJ60A	NK	SMBJ60CA	DK	66.7	73.7	1.0	60	1.0	96.8	6.2	125.8	31.0
SMBJ64A	NM	SMBJ64CA	DM	71.1	78.6	1.0	64	1.0	103.1	5.9	133.9	29.5
SMBJ70A	NP	SMBJ70CA	DP	77.8	86.0	1.0	70	1.0	113	5.3	146.9	26.5
SMBJ75A	NR	SMBJ75CA	DR	83.3	92.1	1.0	75	1.0	121	5.0	157.3	25.0
SMBJ78A	NT	SMBJ78CA	DT	86.7	95.8	1.0	78	1.0	126	4.8	163.8	24.0
SMBJ85A	NV	SMBJ85CA	DV	94.4	104	1.0	85	1.0	137	4.4	178.1	22.0
SMBJ90A	NX	SMBJ90CA	DX	100	111	1.0	90	1.0	146	4.1	189.8	20.5
SMBJ100A	NZ	SMBJ100CA	DZ	111	123	1.0	100	1.0	162	3.7	210.6	18.5
SMBJ110A	PE	SMBJ110CA	EE	122	135	1.0	110	1.0	177	3.4	230.1	17.0
SMBJ120A	PG	SMBJ120CA	EG	133	147	1.0	120	1.0	193	3.1	250.9	15.5
SMBJ130A	PK	SMBJ130CA	EK	144	159	1.0	130	1.0	209	2.9	271.7	14.5
SMBJ150A	PM	SMBJ150CA	EM	167	185	1.0	150	1.0	243	2.5	315.9	12.5
SMBJ160A	PP	SMBJ160CA	EP	178	197	1.0	160	1.0	259	2.3	336.7	11.5
SMBJ170A	PR	SMBJ170CA	ER	189	209	1.0	170	1.0	275	2.2	357.5	11.0
SMBJ180A	PT	SMBJ180CA	ET	201	222	1.0	180	1.0	292	2.1	379.6	10.5
SMBJ200A	PV	SMBJ200CA	EV	224	247	1.0	200	1.0	324	1.9	421.2	9.5
SMBJ220A	PX	SMBJ220CA	EX	246	272	1.0	220	1.0	356	1.7	462.8	8.5
SMBJ250A	PZ	SMBJ250CA	EZ	279	309	1.0	250	1.0	405	1.5	526.5	7.5
SMBJ300A	QE	SMBJ300CA	WE	335	371	1.0	300	1.0	486	1.3	631.8	6.5
SMBJ350A	QG	SMBJ350CA	WG	391	432	1.0	350	1.0	567	1.1	737.1	5.5
SMBJ376A	376A	SMBJ376CA	376C	418	462	1.0	376	1.0	602	1.0	782.6	5.0
SMBJ400A	400A	SMBJ400CA	400C	447	494	1.0	400	1.0	648	0.9	842.4	4.5
SMBJ408A	408A	SMBJ408CA	408C	456	504	1.0	408	1.0	658	0.9	855.4	4.6
SMBJ440A	440A	SMBJ440CA	440C	492	543	1.0	440	1.0	713	0.9	926.9	4.5
SMBJ495A	495A	SMBJ495CA	495C	522	578	1.0	495	1.0	760	0.8	988.0	3.9

Notes:

- Suffix 'A' denotes a 5 % tolerance unidirectional device.
- Suffix 'CA' denotes a 5 % tolerance bidirectional device.
- For bidirectional devices with a V_R of 10 volts or less, the I_R limit is double.

Specifications are subject to change without notice.

Users should verify actual device performance in their specific applications.

The products described herein and this document are subject to specific legal disclaimers as set forth on the last page of this document, and at www.bourns.com/docs/legal/disclaimer.pdf.

SMBJ Transient Voltage Suppressor Diode Series

BOURNS®

Product Dimensions



Dimension	SMB (DO-214AA)
A	$\frac{4.06 - 4.57}{(0.160 - 0.180)}$
B	$\frac{3.30 - 3.94}{(0.130 - 0.155)}$
C	$\frac{1.95 - 2.20}{(0.077 - 0.087)}$
D	$\frac{0.15 - 0.31}{(0.006 - 0.012)}$
E	$\frac{5.21 - 5.59}{(0.205 - 0.220)}$
F	$\frac{0.05 - 0.203}{(0.002 - 0.008)}$
G	$\frac{2.13 - 2.44}{(0.084 - 0.096)}$
H	$\frac{0.76 - 1.52}{(0.030 - 0.060)}$

DIMENSIONS: $\frac{\text{MM}}{\text{(INCHES)}}$

Recommended Footprint



Dimension	SMB (DO-214AA)
A (Max.)	$\frac{2.69}{(0.106)}$
B (Min.)	$\frac{2.10}{(0.083)}$
C (Min.)	$\frac{1.27}{(0.050)}$

DIMENSIONS: $\frac{\text{MM}}{\text{(INCHES)}}$

Physical Specifications

Case Molded plastic per UL Class 94V-0
 Polarity.....Cathode band indicates unidirectional device
 No cathode band indicates bidirectional device
 Weight 0.093 grams

Specifications are subject to change without notice.

Users should verify actual device performance in their specific applications.

The products described herein and this document are subject to specific legal disclaimers as set forth on the last page of this document, and at www.bourns.com/docs/legal/disclaimer.pdf.

SMBJ Transient Voltage Suppressor Diode Series

BOURNS®

Rating & Characteristic Curves

Pulse Derating Curve

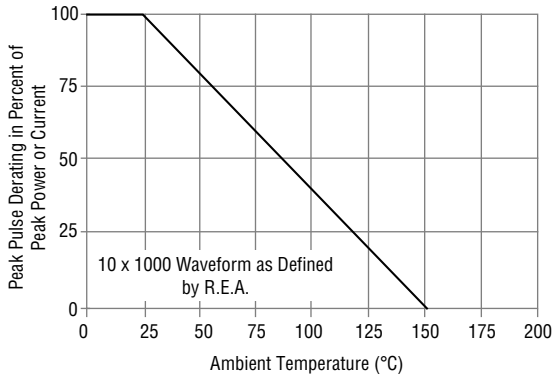

Maximum Non-Repetitive Surge Current

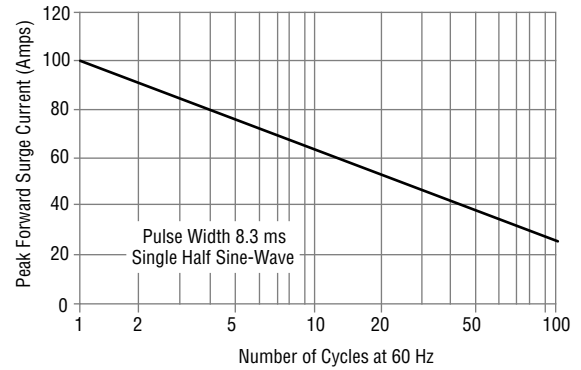

Pulse Waveform

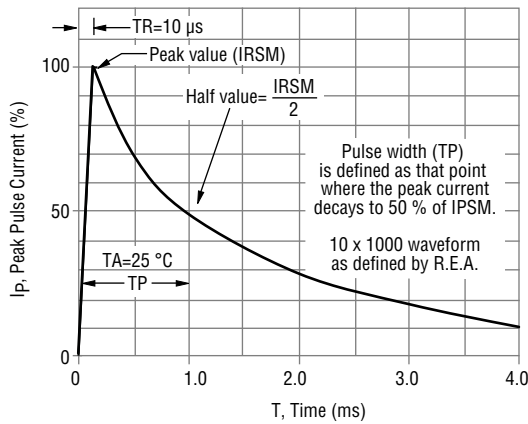

Typical Junction Capacitance

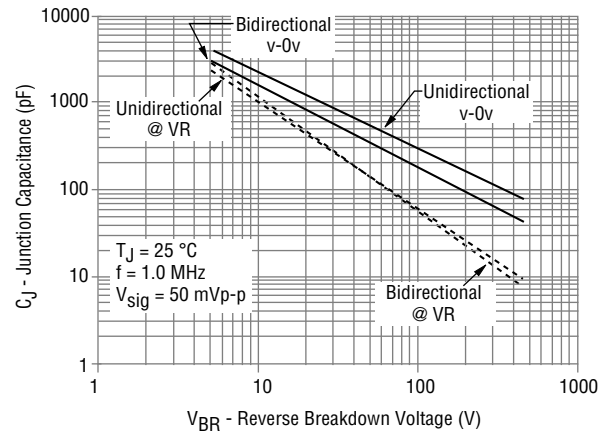

Pulse Rating Curve

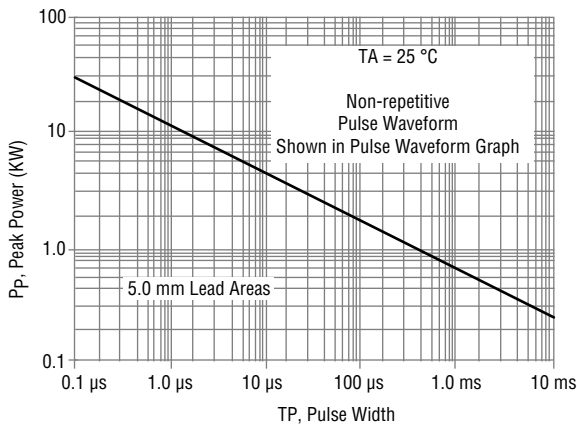

Steady State Power Derating Curve

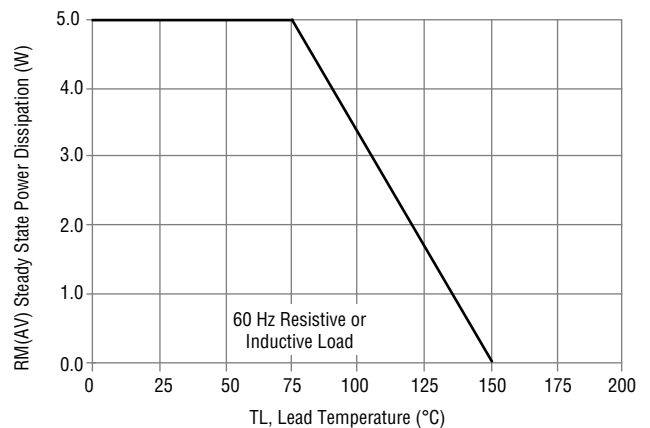

Specifications are subject to change without notice.

Users should verify actual device performance in their specific applications.

The products described herein and this document are subject to specific legal disclaimers as set forth on the last page of this document, and at www.bourns.com/docs/legal/disclaimer.pdf.

SMBJ Transient Voltage Suppressor Diode Series

BOURNS®

Packaging Information

The product will be dispensed in tape and reel format (see diagram below).

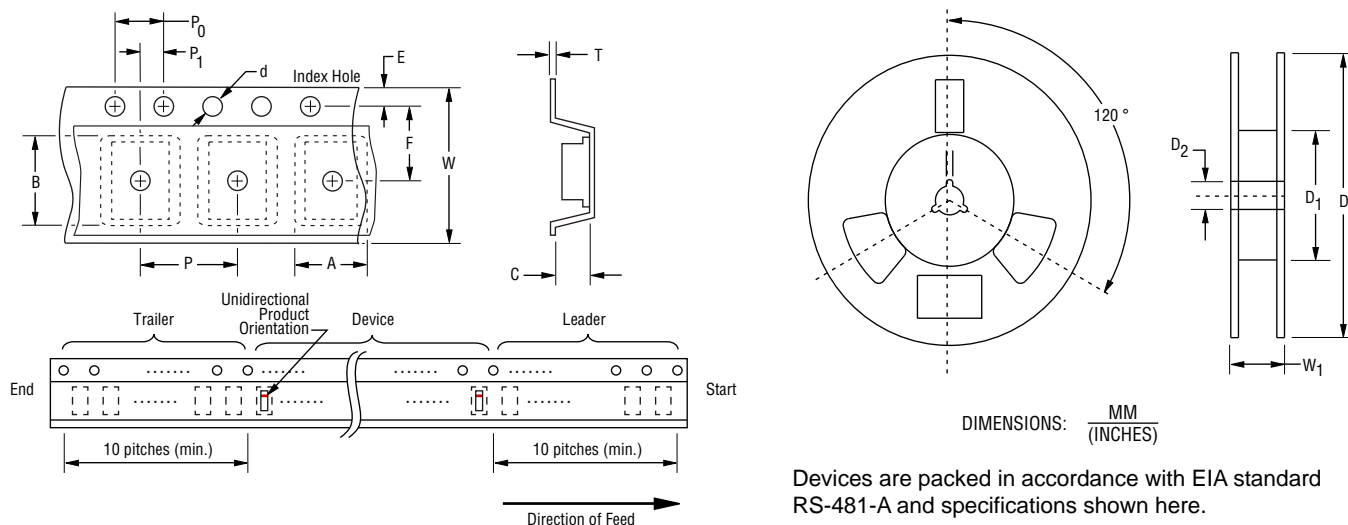

Devices are packed in accordance with EIA standard RS-481-A and specifications shown here.

Item	Symbol	SMB (DO-214AA)	
		7 Inch Reel	13 Inch Reel
Carrier Width	A	3.67 ± 0.20 (0.144 ± 0.008)	
Carrier Length	B	5.60 ± 0.20 (0.220 ± 0.008)	
Carrier Depth	C	2.57 ± 0.20 (0.101 ± 0.008)	
Sprocket Hole	d	1.50 ± 0.10 (0.059 ± 0.004)	
Reel Outside Diameter	D	178 (7.008)	330 (12.992)
Reel Inner Diameter	D ₁	50.0 (1.969) MIN.	
Feed Hole Diameter	D ₂	13.0 ± 0.20 (0.512 ± 0.008)	
Sprocket Hole Position	E	1.75 ± 0.10 (0.069 ± 0.004)	
Punch Hole Position	F	5.50 ± 0.05 (0.217 ± 0.002)	
Punch Hole Pitch	P	8.00 ± 0.10 (0.315 ± 0.004)	
Sprocket Hole Pitch	P ₀	4.00 ± 0.10 (0.157 ± 0.004)	
Embossment Center	P ₁	2.00 ± 0.05 (0.079 ± 0.002)	
Overall Tape Thickness	T	0.30 ± 0.10 (0.012 ± 0.004)	
Tape Width	W	12.00 ± 0.30 (0.472 ± 0.012)	
Reel Width	W ₁	18.4 (0.724) MAX.	
Quantity per Reel	--	500	3,000

REV. 09/20

Specifications are subject to change without notice.

Users should verify actual device performance in their specific applications.

The products described herein and this document are subject to specific legal disclaimers as set forth on the last page of this document, and at www.bourns.com/docs/legal/disclaimer.pdf.

This legal disclaimer applies to purchasers and users of Bourns® products manufactured by or on behalf of Bourns, Inc. and its affiliates (collectively, “Bourns”).

Unless otherwise expressly indicated in writing, Bourns® products and data sheets relating thereto are subject to change without notice. Users should check for and obtain the latest relevant information and verify that such information is current and complete before placing orders for Bourns® products.

The characteristics and parameters of a Bourns® product set forth in its data sheet are based on laboratory conditions, and statements regarding the suitability of products for certain types of applications are based on Bourns’ knowledge of typical requirements in generic applications. The characteristics and parameters of a Bourns® product in a user application may vary from the data sheet characteristics and parameters due to (i) the combination of the Bourns® product with other components in the user’s application, or (ii) the environment of the user application itself. The characteristics and parameters of a Bourns® product also can and do vary in different applications and actual performance may vary over time. Users should always verify the actual performance of the Bourns® product in their specific devices and applications, and make their own independent judgments regarding the amount of additional test margin to design into their device or application to compensate for differences between laboratory and real world conditions.

Unless Bourns has explicitly designated an individual Bourns® product as meeting the requirements of a particular industry standard (e.g., ISO/TS 16949) or a particular qualification (e.g., UL listed or recognized), Bourns is not responsible for any failure of an individual Bourns® product to meet the requirements of such industry standard or particular qualification. Users of Bourns® products are responsible for ensuring compliance with safety-related requirements and standards applicable to their devices or applications.

Bourns® products are not recommended, authorized or intended for use in nuclear, lifesaving, life-critical or life-sustaining applications, nor in any other applications where failure or malfunction may result in personal injury, death, or severe property or environmental damage. Unless expressly and specifically approved in writing by two authorized Bourns representatives on a case-by-case basis, use of any Bourns® products in such unauthorized applications might not be safe and thus is at the user’s sole risk. Life-critical applications include devices identified by the U.S. Food and Drug Administration as Class III devices and generally equivalent classifications outside of the United States.

Bourns expressly identifies those Bourns® standard products that are suitable for use in automotive applications on such products’ data sheets in the section entitled “Applications.” Unless expressly and specifically approved in writing by two authorized Bourns representatives on a case-by-case basis, use of any other Bourns® standard products in an automotive application might not be safe and thus is not recommended, authorized or intended and is at the user’s sole risk. If Bourns expressly identifies a sub-category of automotive application in the data sheet for its standard products (such as infotainment or lighting), such identification means that Bourns has reviewed its standard product and has determined that if such Bourns® standard product is considered for potential use in automotive applications, it should only be used in such sub-category of automotive applications. Any reference to Bourns® standard product in the data sheet as compliant with the AEC-Q standard or “automotive grade” does not by itself mean that Bourns has approved such product for use in an automotive application.

Bourns® standard products are not tested to comply with United States Federal Aviation Administration standards generally or any other generally equivalent governmental organization standard applicable to products designed or manufactured for use in aircraft or space applications. Bourns expressly identifies Bourns® standard products that are suitable for use in aircraft or space applications on such products’ data sheets in the section entitled “Applications.” Unless expressly and specifically approved in writing by two authorized Bourns representatives on a case-by-case basis, use of any other Bourns® standard product in an aircraft or space application might not be safe and thus is not recommended, authorized or intended and is at the user’s sole risk.

The use and level of testing applicable to Bourns® custom products shall be negotiated on a case-by-case basis by Bourns and the user for which such Bourns® custom products are specially designed. Absent a written agreement between Bourns and the user regarding the use and level of such testing, the above provisions applicable to Bourns® standard products shall also apply to such Bourns® custom products.

Users shall not sell, transfer, export or re-export any Bourns® products or technology for use in activities which involve the design, development, production, use or stockpiling of nuclear, chemical or biological weapons or missiles, nor shall they use Bourns® products or technology in any facility which engages in activities relating to such devices. The foregoing restrictions apply to all uses and applications that violate national or international prohibitions, including embargos or international regulations. Further, Bourns® products and Bourns technology and technical data may not under any circumstance be exported or re-exported to countries subject to international sanctions or embargoes. Bourns® products may not, without prior authorization from Bourns and/or the U.S. Government, be resold, transferred, or re-exported to any party not eligible to receive U.S. commodities, software, and technical data.

To the maximum extent permitted by applicable law, Bourns disclaims (i) any and all liability for special, punitive, consequential, incidental or indirect damages or lost revenues or lost profits, and (ii) any and all implied warranties, including implied warranties of fitness for particular purpose, non-infringement and merchantability.

For your convenience, copies of this Legal Disclaimer Notice with German, Spanish, Japanese, Traditional Chinese and Simplified Chinese bilingual versions are available at:

Web Page: <http://www.bourns.com/legal/disclaimers-terms-and-policies>

PDF: <http://www.bourns.com/docs/Legal/disclaimer.pdf>

Looking for pricing, stock, or lifecycle information?

Click below to explore more details on WIN SOURCE:

 [View SMBJ400A-H on WIN SOURCE](#)

 [Bourns Inc. Information](#)

Optimize Your Supply Chain with WIN SOURCE Solutions

-  Global Sourcing Solution
-  Obsolete Management
-  Cost Control Management
-  Shortage Management
-  Alternative Solution
-  Excess Inventory Management