



**THE DATASHEET OF
SLD12-018-B**



SLD Series



Agency Approvals

Agency	Agency File Number
	E230531

Maximum Ratings and Thermal Characteristics (T_A=25°C unless otherwise noted)

Parameter	Symbol	Value	Unit
Peak Pulse Power Dissipation 10ms x 150ms Test Waveform	P _{PPM}	2200	W
Peak Pulse Power Dissipation 10µs x 1000µs Test Waveform	P _{PPM}	5000	W
Steady State Power Dissipation on Infinite Heat Sink at T _A =75°C (Fig. 6)	P _D	8.0	W
Peak Forward Surge Current, 8.3ms Single Half Sine Wave (Note 3)	I _{FSM}	600	A
Maximum Instantaneous Forward Voltage at 100A for Unidirectional Only	V _F	3.5	V
Operating Junction and Storage Temperature Range	T _J , T _{STG}	-55 to 175	°C
Typical Thermal Resistance Junction to Lead	R _{θJL}	8.0	°C/W
Typical Thermal Resistance Junction to Ambient	R _{θJA}	40	°C/W

Functional Diagram



Description

The AEC-Q101 qualified SLD Series is packaged in a highly reliable industry standard P600 axial leaded package and is designed to provide precision overvoltage protection for sensitive electronics.

Features

- High reliability application and automotive grade AEC-Q101 qualified with T_J 175°C
- V_{BR} @ T_J = V_{BR} @ 25°C x (1 + α T x (T_J - 25)) (α T: Temperature Coefficient, typical value is 0.1%)
- Glass passivated chip junction in P600 package
- Meets ISO7637 and ISO16750 load dump test; 2200W peak pulse capability at 10µs x 150ms waveform, repetition rate (duty cycles): 0.01%
- Fast response time: typically less than 1.0ps from 0 Volts to V_{BR} min
- Excellent clamping capability
- Typical failure mode is short from over-specified voltage or current
- Whisker test is conducted based on JEDEC JESD201A per its table 4a and 4c
- IEC-61000-4-2 ESD 30kV(Air), 30kV (Contact)
- ESD protection of data lines in accordance with IEC 61000-4-2
- EFT protection of data lines in accordance with IEC 61000-4-4
- Low incremental surge resistance
- High temperature to reflow soldering guaranteed: 260°C/10sec / 0.375" (9.5mm) lead length, 5 lbs., (2.3kg) tension
- UL Recognized case material meeting flammability rating V-0.
- Matte tin lead-free plated
- Halogen free and RoHS compliant
- Pb-free E3 means 2nd level interconnect is Pb-free and the terminal finish material is tin(Sn) (IPC/ JEDEC J-STD-609A.01)

Applications

Designed to protect sensitive electronics from:

- Inductive Load Switching
- Alternator Load Dump

Electrical Characteristics ($T_A=25^\circ\text{C}$ unless otherwise noted)

Part Number (Uni)	Part Number (Bi)	Breakdown Voltage V_{BR} @ I_T (V)		Test Current I_T (mA)	Reverse Stand off Voltage V_R (Volts)	Maximum Reverse Leakage @ V_R I_R (μA)	Maximum Peak Pulse Current I_{PP} (A)	Maximum Clamping Voltage @ I_{PP} V_C (V)	Agency Approval 
		MIN	MAX						
SLD10U-017	SLD10-018	11.8	13.0	5.0	10	10	300.0	17.0	x
SLD11U-017	SLD11-018	12.2	13.5	5.0	11	10	280.2	18.2	x
SLD12U-017	SLD12-018	13.3	14.7	5.0	12	10	256.3	19.9	x
SLD13U-017	SLD13-018	14.4	15.9	5.0	13	10	237.2	21.5	x
SLD14U-017	SLD14-018	15.6	17.2	5.0	14	10	219.8	23.2	x
SLD15U-017	SLD15-018	16.7	18.5	5.0	15	10	209.0	24.4	x
SLD16U-017	SLD16-018	18.0	19.3	5.0	16	10	196.2	26.0	x
SLD17U-017	SLD17-018	18.9	20.9	5.0	17	10	184.8	27.6	x
SLD18U-017	SLD18-018	20.0	22.1	5.0	18	10	174.7	29.2	x
SLD20U-017	SLD20-018	22.2	24.5	5.0	20	10	157.4	32.4	x
SLD22U-017	SLD22-018	24.4	26.9	5.0	22	10	143.7	35.5	x
SLD24U-017	SLD24-018	26.7	29.5	5.0	24	10	131.1	38.9	x
SLD26U-017	SLD26-018	28.9	31.9	5.0	26	10	121.1	42.1	x
SLD28U-017	SLD28-018	31.1	34.4	5.0	28	10	112.3	45.4	x
SLD30U-017	SLD30-018	33.3	36.8	5.0	30	10	105.4	48.4	x
SLD33U-017	SLD33-018	36.7	40.6	5.0	33	10	95.7	53.3	x
SLD36U-017	SLD36-018	40.0	44.2	5.0	36	10	87.8	58.1	x
SLD40U-017	SLD40-018	44.4	49.1	5.0	40	10	79.1	64.5	x
SLD43U-017	SLD43-018	49.0	54.2	5.0	43	10	73.5	69.4	x
SLD45U-017	SLD45-018	50.0	55.3	5.0	45	10	70.2	72.7	x
SLD48U-017	SLD48-018	53.3	58.9	5.0	48	10	65.9	77.4	x
SLD51U-017	SLD51-018	56.7	62.7	5.0	51	10	61.9	82.4	x
SLD54U-017	SLD54-018	60.0	66.3	5.0	54	10	58.6	87.1	x
SLD58U-017	SLD58-018	64.4	71.2	5.0	58	10	54.5	93.6	x
SLD60U-017	SLD60-018	68.4	75.6	5.0	60	10	52.7	96.8	x

Notes:

- V_{BR} measured after I_T applied for 300 μs , I_T = square wave pulse or equivalent.
- Surge current waveform per 10 μs x 1000 μs exponential wave and derated per Fig. 4.
- All terms and symbols are consistent with ANSI/IEEE C62.35

Load Dump Test Wave Form

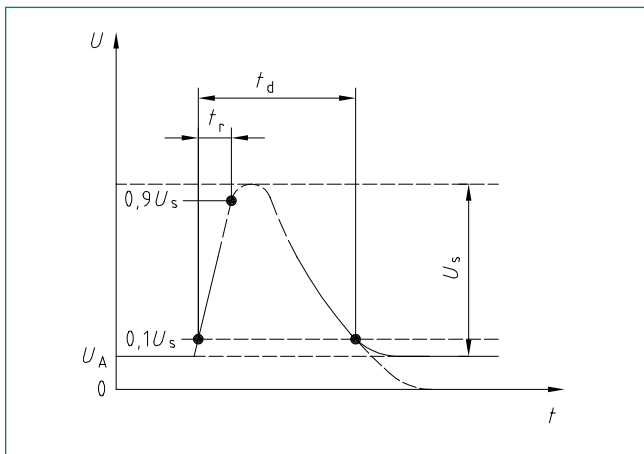

Note: LF use $t_d=400\text{ms}$ for 12V system test; $t_d=350\text{ms}$ for 24V system

Parameter	12V system	24V system
U_s	65V to 87V	123V to 174V
R_i	0.5 Ω to 4 Ω	1 Ω to 8 Ω
t_d	40 ms to 400 ms	100 ms to 350 ms
t_r	(10 $^{-0.5}$)ms	

I-V Curve Characteristics



- P_{PPM} Peak Pulse Power Dissipation** ($I_{PP} \times V_C$) – Max power dissipation
- V_R Stand-off Voltage** – Maximum voltage that can be applied to the TVS without operation
- V_{BR} Breakdown Voltage** – Maximum voltage that flows through the TVS at a specified test current (I_T)
- V_C Clamping Voltage** – Peak voltage measured across the TVS at a specified I_{ppm} (peak impulse current)
- I_R Reverse Leakage Current** – Current measured at V_R
- V_F Forward Voltage Drop for Uni-directional**

Ratings and Characteristic Curves ($T_A=25^\circ\text{C}$ unless otherwise noted)

Figure 1 - TVS Transients Clamping Waveform



Figure 2 - Peak Pulse Power Rating Curve



Figure 3 - Peak Pulse Power Derating Curve



Figure 4 - Typical Junction Capacitance



Figure 5 - Maximum Non-Repetitive Peak Forward Surge Current

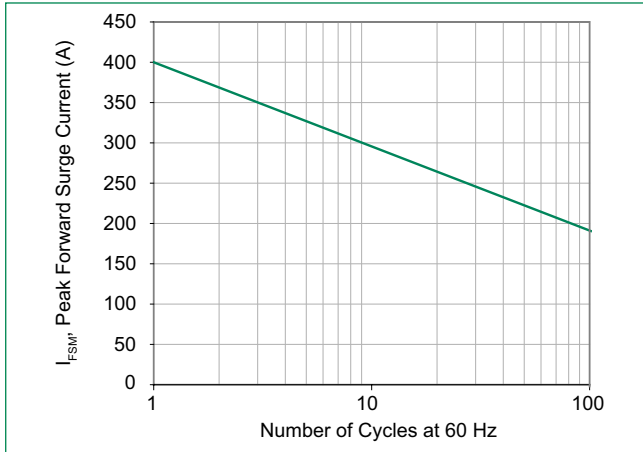
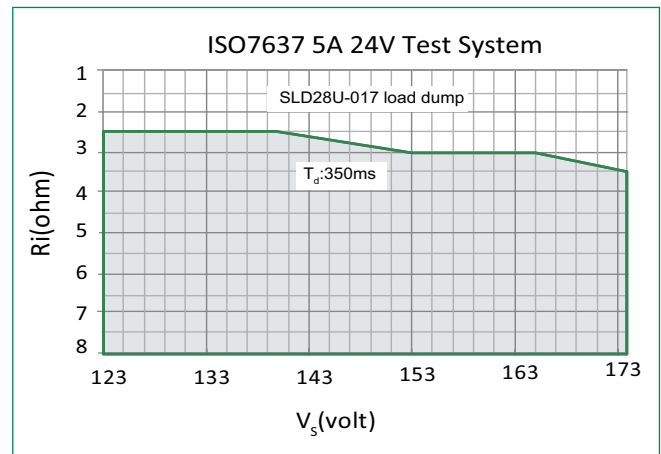
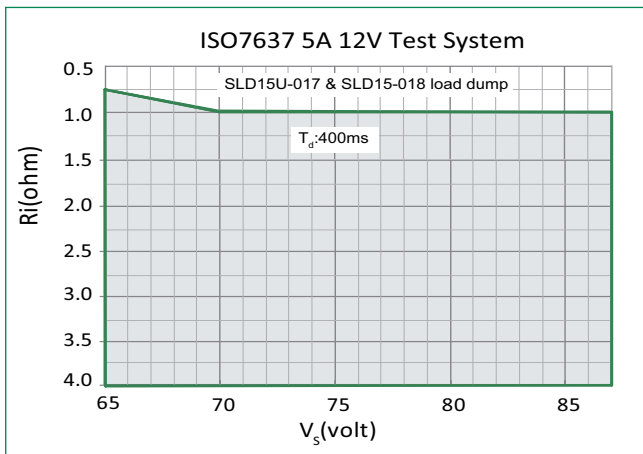

Figure 6 - SOA Chart



Soldering Parameters

Flow/Wave Soldering (Solder Dipping)

Peak Temperature :	265°C
Dipping Time :	10 seconds
Soldering :	1 time

Physical Specifications

Weight	0.07oz., 2.1g
Case	P600 molded plastic body over passivated junction.
Polarity	Color band denotes cathode for unidirectional components
Terminal	Matte Tin axial leads, solderable per JESD22-B102.

Environmental Specifications

High Temp. Storage	JESD22-A103
HTRB	JESD22-A108
Temperature Cycling	JESD22-A104
H3TRB	JESD22-A101
RSH	JESD22-B106

Dimensions

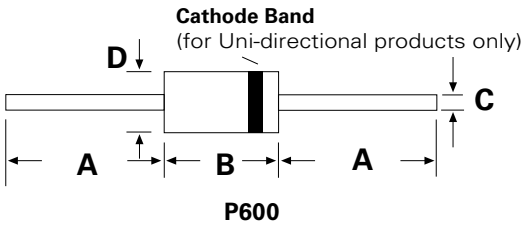

Dimensions	Inches		Millimeters	
	Min	Max	Min	Max
A	1.000	-	25.40	-
B	0.340	0.360	8.60	9.10
C	0.048	0.054	1.22	1.36
D	0.340	0.360	8.60	9.10

Part Numbering System

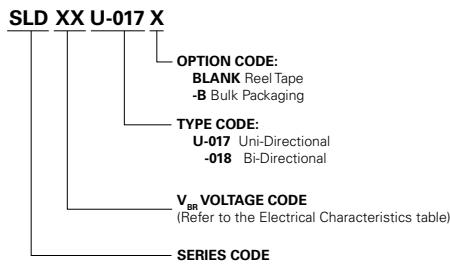

Part Marking System

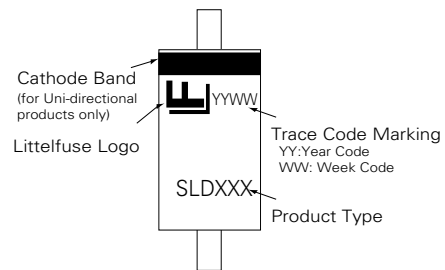

Packing Options

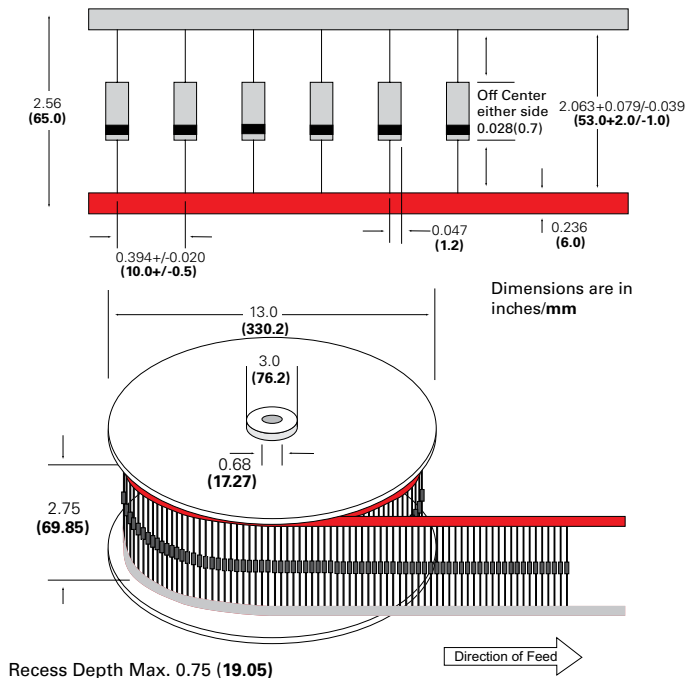

Part Number	Component Package	Quantity	Packaging Option	Packaging Specification
SLDxxXXX	P600	800	Tape & Reel	EIA STD RS-296
SLDxxXX-B	P600	100	BOX	Littelfuse Spec.

Tape and Reel Specification



Looking for pricing, stock, or lifecycle information?

Click below to explore more details on WIN SOURCE:

-  [View SLD12-018-B on WIN SOURCE](#)
-  [Littelfuse Inc. Information](#)

Optimize Your Supply Chain with WIN SOURCE Solutions

-  Global Sourcing Solution
-  Obsolete Management
-  Cost Control Management
-  Shortage Management
-  Alternative Solution
-  Excess Inventory Management