

SA Series



Agency Approvals

Agency	Agency File Number
	E230531

Maximum Ratings and Thermal Characteristics (T_A = 25°C unless otherwise noted)

Parameter	Symbol	Value	Unit
Peak Pulse Power Dissipation by 10/1000µs Test Waveform (Fig.2)(Note 1)	P _{PPM}	500	W
Steady State Power Dissipation on Infinite Heat Sink at T _L = 75°C	P _D	3.0	W
Peak Forward Surge Current, 8.3ms Single Half Sine Wave Unidirectional Only (Note 2)	I _{FSM}	70	A
Maximum Instantaneous Forward Voltage at 35A for Unidirectional Only	V _F	3.5	V
Operating Junction and Storage Temperature Range	T _J , T _{STG}	-65 to 175	°C
Typical Thermal Resistance Junction to Lead	R _{θJL}	20	°C/W
Typical Thermal Resistance Junction to Ambient	R _{θJA}	75	°C/W

Notes:
 1. Non-repetitive current pulse, per Fig. 4 and derated above T_J (initial) = 25°C per Fig. 3.
 2. Measured on 8.3ms single half sine wave or equivalent square wave, duty cycle=4 per minute maximum.

Functional Diagram



Description

The SA Series is designed specifically to protect sensitive electronic equipment from voltage transients induced by lightning and other transient voltage events.

Features

- 500W peak pulse capability at 10/1000µs waveform, repetition rate (duty cycles):0.01 %
- V_{BR} @ T_J = V_{BR} @ 25°C x (1 + α T (T_J - 25)) (α T: Temperature Coefficient, typical value is 0.1 %)
- Glass passivated chip junction in DO-15 Package
- Fast response time: typically less than 1.0ps from 0 Volts to BV min
- Excellent clamping capability
- Typical failure mode is short from over-specified voltage or current
- Whisker test is conducted based on JEDEC JESD201A per its table 4a and 4c
- IEC-61000-4-2 ESD 30kV(Air), 30kV (Contact)
- ESD protection of data lines in accordance with IEC 61000-4-2
- EFT protection of data lines in accordance with IEC 61000-4-4
- Low incremental surge resistance
- Typical I_R less than 1µA when V_{BR} max > 13V
- High temperature to reflow soldering guaranteed: 260°C/40sec / 0.375"/(9.5mm) lead length, 5 lbs., (2.3kg) tension
- Plastic package is flammability rated V-0 per Underwriters Laboratories
- Matte tin lead-free plated
- Halogen free and RoHS compliant
- Pb-free E3 means 2nd level interconnect is Pb-free and the terminal finish material is tin(Sn) (IPC/ JEDEC J-STD-609A.01)

Applications

TVS devices are ideal for the protection of I/O interfaces, V_{CC} bus and other vulnerable circuits used in telecom, computer, industrial and consumer electronic applications.

Additional Information



Electrical Characteristics (T_A=25°C unless otherwise noted)

Part Number (Uni)	Part Number (Bi)	Reverse Stand off Voltage V _R (V)	Breakdown Voltage V _{BR} (Volts) @ I _T		Test Current I _T (mA)	Maximum Clamping Voltage V _C @ I _{pp} (V)	Maximum Peak Pulse Current I _{pp} (A)	Maximum Reverse Leakage I _R @ V _R (μA)	Agency Approval 
			Min.	Max.					
SA5.0A	SA5.0CA	5.0	6.40	7.00	10	9.2	55.4	600	X
SA6.0A	SA6.0CA	6.0	6.67	7.37	10	10.3	49.5	600	X
SA6.5A	SA6.5CA	6.5	7.22	7.98	10	11.2	45.5	400	X
SA7.0A	SA7.0CA	7.0	7.78	8.60	10	12.0	42.5	150	X
SA7.5A	SA7.5CA	7.5	8.33	9.21	1	12.9	39.5	50	X
SA8.0A	SA8.0CA	8.0	8.89	9.83	1	13.6	37.5	25	X
SA8.5A	SA8.5CA	8.5	9.44	10.40	1	14.4	35.4	10	X
SA9.0A	SA9.0CA	9.0	10.00	11.10	1	15.4	33.1	5	X
SA10A	SA10CA	10.0	11.10	12.30	1	17.0	30.0	3	X
SA11A	SA11CA	11.0	12.20	13.50	1	18.2	28.0	1	X
SA12A	SA12CA	12.0	13.30	14.70	1	19.9	25.6	1	X
SA13A	SA13CA	13.0	14.40	15.90	1	21.5	23.7	1	X
SA14A	SA14CA	14.0	15.60	17.20	1	23.2	22.0	1	X
SA15A	SA15CA	15.0	16.70	18.50	1	24.4	20.9	1	X
SA16A	SA16CA	16.0	17.80	19.70	1	26.0	19.6	1	X
SA17A	SA17CA	17.0	18.90	20.90	1	27.6	18.5	1	X
SA18A	SA18CA	18.0	20.00	22.10	1	29.2	17.5	1	X
SA20A	SA20CA	20.0	22.20	24.50	1	32.4	15.7	1	X
SA22A	SA22CA	22.0	24.40	26.90	1	35.5	14.4	1	X
SA24A	SA24CA	24.0	26.70	29.50	1	38.9	13.1	1	X
SA26A	SA26CA	26.0	28.90	31.90	1	42.1	12.1	1	X
SA28A	SA28CA	28.0	31.10	34.40	1	45.4	11.2	1	X
SA30A	SA30CA	30.0	33.30	36.80	1	48.4	10.5	1	X
SA33A	SA33CA	33.0	36.70	40.60	1	53.3	9.6	1	X
SA36A	SA36CA	36.0	40.00	44.20	1	58.1	8.8	1	X
SA40A	SA40CA	40.0	44.40	49.10	1	64.5	7.9	1	X
SA43A	SA43CA	43.0	47.80	52.80	1	69.4	7.3	1	X
SA45A	SA45CA	45.0	50.00	55.30	1	72.7	7.0	1	X
SA48A	SA48CA	48.0	53.30	58.90	1	77.4	6.6	1	X
SA51A	SA51CA	51.0	56.70	62.70	1	82.4	6.2	1	X
SA54A	SA54CA	54.0	60.00	66.30	1	87.1	5.9	1	X
SA58A	SA58CA	58.0	64.40	71.20	1	93.6	5.4	1	X
SA60A	SA60CA	60.0	66.70	73.70	1	96.8	5.3	1	X
SA64A	SA64CA	64.0	71.10	78.60	1	103.0	5.0	1	X
SA70A	SA70CA	70.0	77.80	86.00	1	113.0	4.5	1	X
SA75A	SA75CA	75.0	83.30	92.10	1	121.0	4.2	1	X
SA78A	SA78CA	78.0	86.70	95.80	1	126.0	4.0	1	X
SA85A	SA85CA	85.0	94.40	104.00	1	137.0	3.7	1	X
SA90A	SA90CA	90.0	100.00	111.00	1	146.0	3.5	1	X
SA100A	SA100CA	100.0	111.00	123.00	1	162.0	3.1	1	X
SA110A	SA110CA	110.0	122.00	135.00	1	177.0	2.9	1	X
SA120A	SA120CA	120.0	133.00	147.00	1	193.0	2.6	1	X
SA130A	SA130CA	130.0	144.00	159.00	1	209.0	2.4	1	X
SA150A	SA150CA	150.0	167.00	185.00	1	243.0	2.1	1	X
SA160A	SA160CA	160.0	178.00	197.00	1	259.0	2.0	1	X
SA170A	SA170CA	170.0	189.00	209.00	1	275.0	1.9	1	X
SA180A	SA180CA	180.0	200.00	221.00	1	289.0	1.7	1	X

For bidirectional type having V_R of 10 volts and less, the I_R limit is double.

For parts without A, the V_{BR} is ± 10% and V_C is 5% higher than with A parts, the parts without A are currently available, but not recommended for new designs. The parts with A are preferred.

I-V Curve Characteristics

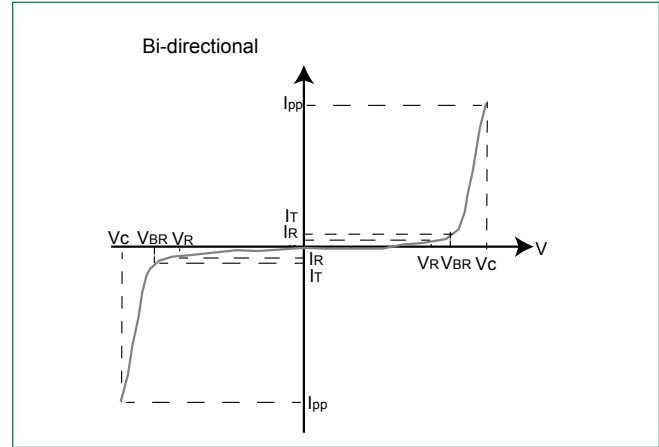

- P_{PPM} **Peak Pulse Power Dissipation** – Max power dissipation
- V_R **Stand-off Voltage** – Maximum voltage that can be applied to the TVS without operation
- V_{BR} **Breakdown Voltage** – Maximum voltage that flows through the TVS at a specified test current (I_T)
- V_C **Clamping Voltage** – Peak voltage measured across the TVS at a specified I_{ppm} (peak impulse current)
- I_R **Reverse Leakage Current** – Current measured at V_R
- V_F **Forward Voltage Drop for Uni-directional**

Ratings and Characteristic Curves ($T_A=25^\circ C$ unless otherwise noted)

Figure 1 - TVS Transients Clamping Waveform



Figure 2 - Peak Pulse Power Rating

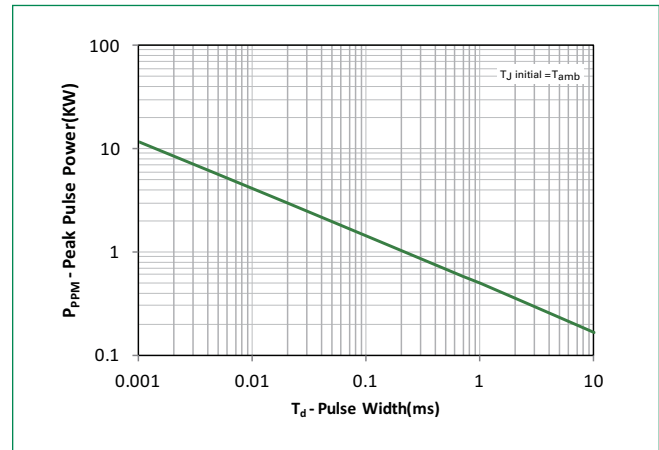

Ratings and Characteristic Curves ($T_A=25^\circ\text{C}$ unless otherwise noted) (Continued)

Figure 3 - Peak Pulse Power Derating Curve



Figure 4 - Pulse Waveform



Figure 5 - Typical Junction Capacitance



Figure 6 - Typical Transient Thermal Impedance



Figure 7 - Maximum Non-Repetitive Forward Surge Current Uni-Directional Only



Figure 8 - Peak Forward Voltage Drop vs Peak Forward Current (Typical Values)



Soldering Parameters

Reflow Condition		Lead-free assembly
Pre Heat	- Temperature Min ($T_{s(min)}$)	150°C
	- Temperature Max ($T_{s(max)}$)	200°C
	- Time (min to max) (t_s)	60 – 180 secs
Average ramp up rate (Liquidus Temp (T_A) to peak		3°C/second max
$T_{s(max)}$ to T_A - Ramp-up Rate		3°C/second max
Reflow	- Temperature (T_A) (Liquidus)	217°C
	- Time (min to max) (t_s)	60 – 150 seconds
Peak Temperature (T_p)		260 ^{+0/-5} °C
Time within 5°C of actual peak Temperature (t_p)		20 – 40 seconds
Ramp-down Rate		6°C/second max
Time 25°C to peak Temperature (T_p)		8 minutes Max.
Do not exceed		260°C



Flow/Wave Soldering (Solder Dipping)

Peak Temperature :	265°C
Dipping Time :	10 seconds
Soldering :	1 time

Physical Specifications

Weight	0.015oz., 0.4g
Case	JEDEC DO-204AC (DO-15) molded plastic body over passivated junction.
Polarity	Color band denotes the cathode except Bipolar.
Terminal	Matte Tin axial leads, solderable per JESD22-B102.

Environmental Specifications

High Temp. Storage	JESD22-A103
HTRB	JESD22-A108
Temperature Cycling	JESD22-A104
H3TRB	JESD22-A101
RSH	JESD22-B106

Dimensions



DO-204AC (DO-15)

Dimensions	Inches		Millimeters	
	Min	Max	Min	Max
A	1.000	-	25.40	-
B	0.230	0.300	5.80	7.60
C	0.028	0.034	0.71	0.86
D	0.104	0.140	2.60	3.60

Part Numbering System

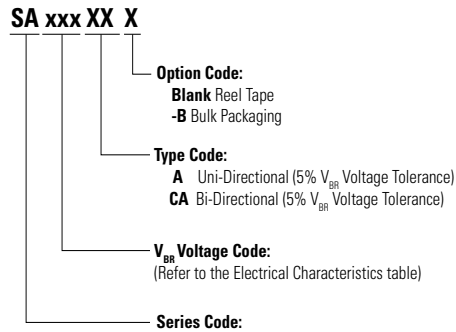

Part Marking System

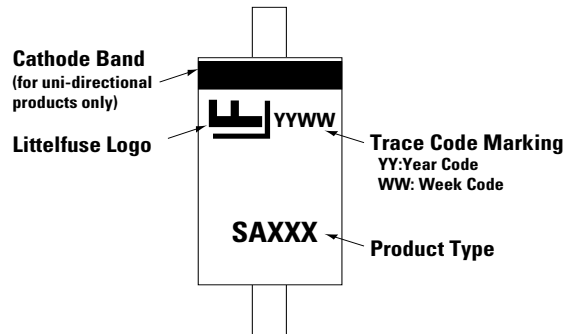

Packaging

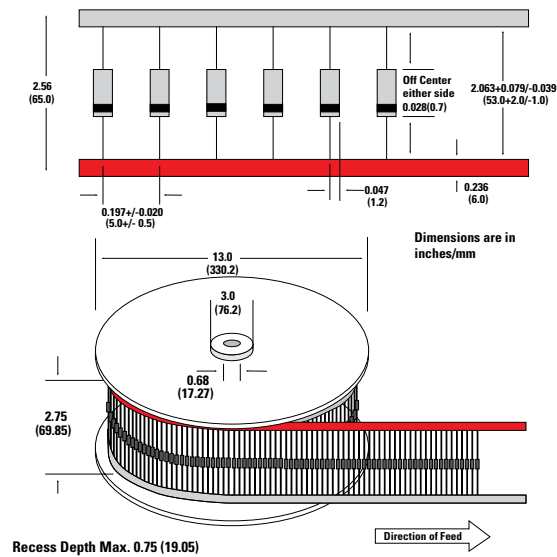

Part Number	Component Package	Quantity	Packaging Option	Packaging Specification
SAxxxXX	DO-204AC	4000	Tape & Reel	EIA STD RS-296
SAxxxXX-B	DO-204AC	1000	Bulk	Littelfuse Spec.

Tape and Reel Specification



Looking for pricing, stock, or lifecycle information?

Click below to explore more details on WIN SOURCE:

-  [View SA14A-B on WIN SOURCE](#)
-  [Littelfuse Inc. Information](#)

Optimize Your Supply Chain with WIN SOURCE Solutions

-  Global Sourcing Solution
-  Obsolete Management
-  Cost Control Management
-  Shortage Management
-  Alternative Solution
-  Excess Inventory Management