

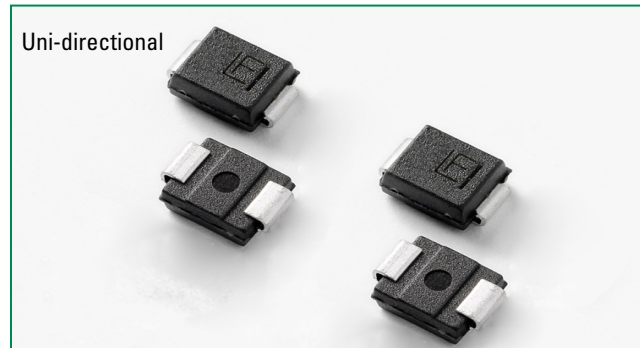



THE DATASHEET OF SACB18



SACB Series



Agency Approvals

AGENCY	AGENCY FILE NUMBER
	E230531

Maximum Ratings and Thermal Characteristics (T_A = 25°C unless otherwise noted)

Parameter	Symbol	Value	Unit
Peak Pulse Power Dissipation at T _L = 25°C by 10/1000µs Waveform (fig.1)(Note 1)	P _{PPM}	500	W
Power Dissipation on Infinite Heat Sink at T _L = 50°C	P _D	3.0	W
Operating Temperature Range	T _J	-65 to 150	°C
Storage Temperature Range	T _{STG}	-65 to 175	°C

Note:
1. Non-repetitive current pulse, per Fig. 3 and derated above T_J (initial) = 25°C per Fig. 2.

Description

SACB series is designed specifically to protect sensitive electronic equipment from voltage transients induced by lightning and other transient voltage events.

Features

- 500W peak pulse power capability at 10/1000µs waveform, repetition rate (duty cycles):0.01%
- For surface mounted applications in order to optimize board space
- Low profile package
- Built-in strain relief
- Typical failure mode is short from over-specified voltage or current
- Whisker test is conducted based on JEDEC JESD201A per its table 4a and 4c
- IEC-61000-4-2 ESD 30kV(Air), 30kV (Contact)
- ESD protection of data lines in accordance with IEC 61000-4-2
- EFT protection of data lines in accordance with IEC 61000-4-4
- V_{BR} @ T_J = V_{BR} @ 25°C x (1 + α T x (T_J - 25)) (α T: Temperature Coefficient, typical value is 0.1%)
- Glass passivated chip junction
- Fast response time: typically less than 1.0ps from 0V to BV min
- Excellent clamping capability
- Low incremental surge resistance
- High temperature to reflow soldering guaranteed: 260°C/40sec
- Plastic package is flammability rated V-0 per Underwriters Laboratories
- Meet MSL level1, per J-STD-020, LF maximum peak of 260°C
- Matte tin lead-free plated
- Halogen free and RoHS compliant
- Pb-free E3 means 2nd level interconnect is Pb-free and the terminal finish material is tin(Sn) (IPC/JEDEC J-STD-609A.01)

Additional Information



Datasheet



Resources



Samples

Applications

TVS devices are ideal for the protection of I/O Interfaces, V_{CC} bus and other vulnerable circuits used in Telecom, Computer, Industrial and Consumer electronic applications.

Electrical Characteristics ($T_A=25^\circ\text{C}$ unless otherwise noted)

Part Number	Marking Code	Stand-Off Voltage V_R (V)	Minimum Breakdown Voltage at $I_T = 1.0\text{mA}$ $V_{BR}(V)$	Maximum Reverse Leakage at $I_R @ V_R$ (μA)	Maximum Clamping Voltage at $I_{PP}=5.0\text{A}$ $V_C(V)$	Maximum Peak Pulse Current per (Fig.3) $I_{PP}(A)$	Maximum Junction Capacitance at 0 Volts (pF)	Working Inverse Blocking Voltage $V_{WIB}(V)$	Inverse Blocking Leakage Current at $V_{WIB} @ I_{IB}$ (mA)	Peak Inverse Blocking Voltage V_{PIB} (V)	Agency Approval
SACB5.0	SKE	5.0	7.60	300	10.0	44.0	45	75	1.0	100	X
SACB6.0	SKG	6.0	7.90	300	11.2	41.0	45	75	1.0	100	X
SACB7.0	SKM	7.0	8.33	300	12.6	38.0	45	75	1.0	100	X
SACB8.0	SKR	8.0	8.89	100	13.4	36.0	45	75	1.0	100	X
SACB8.5	SKT	8.5	9.44	50	14.0	34.0	45	75	1.0	100	X
SACB10	SKX	10.0	11.10	5	16.3	29.0	45	75	1.0	100	X
SACB12	SLE	12.0	13.30	5	19.0	25.0	45	75	1.0	100	X
SACB15	SLM	15.0	16.70	5	23.6	20.0	45	75	1.0	100	X
SACB18	SLT	18.0	20.00	5	28.8	15.0	45	75	1.0	100	X
SACB22	SLX	22.0	24.40	5	35.4	14.0	45	75	1.0	100	X
SACB26	SME	26.0	28.90	5	42.3	11.1	45	75	1.0	100	X
SACB30	SMK	30.0	33.30	5	48.6	10.0	45	75	1.0	100	X
SACB36	SMP	36.0	40.00	5	60.0	8.6	45	75	1.0	100	X
SACB45	SMV	45.0	50.00	5	77.0	6.8	45	150	1.0	200	X
SACB50	SMZ	50.0	55.50	5	88.0	5.8	45	150	1.0	200	X

Ratings and Characteristic Curves ($T_A = 25^\circ\text{C}$ unless otherwise noted)

Figure 1 - Peak Pulse Power Rating Curve

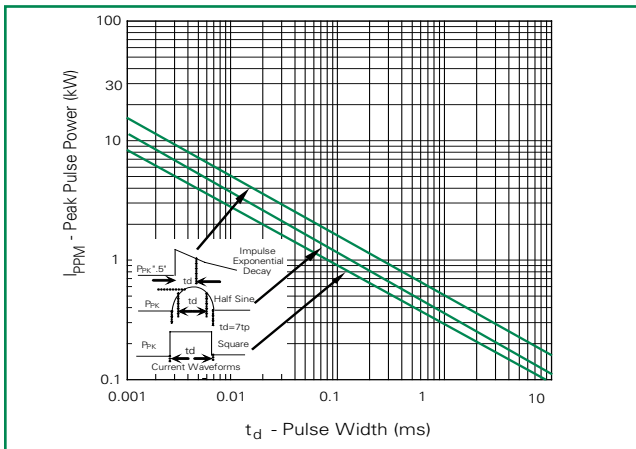

Figure 2 - Peak Pulse Power Derating Curve

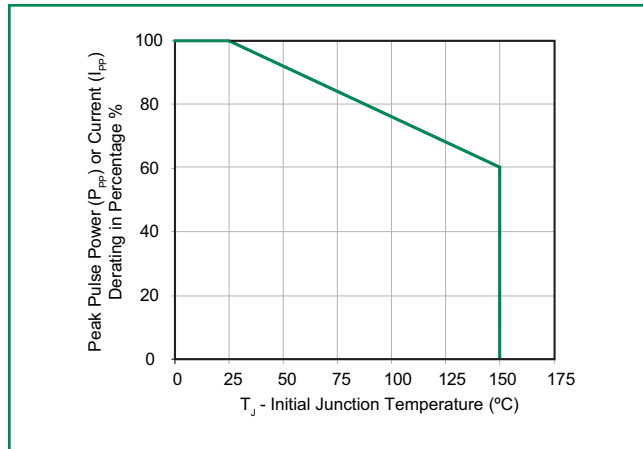

Figure 3 - Pulse Waveform

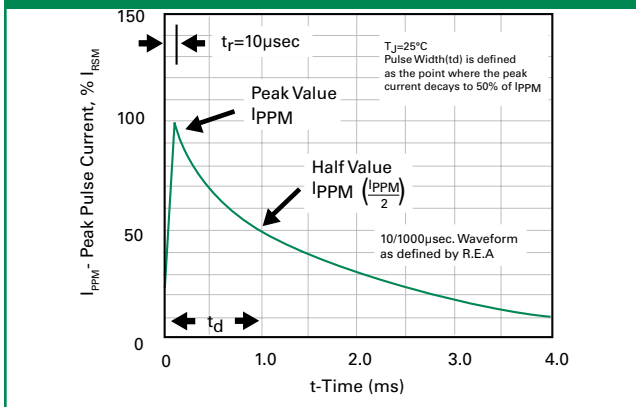
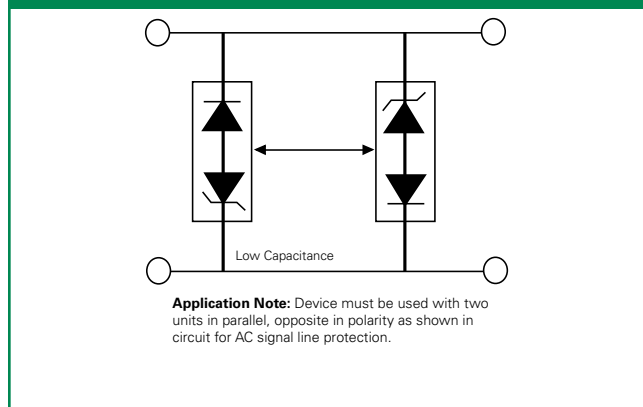
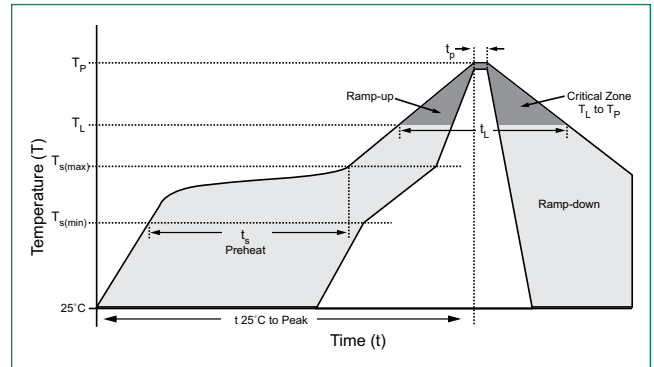

Figure 4 - AC Line Protection Application



Soldering Parameters

Reflow Condition		Lead-free assembly
Pre Heat	- Temperature Min ($T_{s(min)}$)	150°C
	- Temperature Max ($T_{s(max)}$)	200°C
	- Time (min to max) (t_s)	60 – 180 secs
Average ramp up rate (Liquidus Temp (T_A) to peak)		3°C/second max
$T_{s(max)}$ to T_A - Ramp-up Rate		3°C/second max
Reflow	- Temperature (T_A) (Liquidus)	217°C
	- Time (min to max) (t_s)	60 – 150 seconds
Peak Temperature (T_p)		260 ^{+0/-5} °C
Time within 5°C of actual peak Temperature (t_p)		20 – 40 seconds
Ramp-down Rate		6°C/second max
Time 25°C to peak Temperature (T_p)		8 minutes Max.
Do not exceed		260°C



Flow/Wave Soldering (Solder Dipping)

Peak Temperature :	265°C
Dipping Time :	10 seconds
Soldering :	1 time

Physical Specifications

Weight	0.003oz., 0.093g
Case	JEDEC DO-214AA molded plastic body over glass passivated junction.
Polarity	Color band denotes cathode except Bidirectional
Terminal	Matte Tin-plated leads. Solderable per JESD22-B102.

Environmental Specifications

High Temp. Storage	JESD22-A103
HTRB	JESD22-A108
Temperature Cycling	JESD22-A104
MSL	JEDEC-J-STD-020, Level 1
H3TRB	JESD22-A101
RSH	JESD22-A111

Dimensions

DO-214AA (SMB J-Bend)

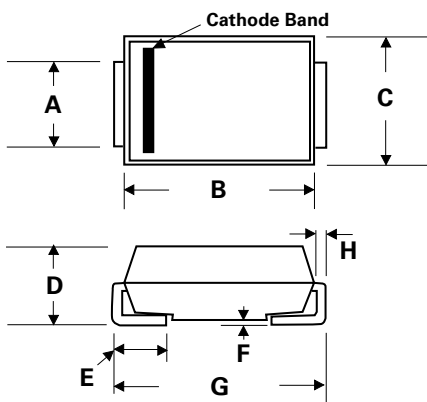

Dimensions	Inches		Millimeters	
	Min	Max	Min	Max
A	0.077	0.086	1.950	2.200
B	0.160	0.180	4.060	4.570
C	0.130	0.155	3.300	3.940
D	0.084	0.096	2.130	2.440
E	0.030	0.060	0.760	1.520
F	-	0.008	-	0.203
G	0.205	0.220	5.210	5.590
H	0.006	0.012	0.152	0.305

Part Numbering System

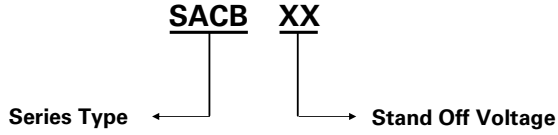

Part Marking System

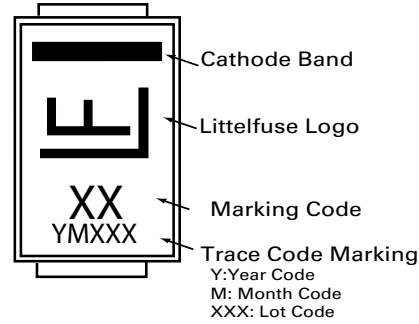

Packaging

Part number	Component Package	Quantity	Packaging Option	Packaging Specification
SACBXX	DO-214AA	3000	Tape & Reel - 12mm tape/13" reel	EIA STD RS-481

Schematic

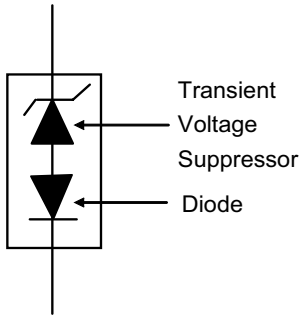

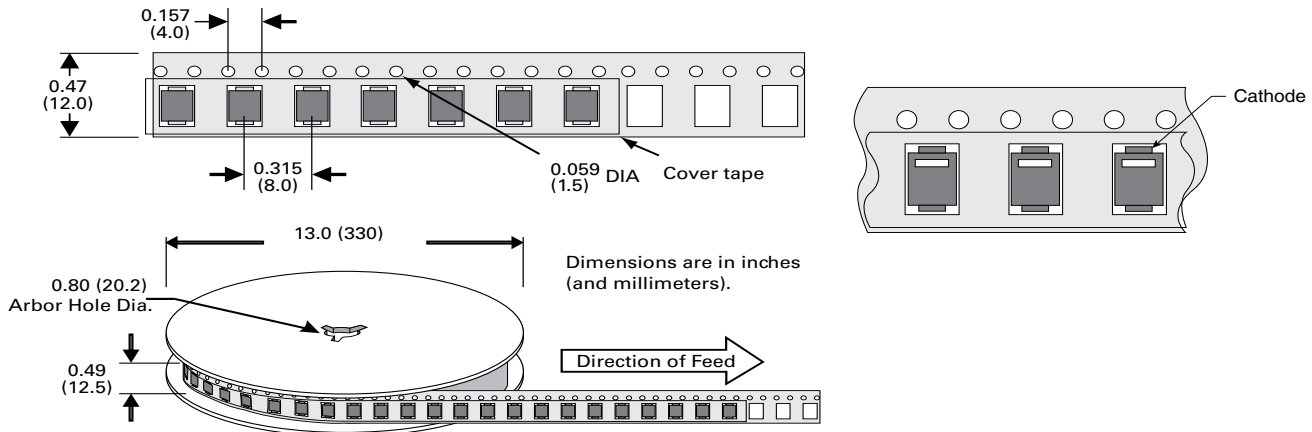

Tape and Reel Specification



Looking for pricing, stock, or lifecycle information?

Click below to explore more details on WIN SOURCE:

-  [View SACB18 on WIN SOURCE](#)
-  [Littelfuse Inc. Information](#)

Optimize Your Supply Chain with WIN SOURCE Solutions

-  Global Sourcing Solution
-  Obsolete Management
-  Cost Control Management
-  Shortage Management
-  Alternative Solution
-  Excess Inventory Management