

SMA6J Series



Agency Approvals	
Agency	Agency File Number
	E230531

Maximum Ratings and Thermal Characteristics (T_A = 25°C unless otherwise noted)

Parameter	Symbol	Value	Unit
Peak Pulse Power Dissipation by 10/1000µs Waveform (Fig.2) (Note 1), (Note 2)	P _{PPM}	600	W
Power Dissipation on Infinite Heat Sink at T _L = 50°C	P _D	3.3	W
Peak Forward Surge Current, 8.3ms Single Half Sine Wave (Note 3)	I _{FSM}	60	A
Maximum Instantaneous Forward Voltage at 25A for Unidirectional Only	V _F	3.5	V
Operating Temperature Range	T _J	-65 to 150	°C
Storage Temperature Range	T _{STG}	-65 to 175	°C
Typical Thermal Resistance Junction to Lead	R _{θJL}	30	°C/W
Typical Thermal Resistance Junction to Ambient	R _{θJA}	120	°C/W

- Notes:**
1. Non-repetitive current pulse, per Fig.4 and derated above T_J (initial) = 25°C per Fig. 3.
 2. Mounted on 5.0x5.0mm copper pad to each terminal.
 3. Measured on 8.3ms single half sine wave or equivalent square wave for unidirectional component only.

Functional Diagram

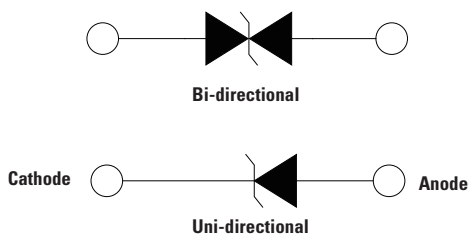

Description

The SMA6J series is designed specifically to protect sensitive electronic equipment from voltage transients induced by lightning and other transient voltage events.

Features

- Small DO-214AC SMT footprint for minimal board space requirement
- Typical failure mode is a short circuit condition for current events exceeding component rating
- Whisker test is conducted based on JEDEC JESD201A per its table 4a and 4c
- IEC 61000-4-2 ESD 30kV(Air), 30kV (Contact)
- ESD protection of data lines in accordance with IEC 61000-4-2
- Built-in strain relief
- Glass passivated junction
- Low inductance
- Excellent clamping capability
- 600W peak pulsepower capability at 10/1000µs waveform, repetition rate (duty cycle): 0.01 %
- Fast response time: typically less than 1.0ps from 0 Volts to V_{BR} min
- Typical I_R < 1µA when V_{BR} min > 12 V
- High temperature reflow soldering guaranteed: 260°C/30sec
- V_{BR} @ T_J = V_{BR} @ 25°C × (1 + α T × (T_J - 25)) (α T: Temperature Coefficient, typical value is 0.1%)
- UL Recognized compound meeting flammability rating V-0
- Meet MSL level1, per J-STD-020, lead-frame maximum peak of 260°C
- Matte tin lead-free plated
- Pb-free E3 means 2nd level interconnect is Pb-free and the terminal finish material is tin(Sn) (IPC/JEDEC J-STD-609A.01)

Applications

TVS components are ideal for the protection of I/O Interfaces, V_{CC} bus and other vulnerable circuits used in Telecom, Computer, Industrial and Consumer electronic applications.

Electrical Characteristics (T_A=25°C unless otherwise noted)

Part Number (Uni)	Part Number (Bi)	Marking		Reverse Stand off Voltage V _R (Volts)	Breakdown Voltage V _{BR} (Volts) @ I _T		Test Current I _T (mA)	Maximum Clamping Voltage V _C @ I _{PP} (V)	Maximum Peak Pulse Current I _{PP} (A)	Maximum Reverse Leakage I _R @ V _R (µA)	Agency Recognition 
		UNI	BI		MIN	MAX					
SMA6J5.0A	SMA6J5.0CA	6BA	6VVE	5	6.40	700	10	9.2	66.0	800	X
SMA6J6.0A	SMA6J6.0CA	6AG	6VWG	6	6.67	737	10	10.3	61.0	800	X
SMA6J6.5A	SMA6J6.5CA	6AK	6VWK	6.5	7.22	798	10	11.2	56.0	500	X
SMA6J7.0A	SMA6J7.0CA	6AM	6VWM	7	7.78	8.60	10	12.0	50.0	200	X
SMA6J7.5A	SMA6J7.5CA	6AP	6VWP	7.5	8.33	9.21	1	12.9	46.5	100	X
SMA6J8.0A	SMA6J8.0CA	6AR	6VWR	8	8.89	9.83	1	13.6	44.1	50	X
SMA6J8.5A	SMA6J8.5CA	6AT	6VWT	8.5	9.44	10.40	1	14.4	41.7	20	X
SMA6J9.0A	SMA6J9.0CA	6AV	6VWV	9	10.0	11.1	1	15.4	39.0	10	X
SMA6J10A	SMA6J10CA	6AX	6VWX	10	11.1	12.3	1	17.0	37.0	5	X
SMA6J11A	SMA6J11CA	6AZ	6VWZ	11	12.2	13.5	1	18.2	33.0	1	X
SMA6J12A	SMA6J12CA	6BE	6XE	12	13.3	14.7	1	19.9	31.0	1	X
SMA6J13A	SMA6J13CA	6BG	6XG	13	14.4	15.9	1	21.5	29.0	1	X
SMA6J14A	SMA6J14CA	6BK	6XK	14	15.6	17.2	1	23.2	25.8	1	X
SMA6J15A	SMA6J15CA	6BM	6XM	15	16.7	18.5	1	24.4	25.1	1	X
SMA6J16A	SMA6J16CA	6BP	6XP	16	17.8	19.7	1	26.0	23.1	1	X
SMA6J17A	SMA6J17CA	6BR	6XR	17	18.9	20.9	1	27.6	22.6	1	X
SMA6J18A	SMA6J18CA	6BT	6XT	18	20.0	22.1	1	29.2	21.5	1	X
SMA6J20A	SMA6J20CA	6BV	6XV	20	22.2	24.5	1	32.4	19.4	1	X
SMA6J22A	SMA6J22CA	6BX	6XX	22	24.4	26.9	1	35.5	17.0	1	X
SMA6J24A	SMA6J24CA	6BZ	6XZ	24	26.7	29.5	1	38.9	16.0	1	X
SMA6J26A	SMA6J26CA	6CE	6YE	26	28.9	31.9	1	42.1	14.9	1	X
SMA6J28A	SMA6J28CA	6CG	6YG	28	31.1	34.4	1	45.4	13.8	1	X
SMA6J30A	SMA6J30CA	6CK	6YK	30	33.3	36.8	1	48.4	12.5	1	X
SMA6J33A	SMA6J33CA	6CM	6YM	33	36.7	40.6	1	53.3	11.8	1	X
SMA6J36A	SMA6J36CA	6CP	6YP	36	40.0	44.2	1	58.1	10.4	1	X
SMA6J40A	SMA6J40CA	6CR	6YR	40	44.4	49.1	1	64.5	9.7	1	X
SMA6J43A	SMA6J43CA	6CT	6YT	43	47.8	52.8	1	69.4	8.7	1	X
SMA6J45A	SMA6J45CA	6CV	6YV	45	50.0	55.3	1	72.7	8.3	1	X
SMA6J48A	SMA6J48CA	6CX	6YX	48	53.3	58.9	1	77.4	8.1	1	X
SMA6J51A	SMA6J51CA	6CZ	6YZ	51	56.7	62.7	1	82.4	7.4	1	X
SMA6J54A	SMA6J54CA	6RE	6ZE	54	60.0	66.3	1	87.1	6.9	1	X
SMA6J58A	SMA6J58CA	6RG	6ZG	58	64.4	71.2	1	93.6	6.7	1	X
SMA6J60A	SMA6J60CA	6RK	6ZK	60	66.7	73.7	1	96.8	6.2	1	X
SMA6J64A	SMA6J64CA	6RM	6ZM	64	71.1	78.6	1	103	5.9	1	X
SMA6J70A	SMA6J70CA	6RP	6ZP	70	77.8	86.0	1	113	5.5	1	X
SMA6J75A	SMA6J75CA	6RR	6ZR	75	83.3	92.1	1	121	5.0	1	X
SMA6J78A	SMA6J78CA	6RT	6ZT	78	86.7	95.8	1	126	4.8	1	X
SMA6J85A	SMA6J85CA	6RV	6ZV	85	94.4	104	1	137	4.6	1	X
SMA6J90A	SMA6J90CA	6RX	6ZX	90	100	111	1	146	4.2	1	X
SMA6J100A	-	6RZ	-	100	111	123	1	162	3.8	1	X
SMA6J110A	-	6SE	-	110	122	135	1	177	3.5	1	X
SMA6J120A	-	6SG	-	120	133	147	1	193	3.2	1	X
SMA6J130A	-	6SK	-	130	144	159	1	209	2.9	1	X

For bidirectional type having V_R of 10 volts and less, the I_R limit is double.

I-V Curve Characteristics



- P_{PPM} Peak Pulse Power Dissipation** – Max power dissipation
- V_r Stand-off Voltage** – Maximum voltage that can be applied to the TVS without operation
- V_{BR} Breakdown Voltage** – Maximum voltage that flows through the TVS at a specified test current (I_r)
- V_c Clamping Voltage** – Peak voltage measured across the TVS at a specified I_{PPM} (peak impulse current @ 10/1000)
- I_r Reverse Leakage Current** – Current measured at V_r
- V_f Forward Voltage Drop for Uni-directional**

Ratings and Characteristic Curves ($T_A=25^\circ\text{C}$ unless otherwise noted)

Figure 1 - TVS Transients Clamping Waveform



Figure 2 - Peak Pulse Power Rating Curve



Ratings and Characteristic Curves ($T_A=25^\circ\text{C}$ unless otherwise noted) (Continued)

Figure 3 - Peak Pulse Power Derating Curve

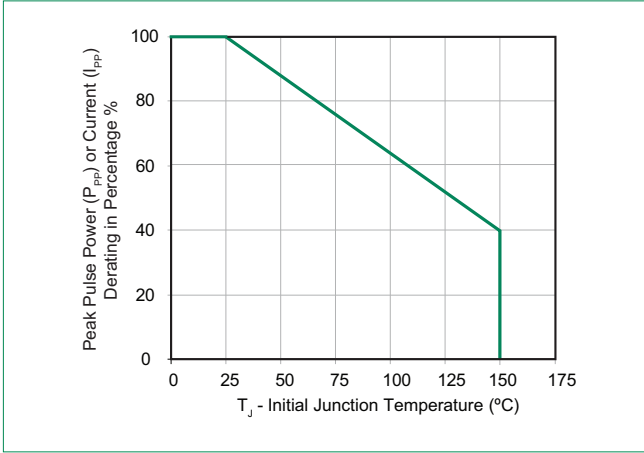

Figure 4 - Pulse Waveform

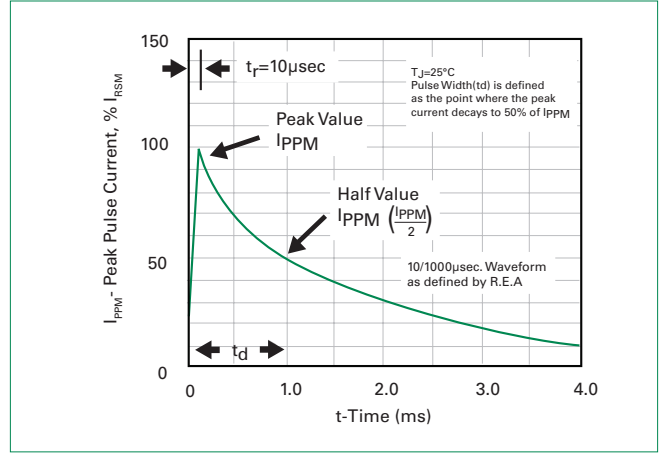

Figure 5 - Typical Transient Thermal Impedance

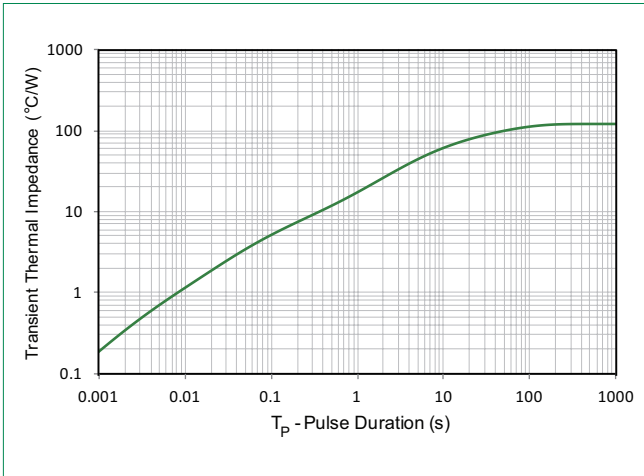

Figure 6 - Peak Forward Voltage Drop vs Peak Forward Current (typical values)

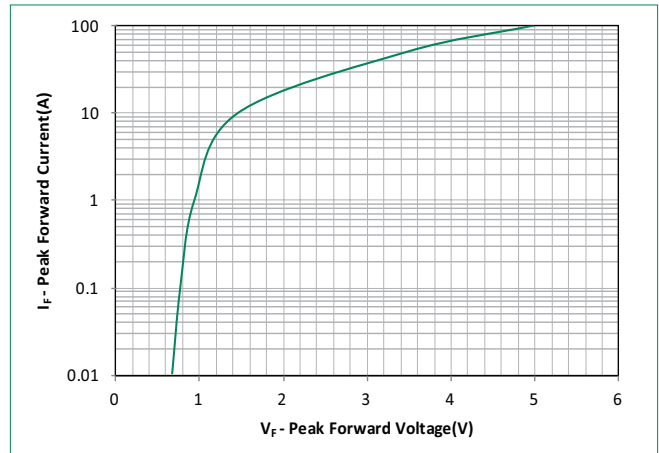

Figure 7 - Maximum Non-Repetitive Forward Surge Current Uni-Directional Only

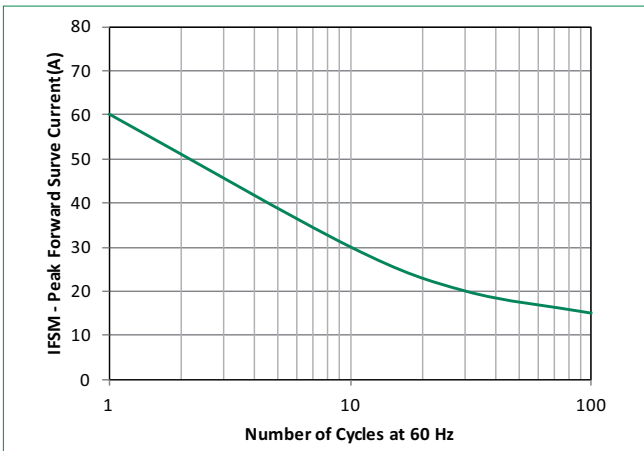
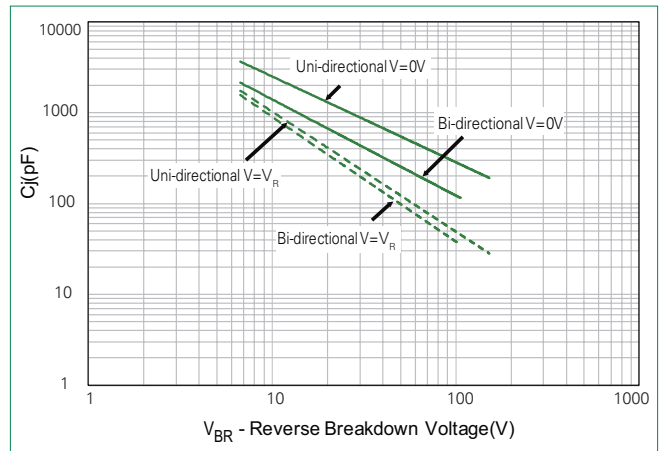

Figure 8 - Typical Junction Capacitance



Soldering Parameters

Reflow Condition		Lead-free assembly
Pre Heat	- Temperature Min ($T_{s(min)}$)	150°C
	- Temperature Max ($T_{s(max)}$)	200°C
	- Time (min to max) (t_s)	60 – 120 secs
Average ramp up rate (Liquidus Temp (T_L) to peak)		3°C/second max
$T_{s(max)}$ to T_L - Ramp-up Rate		3°C/second max
Reflow	- Temperature (T_L) (Liquidus)	217°C
	- Time (min to max) (t_L)	60 – 150 seconds
Peak Temperature (T_p)		260 ^{+0/-5} °C
Time within 5°C of actual peak Temperature (t_p)		30 seconds max
Ramp-down Rate		6°C/second max
Time 25°C to peak Temperature (T_p)		8 minutes Max.
Do not exceed		260°C



Physical Specifications

Weight	0.002 ounce, 0.061 gram
Case	JEDEC DO-214AC Molded Plastic over glass passivated junction
Polarity	Color band denotes cathode except Bipolar
Terminal	Matte Tin-plated leads, Solderable per JESD22-B102

Environmental Specifications

High Temp. Storage	JESD22-A103
HTRB	JESD22-A108
Temperature Cycling	JESD22-A104
MSL	JEDEC-J-STD-020, Level 1
H3TRB	JESD22-A101
RSH	JESD22-A111

Dimensions



Dimensions	Inches		Millimeters	
	Min	Max	Min	Max
A	0.049	0.065	1.250	1.650
B	0.157	0.181	3.990	4.600
C	0.095	0.110	2.400	2.790
D	0.075	0.090	1.900	2.290
E	0.030	0.060	0.780	1.520
F	-	0.008	-	0.203
G	0.189	0.208	4.800	5.280
H	0.006	0.012	0.152	0.305
I	0.070	-	1.800	-
J	0.082	-	2.100	-
K	-	0.090	-	2.300
L	0.082	-	2.100	-

Part Numbering System



Part Marking System



Packaging

Part number	Component Package	Quantity	Packaging Option	Packaging Specification
SMA6JxxXX	DO-214AC	5000	Tape & Reel - 12mm tape/13" reel	EIA RS-481

Tape and Reel Specification



Looking for pricing, stock, or lifecycle information?

Click below to explore more details on WIN SOURCE:

 [View SMA6J43A on WIN SOURCE](#)

 [Littelfuse Inc. Information](#)

Optimize Your Supply Chain with WIN SOURCE Solutions

-  Global Sourcing Solution
-  Obsolete Management
-  Cost Control Management
-  Shortage Management
-  Alternative Solution
-  Excess Inventory Management