



**THE DATASHEET OF
SMBJ58CA-HR**



SMBJ-HR Series



Agency Approvals

Agency	Agency File Number
	E230531

Maximum Ratings and Thermal Characteristics (T_A=25°C unless otherwise noted)

Parameter	Symbol	Value	Unit
Peak Pulse Power Dissipation at T _A =25°C by 10/1000µs Waveform (Fig.2)(Note 1), (Note 2)	P _{PPM}	600	W
Power Dissipation on Infinite Heat Sink at T _A =50°C	P _{M(AV)}	5.0	W
Peak Forward Surge Current, 8.3ms Single Half Sine Wave (Note 3)	I _{FSM}	100	A
Maximum Instantaneous Forward Voltage at 50A for Unidirectional Only	V _F	3.5V	V
Operating Junction and Storage Temperature Range	T _J , T _{STG}	-65 to 150	°C
Typical Thermal Resistance Junction to Lead	R _{θJL}	20	°C/W
Typical Thermal Resistance Junction to Ambient	R _{θJA}	100	°C/W

- Notes:**
 1. Non-repetitive current pulse per Fig. 4 and derated above T_A = 25°C per Fig. 3.
 2. Mounted on copper pad area of 0.2x0.2" (5.0 x 5.0mm) to each terminal.
 3. Measured on 8.3ms single half sine wave or equivalent square wave for unidirectional device only, duty cycle=4 per minute maximum.

Functional Diagram



Description

The SMBJ-HR High Reliability series is designed specifically to protect sensitive electronic equipment from voltage transients induced by lightning and other transient voltage events.

Features

- 600W peak pulse power capability at 10/1000µs waveform, repetition rate (duty cycles):0.01%
- Excellent clamping capability
- Low incremental surge resistance
- Typical I_R less than 1µA above 12V
- For surface mounted applications to optimize board space
- Low profile package
- Typical failure mode is short from over-specified voltage or current
- Whisker test is conducted based on JEDEC JESD201A per its table 4a and 4c
- IEC 61000-4-2 ESD 15kV(Air), 8kV (Contact)
- ESD protection of data lines in accordance with IEC 61000-4-2
- EFT protection of data lines in accordance with IEC 61000-4-4
- Built-in strain relief
- Fast response time: typically less than 1.0ps from 0V to BV min
- V_{BR} @ T_J = V_{BR} @ 25°C x (1 + αT x (T_J - 25)) (αT: Temperature Coefficient, typical value is 0.1%)
- Glass passivated chip junction
- High temperature soldering guaranteed: 260°C/40 seconds at terminals
- Plastic package is flammability rated V-0 per UL 94
- Meet MSL level1, per J-STD-020, LF maximum peak of 260°C.
- Matte tin lead-free plated
- Halogen free and RoHS compliant
- Pb-free E3 means 2nd level interconnect is Pb-free and the terminal finish material is tin(Sn) (IPC/JEDEC J-STD-609A.01)
- UL Recognized to ANSI/UL 497B: Protectors for Data Communications and Fire-Alarm Circuits.

Applications

TVS Components are ideal for the protection of I/O Interfaces, V_{CC} bus and other vulnerable circuits used in Telecom, Computer, Industrial and Consumer electronic applications.

Electrical Characteristics (T_a=25°C unless otherwise noted)

Part Number (Uni)	Part Number (Bi)	Marking		Reverse Stand off Voltage V _R (Volts)	Breakdown Voltage V _{BR} (Volts) @ I _T		Test Current I _T (mA)	Maximum Clamping Voltage V _C @ I _{PP} (V)	Maximum Peak Pulse Current I _{PP} (A)	Maximum Reverse Leakage I _R @ V _R (µA)	Agency Approval 
		UNI	BI		MIN	MAX					
SMBJ5.0A-HR	SMBJ5.0CA-HR	KE	AE	5.0	6.40	7.00	10	9.2	65.3	800	X
SMBJ6.0A-HR	SMBJ6.0CA-HR	KG	AG	6.0	6.67	7.37	10	10.3	58.3	800	X
SMBJ6.5A-HR	SMBJ6.5CA-HR	KK	AK	6.5	7.22	7.98	10	11.2	53.6	500	X
SMBJ7.0A-HR	SMBJ7.0CA-HR	KM	AM	7.0	7.78	8.60	10	12.0	50.0	200	X
SMBJ7.5A-HR	SMBJ7.5CA-HR	KP	AP	7.5	8.33	9.21	1	12.9	46.6	100	X
SMBJ8.0A-HR	SMBJ8.0CA-HR	KR	AR	8.0	8.89	9.83	1	13.6	44.2	50	X
SMBJ8.5A-HR	SMBJ8.5CA-HR	KT	AT	8.5	9.44	10.40	1	14.4	41.7	20	X
SMBJ9.0A-HR	SMBJ9.0CA-HR	KV	AV	9.0	10.00	11.10	1	15.4	39.0	10	X
SMBJ10A-HR	SMBJ10CA-HR	KX	AX	10.0	11.10	12.30	1	17.0	35.3	5	X
SMBJ11A-HR	SMBJ11CA-HR	KZ	AZ	11.0	12.20	13.50	1	18.2	33.0	1	X
SMBJ12A-HR	SMBJ12CA-HR	LE	BE	12.0	13.30	14.70	1	19.9	30.2	1	X
SMBJ13A-HR	SMBJ13CA-HR	LG	BG	13.0	14.40	15.90	1	21.5	28.0	1	X
SMBJ14A-HR	SMBJ14CA-HR	LK	BK	14.0	15.60	17.20	1	23.2	25.9	1	X
SMBJ15A-HR	SMBJ15CA-HR	LM	BM	15.0	16.70	18.50	1	24.4	24.6	1	X
SMBJ16A-HR	SMBJ16CA-HR	LP	BP	16.0	17.80	19.70	1	26.0	23.1	1	X
SMBJ17A-HR	SMBJ17CA-HR	LR	BR	17.0	18.90	20.90	1	27.6	21.8	1	X
SMBJ18A-HR	SMBJ18CA-HR	LT	BT	18.0	20.00	22.10	1	29.2	20.6	1	X
SMBJ20A-HR	SMBJ20CA-HR	LV	BV	20.0	22.20	24.50	1	32.4	18.6	1	X
SMBJ22A-HR	SMBJ22CA-HR	LX	BX	22.0	24.40	26.90	1	35.5	16.9	1	X
SMBJ24A-HR	SMBJ24CA-HR	LZ	BZ	24.0	26.70	29.50	1	38.9	15.5	1	X
SMBJ26A-HR	SMBJ26CA-HR	ME	CE	26.0	28.90	31.90	1	42.1	14.3	1	X
SMBJ28A-HR	SMBJ28CA-HR	MG	CG	28.0	31.10	34.40	1	45.4	13.3	1	X
SMBJ30A-HR	SMBJ30CA-HR	MK	CK	30.0	33.30	36.80	1	48.4	12.4	1	X
SMBJ33A-HR	SMBJ33CA-HR	MM	CM	33.0	36.70	40.60	1	53.3	11.3	1	X
SMBJ36A-HR	SMBJ36CA-HR	MP	CP	36.0	40.00	44.20	1	58.1	10.4	1	X
SMBJ40A-HR	SMBJ40CA-HR	MR	CR	40.0	44.40	49.10	1	64.5	9.3	1	X
SMBJ43A-HR	SMBJ43CA-HR	MT	CT	43.0	47.80	52.80	1	69.4	8.7	1	X
SMBJ45A-HR	SMBJ45CA-HR	MV	CV	45.0	50.00	55.30	1	72.7	8.3	1	X
SMBJ48A-HR	SMBJ48CA-HR	MX	CX	48.0	53.30	58.90	1	77.4	7.8	1	X
SMBJ51A-HR	SMBJ51CA-HR	MZ	CZ	51.0	56.70	62.70	1	82.4	7.3	1	X
SMBJ54A-HR	SMBJ54CA-HR	NE	DE	54.0	60.00	66.30	1	87.1	6.9	1	X
SMBJ58A-HR	SMBJ58CA-HR	NG	DG	58.0	64.40	71.20	1	93.6	6.5	1	X
SMBJ60A-HR	SMBJ60CA-HR	NK	DK	60.0	66.70	73.70	1	96.8	6.2	1	X
SMBJ64A-HR	SMBJ64CA-HR	NM	DM	64.0	71.10	78.60	1	103.0	5.9	1	X
SMBJ70A-HR	SMBJ70CA-HR	NP	DP	70.0	77.80	86.00	1	113.0	5.3	1	X
SMBJ75A-HR	SMBJ75CA-HR	NR	DR	75.0	83.30	92.10	1	121.0	5.0	1	X
SMBJ78A-HR	SMBJ78CA-HR	NT	DT	78.0	86.70	95.80	1	126.0	4.8	1	X
SMBJ85A-HR	SMBJ85CA-HR	NV	DV	85.0	94.40	104.00	1	137.0	4.4	1	X
-	SMBJ90CA-HR	-	DX	90.0	100.00	111.00	1	146.0	4.1	1	X
-	SMBJ100CA-HR	-	DZ	100.0	111.00	123.00	1	162.0	3.7	1	X
-	SMBJ110CA-HR	-	EE	110.0	122.00	135.00	1	177.0	3.4	1	X
-	SMBJ120CA-HR	-	EG	120.0	133.00	147.00	1	193.0	3.1	1	X
-	SMBJ130CA-HR	-	EK	130.0	144.00	159.00	1	209.0	2.9	1	X
-	SMBJ150CA-HR	-	EM	150.0	167.00	185.00	1	243.0	2.5	1	X
-	SMBJ160CA-HR	-	EP	160.0	178.00	197.00	1	259.0	2.3	1	X
-	SMBJ170CA-HR	-	ER	170.0	189.00	209.00	1	275.0	2.2	1	X

Note:

- Each lot of parts will pass group B test requirement.

Screen Process

100% Vision Inspection	MIL-STD-750 method 2074
100% High Temperature Storage Life (168hrs,175°C)	MIL-STD-750 method 1031
100% X-RAY inspection	MIL-STD-750 method 2076
100% Temperature Cycle Test (-55 to150°C, 20 cycles, dwell time 15 min)	MIL-STD-750 method 1051
100% Reflow (2x)	JEDEC J-STD-020
100% Surge Test (2x)	MIL-STD-750 method 4066
100% HTRB 150°C Bias=VR(80% breakdown voltage, 96hrs, and each direction 96hrs for Bi-directional products)	MIL-STD-750 method 1038
Final Electrical Test(100% 3 sigma limit, 100% dynamic test and PAT limit)	MIL-STD-750 method 4016.4021.4011

Note: Up-screen program can be specified by customer's request via contacting Littelfuse service

Group B Test Requirement

Screen	Method	Condition	Requirement
Surge test	10/1000 μ s Peak Pulse Waveform	Maximum clamping Voltage (V_C) @ Peak Pulse Current (I_{pp})	Sample Size 45 perform 10x Accept 0 failures
Burn - In (HTRB)	MIL -STD-750, Method 1038.5	Applied voltage 100% V_R @150°C	Sample size 45 340 hours (680 hours for bi-direction products, each direction 340 hours) Accept 0 failures
Electrical test	-	I_R @ V_R , $V_{(BR)}$ @ I_T	Sample size 45 Accept 0 failures

I-V Curve Characteristics

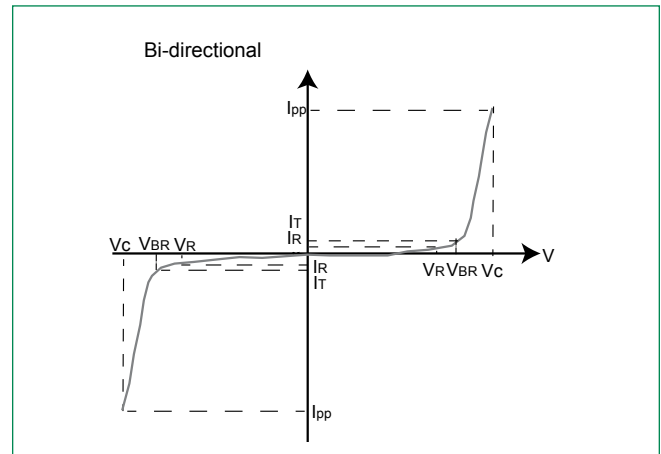
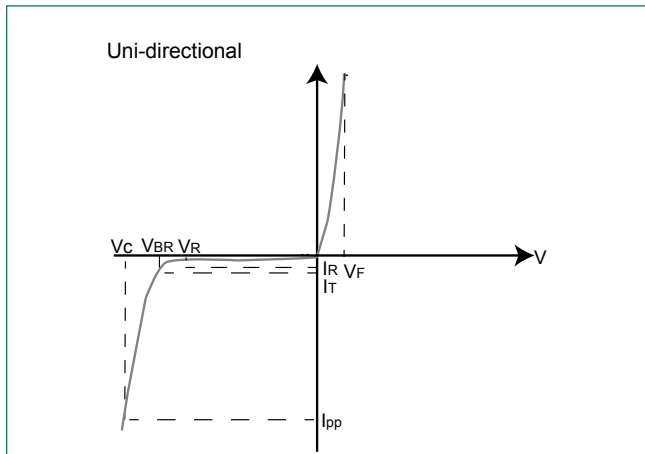

- P_{PPM} Peak Pulse Power Dissipation** – Max power dissipation
- V_R Stand-off Voltage** – Maximum voltage that can be applied to the TVS without operation
- V_{BR} Breakdown Voltage** – Maximum voltage that flows though the TVS at a specified test current (I_T)
- V_C Clamping Voltage** – Peak voltage measured across the suppressor at a specified I_{ppm} (peak impulse current)
- I_R Reverse Leakage Current** – Current measured at V_R
- V_F Forward Voltage Drop for Uni-directional**

Ratings and Characteristic Curves ($T_A=25^\circ\text{C}$ unless otherwise noted)

Figure 1 - TVS Transients Clamping Waveform

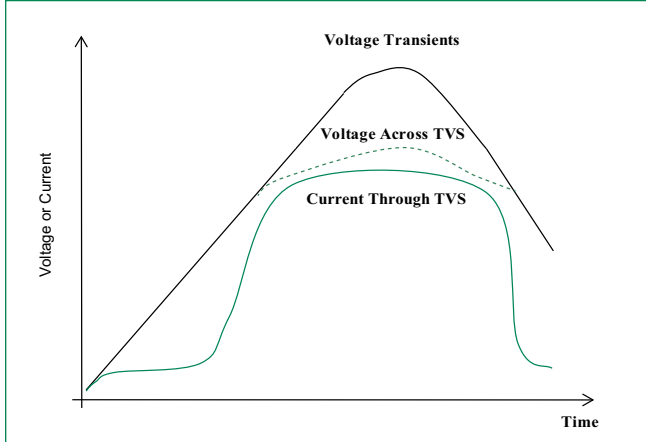

Figure 2 - Peak Pulse Power Rating

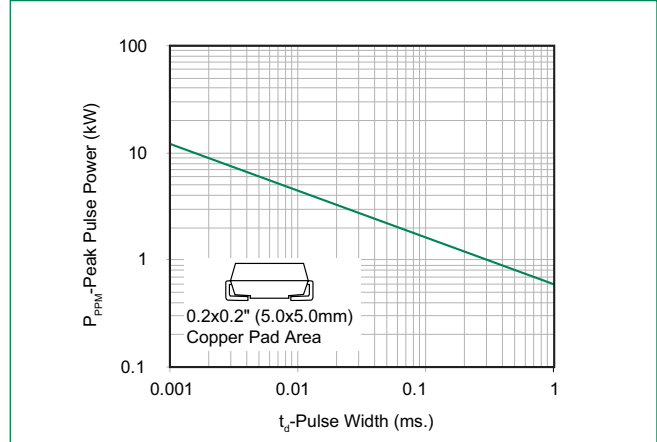

Figure 3 - Pulse Derating Curve



Figure 4 - Pulse Waveform



Figure 5 - Typical Junction Capacitance



Figure 6 - Steady State Power Dissipation Derating Curve



Figure 7 - Maximum Non-Repetitive Peak Forward Surge Current Uni-Directional Only

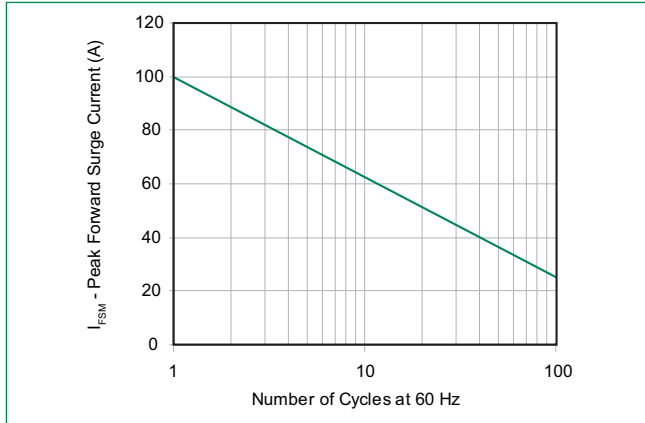

Soldering Parameters

Reflow Condition		Lead-free assembly
Pre Heat	- Temperature Min ($T_{s(min)}$)	150°C
	- Temperature Max ($T_{s(max)}$)	200°C
	- Time (min to max) (t_s)	60 – 180 secs
Average ramp up rate (Liquidus Temp (T_L) to peak)		3°C/second max
$T_{s(max)}$ to T_L - Ramp-up Rate		3°C/second max
Reflow	- Temperature (T_L) (Liquidus)	217°C
	- Time (min to max) (t_s)	60 – 150 seconds
Peak Temperature (T_p)		260 ^{+0/-5} °C
Time within 5°C of actual peak Temperature (t_p)		20 – 40 seconds
Ramp-down Rate		6°C/second max
Time 25°C to peak Temperature (T_p)		8 minutes Max.
Do not exceed		260°C



Physical Specifications

Weight	0.003 ounce, 0.093 grams
Case	JEDEC DO214AA. Molded plastic body over glass passivated junction
Polarity	Color band denotes cathode except Bidirectional
Terminal	Matte Tin-plated leads, Solderable per JESD22-B102

Environmental Specifications

High Temp. Storage	JESD22-A103
HTRB	JESD22-A108
Temperature Cycling	JESD22-A104
MSL	JEDEC-J-STD-020, Level 1
H3TRB	JESD22-A101
RSH	JESD22-A111

Dimensions



Dimensions	Inches		Millimeters	
	Min	Max	Min	Max
A	0.077	0.086	1.950	2.200
B	0.160	0.180	4.060	4.570
C	0.130	0.155	3.300	3.940
D	0.084	0.096	2.130	2.440
E	0.030	0.060	0.760	1.520
F	-	0.008	-	0.203
G	0.205	0.220	5.210	5.590
H	0.006	0.012	0.152	0.305
I	0.089	-	2.260	-
J	0.085	-	2.160	-
K	-	0.107	-	2.740
L	0.085	-	2.160	-

Part Numbering System

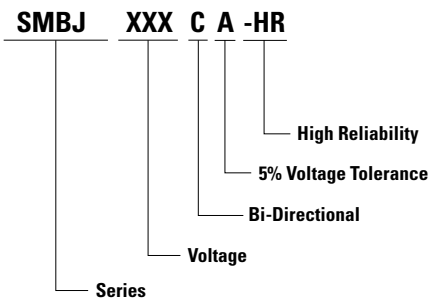

Part Marking System

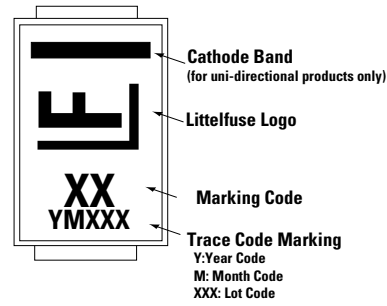

Packaging

Part number	Component Package	Quantity	Packaging Option	Packaging Specification
SMBJxxxXX-HR	DO-214AA	3000	Tape & Reel - 12mm tape/13" reel	EIA STD RS-481

Tape and Reel Specification



Disclaimer Notice - Information furnished is believed to be accurate and reliable. However, users should independently evaluate the suitability of and test each product selected for their own applications. Littelfuse products are not designed for, and may not be used in, all applications. Read complete Disclaimer Notice at: www.littelfuse.com/disclaimer-electronics.

Looking for pricing, stock, or lifecycle information?

Click below to explore more details on WIN SOURCE:

 [View SMBJ58CA-HR on WIN SOURCE](#)

 [Littelfuse Inc. Information](#)

Optimize Your Supply Chain with WIN SOURCE Solutions

-  Global Sourcing Solution
-  Obsolete Management
-  Cost Control Management
-  Shortage Management
-  Alternative Solution
-  Excess Inventory Management