



THE DATASHEET OF SMCG15CA-HR



SMCG-HR Series



Agency Approvals

Agency	Agency File Number
	E230531

**Maximum Ratings and Thermal Characteristics
(T_A=25°C unless otherwise noted)**

Parameter	Symbol	Value	Unit
Peak Pulse Power Dissipation by 10/1000µs waveform (Fig.2)(Note 1), (Note 2)	P _{PPM}	1500	W
Power Dissipation on infinite heat sink at T _A =50°C	P _{M(AV)}	6.5	W
Peak Forward Surge Current, 8.3ms Single Half Sine Wave (Note 3)	I _{FSM}	200	A
Maximum Instantaneous Forward Voltage at 100A for Unidirectional only	V _F	3.5	V
Operating Junction and Storage Temperature Range	T _J , T _{STG}	-65 to 150	°C
Typical Thermal Resistance Junction to Lead	R _{θJL}	15	°C/W
Typical Thermal Resistance Junction to Ambient	R _{θJA}	75	°C/W

- Notes:**
1. Non-repetitive current pulse per Fig. 4 and derated above T_A = 25°C per Fig. 3.
 2. Mounted on copper pad area of 0.31x0.31" (8.0 x 8.0mm) to each terminal.
 3. Measured on 8.3ms single half sine wave or equivalent square wave for unidirectional device only, duty cycle=4 per minute maximum.

Functional Diagram



Description

The SMCG-HR series is designed specifically to protect sensitive electronic equipment from voltage transients induced by lightning and other transient voltage events.

Features

- High-Reliability up-screened for critical applications require higher reliability performance and low infant mortality failures.
- Excellent clamping capability
- Low incremental surge resistance
- Typical I_R less than 1µA above 12V
- For surface mounted applications to optimize board space
- L bend lead forming gives best solderability for Hi reliability application
- Typical failure mode is short from over-specified voltage or current
- Whisker test is conducted based on JEDEC JESD201A per its table 4a and 4c
- IEC-61000-4-2 ESD 30kV(Air), 30kV (Contact)
- ESD protection of data lines in accordance with IEC 61000-4-2
- EFT protection of data lines in accordance with IEC 61000-4-4
- Built-in strain relief
- Fast response time: typically less than 1.0ps from 0V to V_{BR} min
- 1500W peak pulse power capability at 10/1000µs waveform, repetition rate (duty cycles):0.01%
- V_{BR}@T_J= V_{BR}@25°C x (1 + α T x (T_J - 25)) (α T: Temperature Coefficient, typical value is 0.1%)
- Glass passivated chip junction
- High temperature soldering guaranteed: 260°C/10 seconds at terminals
- Meet MSL level1, per J-STD-020, high temperature soldering guaranteed.
- Matte tin lead-free plated
- Halogen free
- RoHS compliant with exemption 7a and 7c-I
- Pb-free E3 means 2nd level interconnect is Pb-free and the terminal finish material is tin(Sn) (IPC/ JEDEC J-STD-609A.01)

Applications

TVS Components are ideal for the protection of I/O Interfaces, V_{CC} bus and other vulnerable circuits used in Telecom, Computer, Industrial and Consumer electronic applications.

Electrical Characteristics

Part Number (Uni)	Part Number (Bi)	Marking		Reverse Stand off Voltage V_R (Volts)	Breakdown Voltage V_{BR} (Volts) @ I_T		Test Current I_T (mA)	Maximum Clamping Voltage V_C @ I_{PP} (V)	Maximum Peak Pulse Current I_{PP} (A)	Maximum Reverse Leakage I_R @ V_R (μ A)	Agency Approval 
		UNI	BI		MIN	MAX					
SMCG5.0A-HR	SMCG5.0CA-HR	GDE	BDE	5.0	6.40	7.00	10	9.2	163.0	800	X
SMCG6.0A-HR	SMCG6.0CA-HR	GDG	BDG	6.0	6.67	7.37	10	10.3	145.7	800	X
SMCG6.5A-HR	SMCG6.5CA-HR	GDK	BDK	6.5	7.22	7.98	10	11.2	134.0	500	X
SMCG7.0A-HR	SMCG7.0CA-HR	GDM	BDM	7.0	7.78	8.60	10	12.0	125.0	200	X
SMCG7.5A-HR	SMCG7.5CA-HR	GDP	BDP	7.5	8.33	9.21	1	12.9	116.3	100	X
SMCG8.0A-HR	SMCG8.0CA-HR	GDR	BDR	8.0	8.89	9.83	1	13.6	110.3	50	X
SMCG8.5A-HR	SMCG8.5CA-HR	GDT	BDT	8.5	9.44	10.40	1	14.4	104.2	20	X
SMCG9.0A-HR	SMCG9.0CA-HR	GDV	BDV	9.0	10.00	11.10	1	15.4	97.4	10	X
SMCG10A-HR	SMCG10CA-HR	GDX	BDX	10.0	11.10	12.30	1	17.0	88.3	5	X
SMCG11A-HR	SMCG11CA-HR	GDZ	BDZ	11.0	12.20	13.50	1	18.2	82.5	1	X
SMCG12A-HR	SMCG12CA-HR	GEE	BEE	12.0	13.30	14.70	1	19.9	75.4	1	X
SMCG13A-HR	SMCG13CA-HR	GEG	BEG	13.0	14.40	15.90	1	21.5	69.8	1	X
SMCG14A-HR	SMCG14CA-HR	GEK	BEK	14.0	15.60	17.20	1	23.2	64.7	1	X
SMCG15A-HR	SMCG15CA-HR	GEM	BEM	15.0	16.70	18.50	1	24.4	61.5	1	X
SMCG16A-HR	SMCG16CA-HR	GEP	BEP	16.0	17.80	19.70	1	26.0	57.7	1	X
SMCG17A-HR	SMCG17CA-HR	GER	BER	17.0	18.90	20.90	1	27.6	54.4	1	X
SMCG18A-HR	SMCG18CA-HR	GET	BET	18.0	20.00	22.10	1	29.2	51.4	1	X
SMCG20A-HR	SMCG20CA-HR	GEV	BEV	20.0	22.20	24.50	1	32.4	46.3	1	X
SMCG22A-HR	SMCG22CA-HR	GEX	BEX	22.0	24.40	26.90	1	35.5	42.3	1	X
SMCG24A-HR	SMCG24CA-HR	GEZ	BEZ	24.0	26.70	29.50	1	38.9	38.6	1	X
SMCG26A-HR	SMCG26CA-HR	GFE	BEF	26.0	28.90	31.90	1	42.1	35.7	1	X
SMCG28A-HR	SMCG28CA-HR	GFG	BFG	28.0	31.10	34.40	1	45.4	33.1	1	X
SMCG30A-HR	SMCG30CA-HR	GFK	BFK	30.0	33.30	36.80	1	48.4	31.0	1	X
SMCG33A-HR	SMCG33CA-HR	GFM	BFM	33.0	36.70	40.60	1	53.3	28.2	1	X
SMCG36A-HR	SMCG36CA-HR	GFP	BFP	36.0	40.00	44.20	1	58.1	25.9	1	X
SMCG40A-HR	SMCG40CA-HR	GFR	BFR	40.0	44.40	49.10	1	64.5	23.3	1	X
SMCG43A-HR	SMCG43CA-HR	GFT	BFT	43.0	47.80	52.80	1	69.4	21.7	1	X
SMCG45A-HR	SMCG45CA-HR	GFV	BFV	45.0	50.00	55.30	1	72.7	20.6	1	X
SMCG48A-HR	SMCG48CA-HR	GFX	BFX	48.0	53.30	58.90	1	77.4	19.4	1	X
SMCG51A-HR	SMCG51CA-HR	GFZ	BFZ	51.0	56.70	62.70	1	82.4	18.2	1	X
SMCG54A-HR	SMCG54CA-HR	GGE	BGE	54.0	60.00	66.30	1	87.1	17.3	1	X
SMCG58A-HR	SMCG58CA-HR	GGG	BGG	58.0	64.40	71.20	1	93.6	16.1	1	X
SMCG60A-HR	SMCG60CA-HR	GGK	BGK	60.0	66.70	73.70	1	96.8	15.5	1	X
SMCG64A-HR	SMCG64CA-HR	GGM	BGM	64.0	71.10	78.60	1	103.0	14.6	1	X
SMCG70A-HR	SMCG70CA-HR	GGP	BGP	70.0	77.80	86.00	1	113.0	13.3	1	X
SMCG75A-HR	SMCG75CA-HR	GGR	BGR	75.0	83.30	92.10	1	121.0	12.4	1	X
SMCG78A-HR	SMCG78CA-HR	GGT	BGT	78.0	86.70	95.80	1	126.0	11.9	1	X
SMCG85A-HR	SMCG85CA-HR	GGV	BGV	85.0	94.40	104.00	1	137.0	11.0	1	X
SMCG90A-HR	SMCG90CA-HR	GGX	BGX	90.0	100.00	111.00	1	146.0	10.3	1	X
SMCG100A-HR	SMCG100CA-HR	GGZ	BGZ	100.0	111.00	123.00	1	162.0	9.3	1	X
SMCG110A-HR	SMCG110CA-HR	GHE	BHE	110.0	122.00	135.00	1	177.0	8.5	1	X
SMCG120A-HR	SMCG120CA-HR	GHG	BHG	120.0	133.00	147.00	1	193.0	7.8	1	X

Screen Process

100% vision inspection	MIL-STD-750 method 2074
100% High Temperature Storage Life (168hrs, 175C°)	MIL-STD-750 method 1031
100% X-RAY inspection	MIL-STD-750 method 2076
100% Temperature cycle test (-55-150C°, 20 cycles, dwell time 15 min)	MIL-STD-750 method 1051
100% Reflow (2x)	JEDEC J-STD-020
100% surge test (2x)	MIL-STD-750 method 4066
100% HTRB(150C°, Bias= V_R (80% breakdown voltage), 96hrs), for Bi-direction products, 96hrs for each direction	MIL-STD-750 method 1038
Final electrical test(100% 3 sigma limit, 100% dynamic test and PAT limit)	MIL-STD-750 method 4016.4021.4011

Note: Up-screen program can be specified by customer's request via contacting Littelfuse service

Group B Test Requirement

Screen	Method	Condition	Requirement
Surge Test	10/1000 μ S Peak Pulse Waveform	Maximum Clamping Voltage (V_C) @ Peak Pulse Current (I_{pp})	Sample Size 45 Perform 10x Accept 0 Failures
Burn - In (HTRB)	MIL - STD - 750, Method 1038.5	Applied Voltage 100% V_R @ 150°C	Sample Size 45 For Unidirectional, 150C°/ V_R /340hours, for Bidirectional, 150C°/ V_R /680hrs(340hours for each direction) Accept 0 Failures
Electrical Tests	–	I_R @ V_R , V_{BR} @ I_T	Sample Size 45 Accept 0 Failures

I-V Curve Characteristics

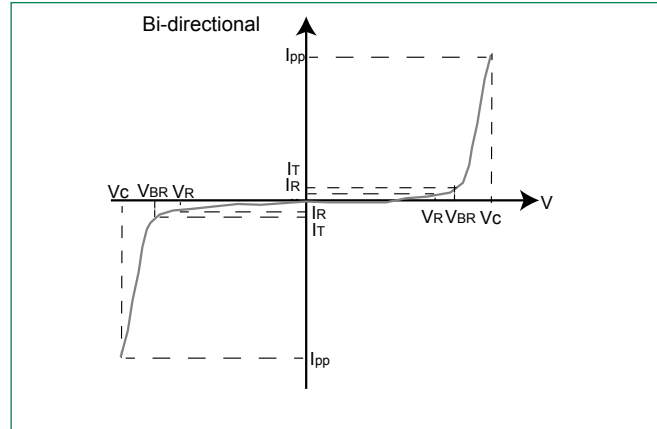
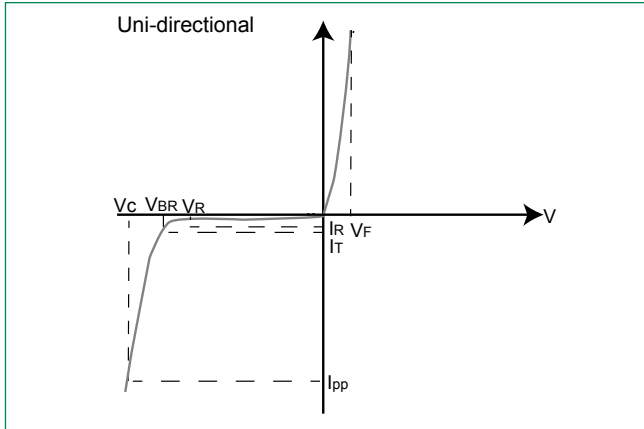

- P_{PPM} Peak Pulse Power Dissipation** -- Max power dissipation
- V_R Stand-off Voltage** -- Maximum voltage that can be applied to the TVS without operation
- V_{BR} Breakdown Voltage** -- Maximum voltage that flows through the TVS at a specified test current (I_T)
- V_C Clamping Voltage** -- Peak voltage measured across the TVS at a specified I_{ppm} (peak impulse current)
- I_R Reverse Leakage Current** -- Current measured at V_R
- V_F Forward Voltage Drop for Uni-directional**

Ratings and Characteristic Curves ($T_A=25^\circ\text{C}$ unless otherwise noted)

Figure 1 - TVS Transients Clamping Waveform

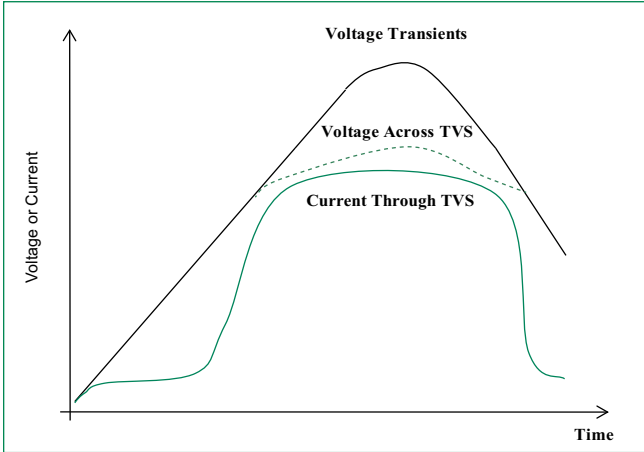

Figure 2 - Peak Pulse Power Rating

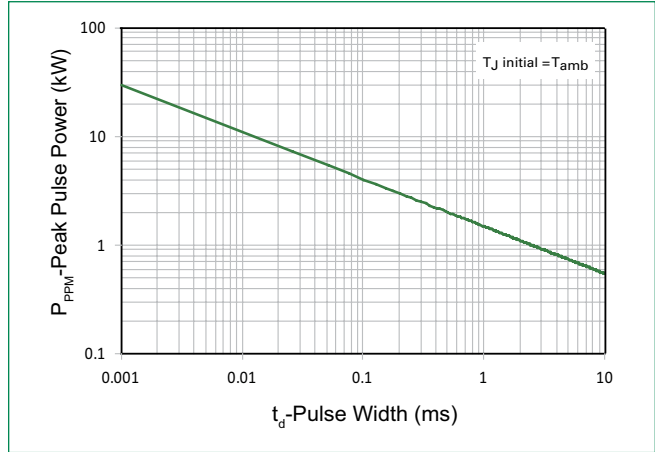

Figure 3 - Peak Pulse Power Derating Curve

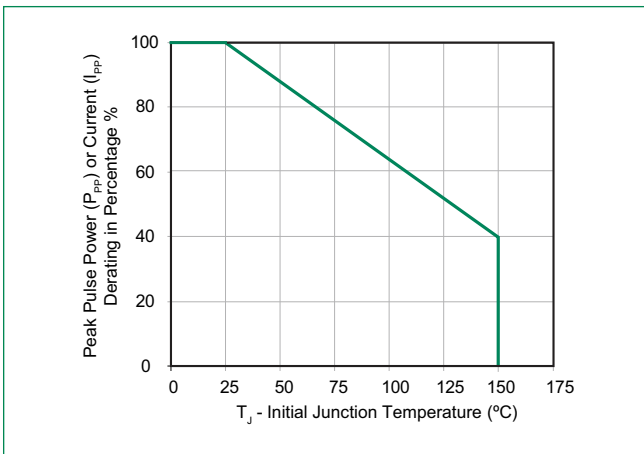

Figure 4 - Pulse Waveform

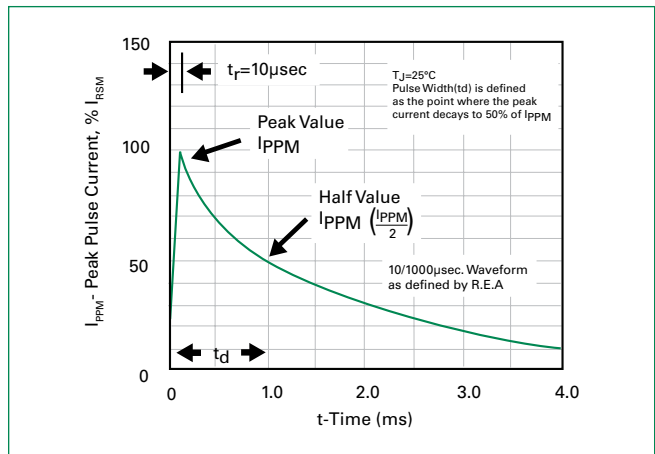

Figure 5 - Typical Junction Capacitance

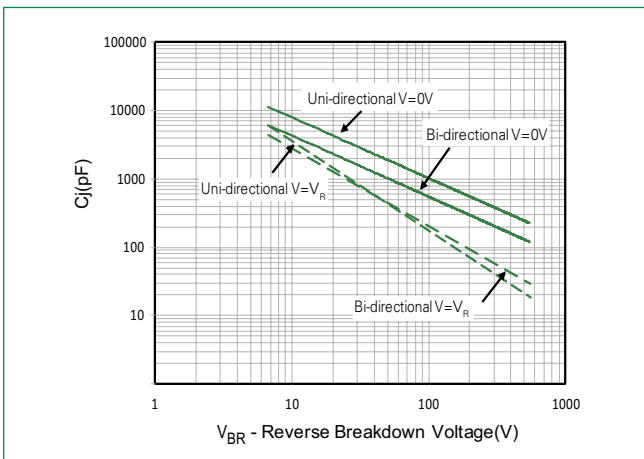

Figure 6 - Typical Transient Thermal Impedance

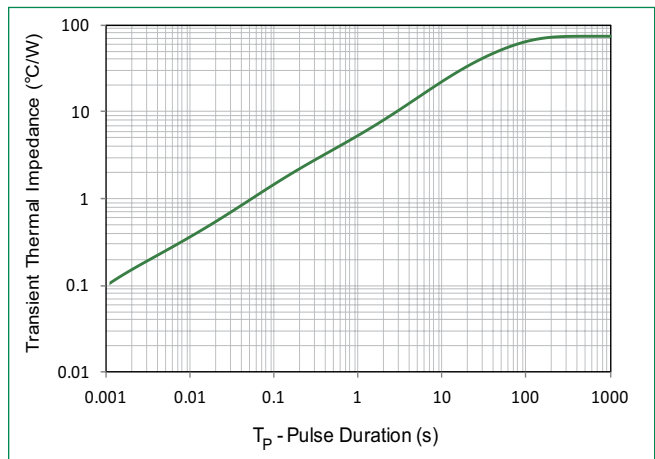

Figure 7 - Maximum Non-Repetitive Peak Forward Surge Current Uni-Directional Only



Soldering Parameters

Reflow Condition	Lead-free assembly	
Pre Heat	- Temperature Min ($T_{s(min)}$)	150°C
	- Temperature Max ($T_{s(max)}$)	200°C
	- Time (min to max) (t_s)	60 – 120 secs
Average ramp up rate (Liquidus Temp (T_L) to peak)	3°C/second max	
$T_{s(max)}$ to T_L - Ramp-up Rate	3°C/second max	
Reflow	- Temperature (T_L) (Liquidus)	217°C
	- Time (min to max) (t_s)	60 – 150 seconds
Peak Temperature (T_p)	260 ^{+0/-5} °C	
Time within 5°C of actual peak Temperature (t_p)	30 seconds	
Ramp-down Rate	6°C/second max	
Time 25°C to peak Temperature (T_p)	8 minutes Max.	
Do not exceed	260°C	



Physical Specifications

Weight	0.007 ounce, 0.21 grams
Case	JEDEC DO-215AB. Molded plastic body over glass passivated junction
Polarity	Color band denotes positive end (cathode) except Bidirectional.
Terminal	Matte Tin-plated leads, Solderable per JESD22-B102

Environmental Specifications

High Temp. Storage	JESD22-A103
HTRB	JESD22-A108
Thermal Shock	JESD22-A106
MSL	JEDEC-J-STD-020, Level 1
H3TRB	JESD22-A101
RSH	JESD22-A111

Dimensions



Dimensions	Inches		Millimeters	
	Min	Max	Min	Max
A	0.115	0.125	2.920	3.170
B	0.260	0.280	6.600	7.110
C	0.220	0.245	5.590	6.220
D	0.075	0.095	1.900	2.410
E	0.038	0.058	0.970	1.470
F	-	0.020	-	0.510
G	0.380	0.400	9.640	10.160
H	0.024	0.040	0.610	1.020
I	0.006	0.016	0.150	0.410
J	-	0.050	-	1.270
K	-	0.310	-	7.870
L	-	0.050	-	1.270
M	-	0.125	-	3.170
N	0.002	0.008	0.050	0.200

Part Numbering System



Part Marking System



Packaging

Part number	Component Package	Quantity	Packaging Option	Packaging Specification
SMCGxxxXX-HR	DO-215AB	1500	Tape & Reel – 24mm tape /13" reel	EIA STD RS-481

Tape and Reel Specification

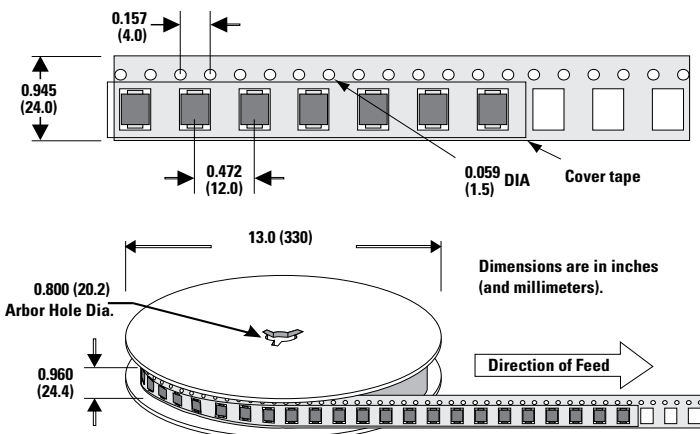

Disclaimer Notice - Information furnished is believed to be accurate and reliable. However, users should independently evaluate the suitability of and test each product selected for their own applications. Littelfuse products are not designed for, and may not be used in, all applications. Read complete Disclaimer Notice at <http://www.littelfuse.com/disclaimer-electronics>.

Looking for pricing, stock, or lifecycle information?

Click below to explore more details on WIN SOURCE:

 [View SMCG15CA-HR on WIN SOURCE](#)

 [Littelfuse Inc. Information](#)

Optimize Your Supply Chain with WIN SOURCE Solutions

-  Global Sourcing Solution
-  Obsolete Management
-  Cost Control Management
-  Shortage Management
-  Alternative Solution
-  Excess Inventory Management