



# THE DATASHEET OF SMDJ20A-HRA



# SMDJ-HRA Series

## Surface Mount – 3000W



### Additional Information



Resources



Accessories



Samples

### Agency Approvals

Agency	Agency File Number
	E230531

### Maximum Ratings and Thermal Characteristics

( $T_A = 25^\circ\text{C}$  unless otherwise noted)

Parameter	Symbol	Value	Unit
Peak Pulse Power Dissipation at $T_A = 25^\circ\text{C}$ by 10/1000 $\mu\text{s}$ waveform (Fig.1) <sup>(Note 1), (Note 2)</sup>	$P_{PPM}$	3000	W
Power Dissipation on infinite heat sink at $T_A = 50^\circ\text{C}$	$P_{M(AV)}$	6.5	W
Peak Forward Surge Current, 8.3ms Single Half Sine Wave <sup>(Note 3)</sup>	$I_{FSM}$	300	A
Maximum Instantaneous Forward Voltage at 100A for Unidirectional only	$V_F$	3.5	V
Operating Junction and Storage Temperature Range	$T_J, T_{STG}$	-65 to 150	$^\circ\text{C}$
Typical Thermal Resistance Junction to Lead	$R_{\theta JL}$	15	$^\circ\text{C/W}$
Typical Thermal Resistance Junction to Ambient	$R_{\theta JA}$	75	$^\circ\text{C/W}$

#### Notes:

- Non-repetitive current pulse, per Fig. 3 and derated above  $T_A = 25^\circ\text{C}$  per Fig. 2.
- Mounted on copper pad area of 0.31x0.31" (8.0 x 8.0mm) to each terminal.
- Measured on 8.3ms single half sine wave or equivalent square wave for unidirectional device only, duty cycle=4 per minute maximum.

### Description

The SMDJ-HRA High Reliability series is designed specifically to protect sensitive electronic equipment from voltage transients induced by lightning and other transient voltage events. These are available with a variety of up-screening options for enhanced reliability.

### Features & Benefits

- High reliability devices with fabrication and assembly lots traceability
- Enhanced reliability screening options are available in reference to MIL-PRF-19500. Refer to screen process table for more detail on screening options
- For surface mounted applications in order to optimize board space
- Low profile package
- Built-in strain relief
- $VBR @ T_J = VBR @ 25^\circ\text{C} \times (1 + \alpha T \times (T_J - 25))$  ( $\alpha T$ : Temperature Coefficient)
- Glass passivated chip junction
- 3000W peak pulse power capability at 10/1000 $\mu\text{s}$  waveform, repetition rate (duty cycles):0.01%
- Fast response time: typically less than 1.0ps from 0V to BV min
- Excellent clamping capability
- Low incremental surge resistance
- Typical IR less than 2 $\mu\text{A}$  above 12V
- High Temperature soldering guaranteed: 260 $^\circ\text{C}$ /40 seconds at terminals
- Plastic package has Underwriters laboratory flammability 94V-0
- Meet MSL level1, per J-STD-020, LF maximum peak of 260 $^\circ\text{C}$
- Matte tin lead-free plated
- Halogen free and RoHS compliant
- 2nd level interconnect is Pb-free per IPC/JEDEC J-STD-609A.01
- Recognized to UL 497B as an Isolated Loop Circuit Protector

### Applications

SMDJ-HRA devices are ideal for the high reliability protection of I/O Interfaces, VCC bus and other vulnerable circuits used in Telecom, Computer, Industrial and Consumer electronic applications.

### Functional Diagram



# SMDJ-HRA Series

## Surface Mount – 3000W

### Electrical Characteristics

Part Number (Uni)	Part Number (Bi)	Marking		Reverse Stand off Voltage $V_R$ (Volts)	Breakdown Voltage $V_{BR}$ (Volts) @ $I_T$		Test Current $I_T$ (mA)	Maximum Clamping Voltage $V_C$ @ $I_{PP}$ (V)	Maximum Peak Pulse Current $I_{PP}$ (A)	Maximum Reverse Leakage $I_R$ @ $V_R$ ( $\mu$ A)	Agency Approval 
		UNI	BI		MIN	MAX					
SMDJ5.0A-HRA	SMDJ5.0CA-HRA	RDEH	DDEH	5.0	6.40	7.00	10	9.2	326.1	800	X
SMDJ6.0A-HRA	SMDJ6.0CA-HRA	RDGH	DDGH	6.0	6.67	7.37	10	10.3	291.3	800	X
SMDJ6.5A-HRA	SMDJ6.5CA-HRA	RDKH	DDKH	6.5	7.22	7.98	10	11.2	267.9	500	X
SMDJ7.0A-HRA	SMDJ7.0CA-HRA	PDMH	DDMH	7.0	7.78	8.60	10	12.0	250.0	200	X
SMDJ7.5A-HRA	SMDJ7.5CA-HRA	PDPH	DDPH	7.5	8.33	9.21	1	12.9	232.6	100	X
SMDJ8.0A-HRA	SMDJ8.0CA-HRA	PDRH	DDRH	8.0	8.89	9.83	1	13.6	220.6	50	X
SMDJ8.5A-HRA	SMDJ8.5CA-HRA	PDTH	DDTH	8.5	9.44	10.40	1	14.4	208.3	20	X
SMDJ9.0A-HRA	SMDJ9.0CA-HRA	PDVH	DDVH	9.0	10.00	11.10	1	15.4	194.8	10	X
SMDJ10A-HRA	SMDJ10CA-HRA	PDXH	DDXH	10.0	11.10	12.30	1	17.0	176.5	5	X
SMDJ11A-HRA	SMDJ11CA-HRA	PDZH	DDZH	11.0	12.20	13.50	1	18.2	164.8	2	X
SMDJ12A-HRA	SMDJ12CA-HRA	PEEH	DEEH	12.0	13.30	14.70	1	19.9	150.8	2	X
SMDJ13A-HRA	SMDJ13CA-HRA	PEGH	DEGH	13.0	14.40	15.90	1	21.5	139.5	2	X
SMDJ14A-HRA	SMDJ14CA-HRA	PEKH	DEKH	14.0	15.60	17.20	1	23.2	129.3	2	X
SMDJ15A-HRA	SMDJ15CA-HRA	PEMH	DEMH	15.0	16.70	18.50	1	24.4	123.0	2	X
SMDJ16A-HRA	SMDJ16CA-HRA	PEPH	DEPH	16.0	17.80	19.70	1	26.0	115.4	2	X
SMDJ17A-HRA	SMDJ17CA-HRA	PERH	DERH	17.0	18.90	20.90	1	27.6	108.7	2	X
SMDJ18A-HRA	SMDJ18CA-HRA	PETH	DETH	18.0	20.00	22.10	1	29.2	102.7	2	X
SMDJ20A-HRA	SMDJ20CA-HRA	PEVH	DEVH	20.0	22.20	24.50	1	32.4	92.6	2	X
SMDJ22A-HRA	SMDJ22CA-HRA	PEXH	DEXH	22.0	24.40	26.90	1	35.5	84.5	2	X
SMDJ24A-HRA	SMDJ24CA-HRA	PEZH	DEZH	24.0	26.70	29.50	1	38.9	77.1	2	X
SMDJ26A-HRA	SMDJ26CA-HRA	PFEH	DFEH	26.0	28.90	31.90	1	42.1	71.3	2	X
SMDJ28A-HRA	SMDJ28CA-HRA	PFGH	DFGH	28.0	31.10	34.40	1	45.4	66.1	2	X
SMDJ30A-HRA	SMDJ30CA-HRA	PFKH	DFKH	30.0	33.30	36.80	1	48.4	62.0	2	X
SMDJ33A-HRA	SMDJ33CA-HRA	PFMH	DFMH	33.0	36.70	40.60	1	53.3	56.3	2	X
SMDJ36A-HRA	SMDJ36CA-HRA	PFPH	DFPH	36.0	40.00	44.20	1	58.1	51.6	2	X
SMDJ40A-HRA	SMDJ40CA-HRA	PFRH	DFRH	40.0	44.40	49.10	1	64.5	46.5	2	X
SMDJ43A-HRA	SMDJ43CA-HRA	PFTH	DFTH	43.0	47.80	52.80	1	69.4	43.2	2	X
SMDJ45A-HRA	SMDJ45CA-HRA	PFVH	DFVH	45.0	50.00	55.30	1	72.7	41.3	2	X
SMDJ48A-HRA	SMDJ48CA-HRA	PFXH	DFXH	48.0	53.30	58.90	1	77.4	38.8	2	X
SMDJ51A-HRA	SMDJ51CA-HRA	PFZH	DFZH	51.0	56.70	62.70	1	82.4	36.4	2	X
SMDJ54A-HRA	SMDJ54CA-HRA	RGEH	DGEH	54.0	60.00	66.30	1	87.1	34.4	2	X
SMDJ58A-HRA	SMDJ58CA-HRA	PGGH	DGGH	58.0	64.40	71.20	1	93.6	32.1	2	X
SMDJ60A-HRA	SMDJ60CA-HRA	PGKH	DGKH	60.0	66.70	73.70	1	96.8	31.0	2	X
SMDJ64A-HRA	SMDJ64CA-HRA	PGMH	DGMH	64.0	71.10	78.60	1	103.0	29.1	2	X
SMDJ70A-HRA	SMDJ70CA-HRA	PGPH	DGPH	70.0	77.80	86.00	1	113.0	26.5	2	X
SMDJ75A-HRA	SMDJ75CA-HRA	PGRH	DGRH	75.0	83.30	92.10	1	121.0	24.8	2	X
SMDJ78A-HRA	SMDJ78CA-HRA	PGTH	DGTH	78.0	86.70	95.80	1	126.0	23.8	2	X
SMDJ85A-HRA	SMDJ85CA-HRA	PGVH	DGVH	85.0	94.40	104.00	1	137.0	21.9	2	X
SMDJ90A-HRA	SMDJ90CA-HRA	PGXH	DGXH	90.0	100.00	111.00	1	146.0	20.5	2	X
SMDJ100A-HRA	SMDJ100CA-HRA	PGZH	DGZH	100.0	111.00	123.00	1	162.0	18.5	2	X
SMDJ110A-HRA	SMDJ110CA-HRA	PHEH	DHEH	110.0	122.00	135.00	1	177.0	16.9	2	X
SMDJ120A-HRA	SMDJ120CA-HRA	PHGH	DHGH	120.0	133.00	147.00	1	193.0	15.5	2	X
SMDJ130A-HRA	SMDJ130CA-HRA	PHKH	DHKH	130.0	144.00	159.00	1	209.0	14.4	2	X
SMDJ150A-HRA	SMDJ150CA-HRA	PHMH	DHMH	150.0	167.00	185.00	1	243.0	12.3	2	X
SMDJ170A-HRA	SMDJ170CA-HRA	PHRH	DHRH	170.0	189.00	209.00	1	275.0	10.9	2	X

**Note:**

1. SMDJ-HRA voltage binning can be specified by customer's request via contacting Littelfuse service

# SMDJ-HRA Series

## Surface Mount – 3000W

### Screen Process

100% Vision Inspection	MIL-STD-750 method 2074
100% High Temperature Storage Life (168hrs,175°C)	MIL-STD-750 method 1031
100% X-RAY inspection	MIL-STD-750 method 2076
100% Temperature Cycle Test (-55 to 150°C, 20 cycles, dwell time 15 min)	MIL-STD-750 method 1051
100% Reflow (2X)	JEDEC J-STD-020
100% Surge Test (2x)	MIL-STD-750 method 4066
100% HTRB 150°C Bias=VR(80% breakdown voltage, 96hrs, and each direction at 96 hrs for Bi-directional products)	MIL-STD-750 method 1038
Final Electrical Test( 100% 3 sigma limit, 100% dynamic test and PAT limit)	MIL-STD-750 method 4016.4021.4011

Note: Up-screen program can be specified by customer's request via contacting Littelfuse service

### I-V Curve Characteristics

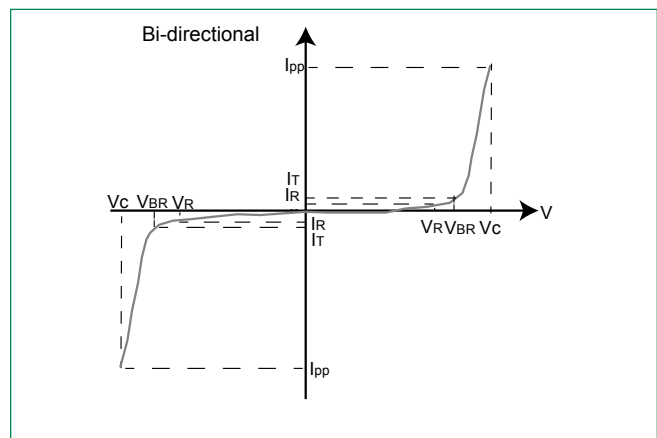
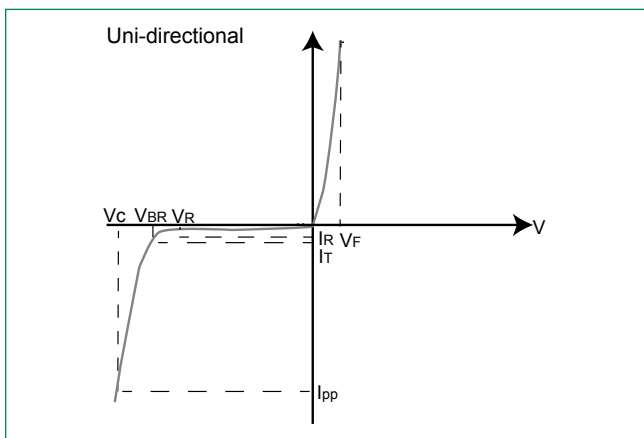

- P<sub>PPM</sub>** Peak Pulse Power Dissipation – Max power dissipation
- V<sub>R</sub>** Stand-off Voltage – Maximum voltage that can be applied to the TVS without operation
- V<sub>BR</sub>** Breakdown Voltage – Maximum voltage that flows though the TVS at a specified test current (I<sub>T</sub>)
- V<sub>C</sub>** Clamping Voltage – Peak voltage measured across the suppressor at a specified Ippm (peak impulse current)
- I<sub>R</sub>** Reverse Leakage Current – Current measured at V<sub>R</sub>
- V<sub>F</sub>** Forward Voltage Drop for Uni-directional

### Ratings and Characteristic Curves (T<sub>A</sub>=25°C unless otherwise noted)

**Figure 1 -**  
TVS Transients Clamping Waveform

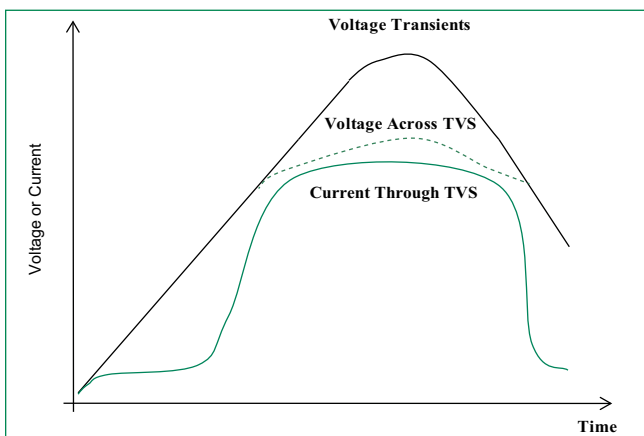

**Figure 2 -**  
Peak Pulse Power Rating

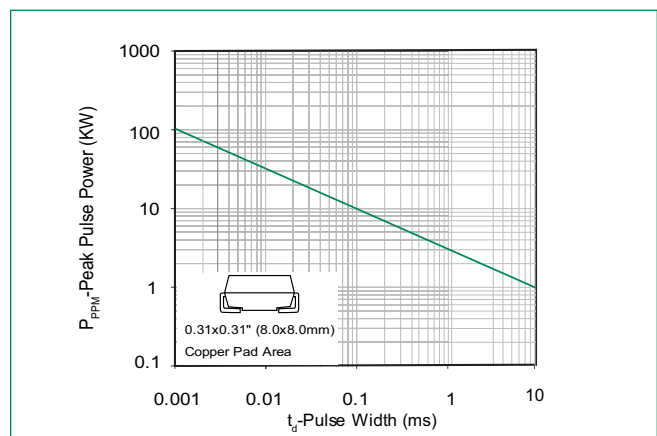

# SMDJ-HRA Series

## Surface Mount – 3000W

### Ratings and Characteristic Curves ( $T_A=25^\circ\text{C}$ unless otherwise noted) (Continued)

**Figure 3 -**  
Pulse Derating Curve

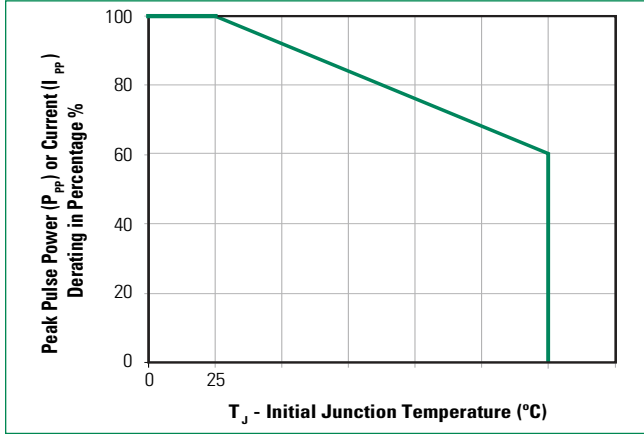

**Figure 4 -**  
Pulse Waveform

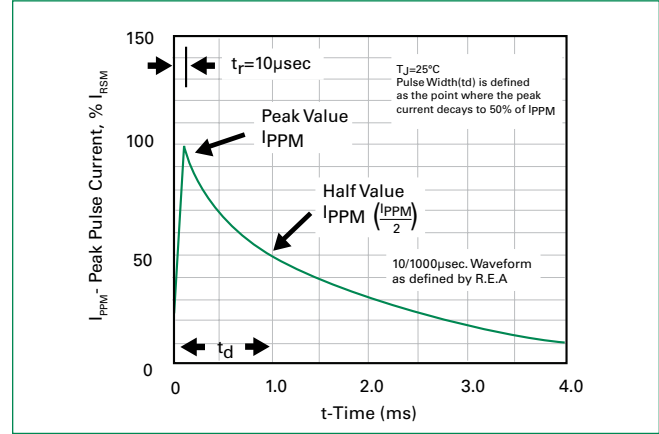

**Figure 5 -**  
Typical Junction Capacitance

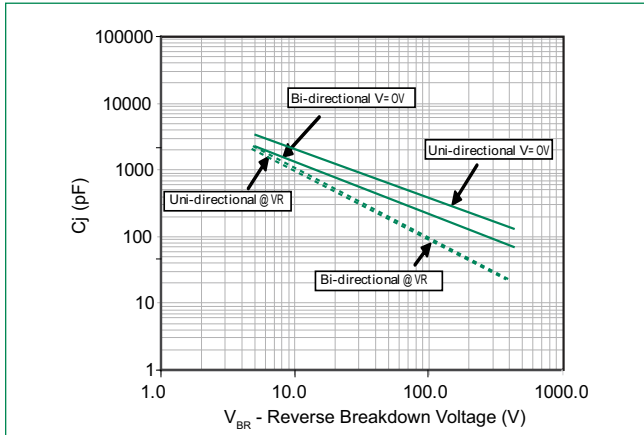

**Figure 6 -**  
Steady State Power Derating Curve

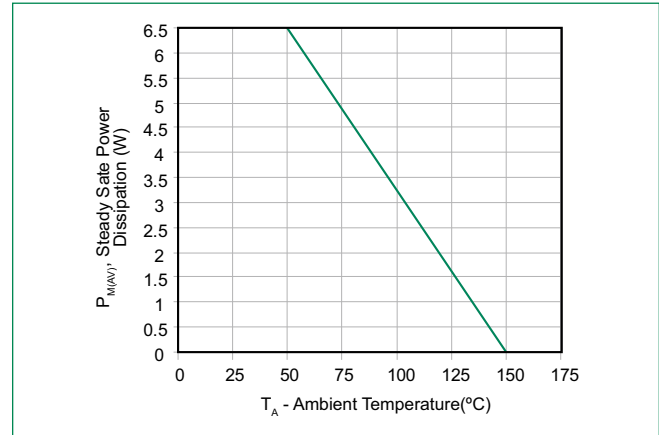

**Figure 7 -**  
Maximum Non-Repetitive Peak Forward Surge Current  
Uni-Directional only

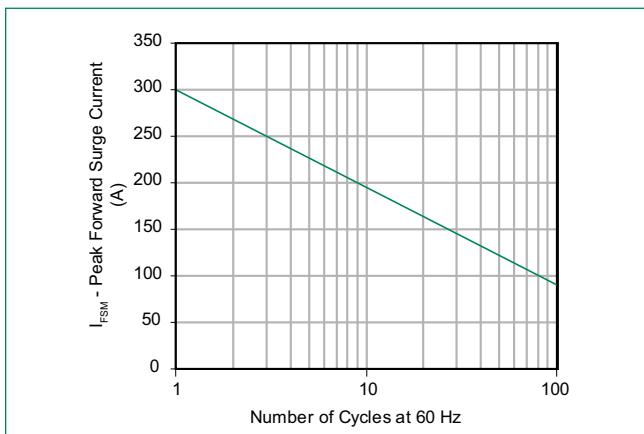

# SMDJ-HRA Series

## Surface Mount – 3000W

### Soldering Parameters

<b>Reflow Condition</b>		Lead-free assembly
<b>Pre Heat</b>	- Temperature Min ( $T_{s(min)}$ )	150°C
	- Temperature Max ( $T_{s(max)}$ )	200°C
	- Time (min to max) ( $t_s$ )	60 – 180 secs
<b>Average ramp up rate (Liquidus Temp (<math>T_L</math>) to peak)</b>		3°C/second max
<b><math>T_{s(max)}</math> to <math>T_L</math> - Ramp-up Rate</b>		3°C/second max
<b>Reflow</b>	- Temperature ( $T_L$ ) (Liquidus)	217°C
	- Time (min to max) ( $t_s$ )	60 – 150 seconds
<b>Peak Temperature (<math>T_p</math>)</b>		260 <sup>+0/-5</sup> °C
<b>Time within 5°C of actual peak Temperature (<math>t_p</math>)</b>		20 – 40 seconds
<b>Ramp-down Rate</b>		6°C/second max
<b>Time 25°C to peak Temperature (<math>T_p</math>)</b>		8 minutes Max.
<b>Do not exceed</b>		260°C



### Physical Specifications

<b>Weight</b>	0.007 ounce, 0.21 grams
<b>Case</b>	JEDEC DO214AB. Molded plastic body over glass passivated junction
<b>Polarity</b>	Color band denotes positive end (cathode) except Bidirectional.
<b>Terminal</b>	Matte Tin-plated leads, Solderable per JESD22-B102

### Environmental Specifications

<b>High Temp. Storage</b>	JESD22-A103
<b>HTRB</b>	JESD22-A108
<b>Thermal Shock</b>	JESD22-A106
<b>MSL</b>	JEDEC-J-STD-020, Level 1
<b>H3TRB</b>	JESD22-A101
<b>RSH</b>	JESD22-A111

### Dimensions



Dimensions	Inches		Millimeters	
	Min	Max	Min	Max
<b>A</b>	0.114	0.126	2.900	3.200
<b>B</b>	0.260	0.280	6.600	7.110
<b>C</b>	0.220	0.245	5.590	6.220
<b>D</b>	0.079	0.103	2.060	2.620
<b>E</b>	0.030	0.060	0.760	1.520
<b>F</b>	0.002	0.008	0.051	0.203
<b>G</b>	0.305	0.320	7.750	8.130
<b>H</b>	0.006	0.012	0.152	0.305
<b>I</b>	0.129	-	3.300	-
<b>J</b>	0.094	-	2.400	-
<b>K</b>	-	0.165	-	4.200
<b>L</b>	0.094	-	2.400	-

# SMDJ-HRA Series

Surface Mount – 3000W

### Part Numbering System

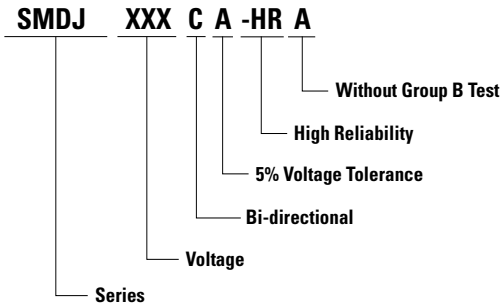

### Part Marking System



### Packaging

Part number	Component Package	Quantity	Packaging Option	Packaging Specification
SMDJxxxXX-HRA	DO-214AB	3000	Tape & Reel – 16mm tape /13" reel	EIA STD RS-481
SMDJxxxXX-HRAT7	DO-214AB	500	Tape & Reel – 16mm tape/7" reel	EIA STD RS-481

### Tape and Reel Specification



# SMDJ-HRA Series

Surface Mount – 3000W

**RTCA/DO-160G Wave 3**



**RTCA/DO-160G Wave 4**



**RTCA/DO-160G Wave 5**



# SMDJ-HRA Series

## Surface Mount – 3000W

### Pin Injection Protection Per RTCA/DO-160G

Part Number (Uni)	Part Number (Bi)	25C						70C						120C					
		Wave 3		Wave 4 (6.4/69us)		Wave 5a (40/120us)		Wave 3		Wave 4 (6.4/69us)		Wave 5a (40/120us)		Wave 3		Wave 4 (6.4/69us)		Wave 5a (40/120us)	
		L5	L3	L4	L5	L3	L4	L5	L3	L4	L5	L3	L4	L5	L3	L4	L5	L3	L4
		128A	60A	150A	320A	300A	750A	128A	60A	150A	320A	300A	750A	128A	60A	150A	320A	300A	750A
SMDJ5.0A-HRA	SMDJ5.0CA-HRA	pass	pass	pass	pass	pass	pass	pass	pass	pass	pass	pass	pass	pass	pass	pass	pass	pass	pass
SMDJ6.0A-HRA	SMDJ6.0CA-HRA	pass	pass	pass	pass	pass	pass	pass	pass	pass	pass	pass	pass	pass	pass	pass	pass	pass	pass
SMDJ6.5A-HRA	SMDJ6.5CA-HRA	pass	pass	pass	pass	pass	pass	pass	pass	pass	pass	pass	pass	pass	pass	pass	pass	pass	pass
SMDJ7.0A-HRA	SMDJ7.0CA-HRA	pass	pass	pass	pass	pass	pass	pass	pass	pass	pass	pass	pass	pass	pass	pass	pass	pass	pass
SMDJ7.5A-HRA	SMDJ7.5CA-HRA	pass	pass	pass	pass	pass	pass	pass	pass	pass	pass	pass	pass	pass	pass	pass	pass	pass	pass
SMDJ8.0A-HRA	SMDJ8.0CA-HRA	pass	pass	pass	pass	pass	pass	pass	pass	pass	pass	pass	pass	pass	pass	pass	pass	pass	pass
SMDJ8.5A-HRA	SMDJ8.5CA-HRA	pass	pass	pass	pass	pass	pass	pass	pass	pass	pass	pass	pass	pass	pass	pass	pass	pass	pass
SMDJ9.0A-HRA	SMDJ9.0CA-HRA	pass	pass	pass	pass	pass	pass	pass	pass	pass	pass	pass	pass	pass	pass	pass	pass	pass	pass
SMDJ10A-HRA	SMDJ10CA-HRA	pass	pass	pass	pass	pass	pass	pass	pass	pass	pass	pass	pass	pass	pass	pass	pass	pass	pass
SMDJ11A-HRA	SMDJ11CA-HRA	pass	pass	pass	pass	pass	-	pass	pass	pass	pass	pass	pass	pass	pass	pass	pass	pass	pass
SMDJ12A-HRA	SMDJ12CA-HRA	pass	pass	pass	pass	pass	-	pass	pass	pass	pass	pass	pass	pass	pass	pass	pass	pass	pass
SMDJ13A-HRA	SMDJ13CA-HRA	pass	pass	pass	pass	pass	-	pass	pass	pass	pass	pass	pass	pass	pass	pass	pass	pass	pass
SMDJ14A-HRA	SMDJ14CA-HRA	pass	pass	pass	pass	pass	-	pass	pass	pass	pass	pass	pass	pass	pass	pass	pass	pass	pass
SMDJ15A-HRA	SMDJ15CA-HRA	pass	pass	pass	pass	pass	-	pass	pass	pass	pass	pass	pass	pass	pass	pass	pass	pass	pass
SMDJ16A-HRA	SMDJ16CA-HRA	pass	pass	pass	pass	pass	-	pass	pass	pass	pass	pass	pass	pass	pass	pass	pass	pass	pass
SMDJ17A-HRA	SMDJ17CA-HRA	pass	pass	pass	pass	pass	-	pass	pass	pass	pass	pass	pass	pass	pass	pass	pass	pass	pass
SMDJ18A-HRA	SMDJ18CA-HRA	pass	pass	pass	pass	pass	-	pass	pass	pass	pass	pass	pass	pass	pass	pass	pass	pass	pass
SMDJ20A-HRA	SMDJ20CA-HRA	pass	pass	pass	pass	pass	-	pass	pass	pass	pass	pass	pass	pass	pass	pass	pass	pass	pass
SMDJ22A-HRA	SMDJ22CA-HRA	pass	pass	pass	-	-	-	pass	pass	pass	-	-	-	pass	pass	pass	-	-	-
SMDJ24A-HRA	SMDJ24CA-HRA	pass	pass	pass	-	-	-	pass	pass	pass	-	-	-	pass	pass	pass	-	-	-
SMDJ26A-HRA	SMDJ26CA-HRA	pass	pass	pass	-	-	-	pass	pass	pass	-	-	-	pass	pass	pass	-	-	-
SMDJ28A-HRA	SMDJ28CA-HRA	pass	pass	pass	-	-	-	pass	pass	pass	-	-	-	pass	pass	pass	-	-	-
SMDJ30A-HRA	SMDJ30CA-HRA	pass	pass	pass	-	-	-	pass	pass	pass	-	-	-	pass	pass	pass	-	-	-
SMDJ33A-HRA	SMDJ33CA-HRA	pass	pass	pass	-	-	-	pass	pass	pass	-	-	-	pass	pass	pass	-	-	-
SMDJ36A-HRA	SMDJ36CA-HRA	pass	pass	pass	-	-	-	pass	pass	pass	-	-	-	pass	pass	pass	-	-	-
SMDJ40A-HRA	SMDJ40CA-HRA	pass	pass	pass	-	-	-	pass	pass	pass	-	-	-	pass	pass	pass	-	-	-
SMDJ43A-HRA	SMDJ43CA-HRA	pass	pass	pass	-	-	-	pass	pass	pass	-	-	-	pass	pass	pass	-	-	-
SMDJ45A-HRA	SMDJ45CA-HRA	pass	pass	pass	-	-	-	pass	pass	pass	-	-	-	pass	pass	pass	-	-	-
SMDJ48A-HRA	SMDJ48CA-HRA	pass	pass	pass	-	-	-	pass	pass	pass	-	-	-	pass	pass	pass	-	-	-
SMDJ51A-HRA	SMDJ51CA-HRA	pass	pass	pass	-	-	-	pass	pass	pass	-	-	-	pass	pass	pass	-	-	-
SMDJ54A-HRA	SMDJ54CA-HRA	pass	pass	pass	-	-	-	pass	pass	pass	-	-	-	pass	pass	pass	-	-	-
SMDJ58A-HRA	-	pass	pass	-	-	-	-	pass	pass	pass	-	-	-	pass	pass	pass	-	-	-
SMDJ60A-HRA	SMDJ60CA-HRA	pass	pass	-	-	-	-	pass	pass	pass	-	-	-	pass	pass	pass	-	-	-
SMDJ64A-HRA	-	pass	pass	-	-	-	-	pass	pass	pass	-	-	-	pass	pass	pass	-	-	-
SMDJ70A-HRA	-	pass	pass	-	-	-	-	pass	pass	pass	-	-	-	pass	pass	pass	-	-	-
SMDJ75A-HRA	-	pass	pass	-	-	-	-	pass	pass	pass	-	-	-	pass	pass	pass	-	-	-
SMDJ78A-HRA	-	pass	pass	-	-	-	-	pass	pass	pass	-	-	-	pass	pass	pass	-	-	-
SMDJ85A-HRA	-	pass	pass	-	-	-	-	pass	pass	pass	-	-	-	pass	pass	pass	-	-	-
SMDJ90A-HRA	-	pass	pass	-	-	-	-	pass	pass	pass	-	-	-	pass	pass	pass	-	-	-
SMDJ100A-HRA	-	pass	pass	-	-	-	-	pass	pass	pass	-	-	-	pass	pass	pass	-	-	-
SMDJ110A-HRA	-	pass	pass	-	-	-	-	pass	pass	pass	-	-	-	pass	pass	pass	-	-	-
SMDJ120A-HRA	-	pass	pass	-	-	-	-	pass	pass	pass	-	-	-	pass	pass	pass	-	-	-
SMDJ130A-HRA	-	pass	pass	-	-	-	-	pass	pass	pass	-	-	-	pass	pass	pass	-	-	-
SMDJ150A-HRA	-	pass	pass	-	-	-	-	pass	pass	pass	-	-	-	pass	pass	pass	-	-	-
SMDJ170A-HRA	-	pass	pass	-	-	-	-	pass	pass	pass	-	-	-	pass	pass	pass	-	-	-

**Note:**

1. L1 = Level 1, L2 = Level 2, L3 = Level 3, L4 = Level 4, L5 = Level 5

**Disclaimer Notice** - Information furnished is believed to be accurate and reliable. However, users should independently evaluate the suitability of and test each product selected for their own applications. Littelfuse products are not designed for, and may not be used in, all applications. Read complete Disclaimer Notice at <http://www.littelfuse.com/disclaimer-electronics>.

## Looking for pricing, stock, or lifecycle information?

Click below to explore more details on WIN SOURCE:

 [View SMDJ20A-HRA on WIN SOURCE](#)

 [Littelfuse Inc. Information](#)

## Optimize Your Supply Chain with WIN SOURCE Solutions

-  Global Sourcing Solution
-  Obsolete Management
-  Cost Control Management
-  Shortage Management
-  Alternative Solution
-  Excess Inventory Management