



THE DATASHEET OF SMDJ90A-HRA



SMDJ-HRA Series

Surface Mount – 3000W



Additional Information



Resources



Accessories



Samples

Agency Approvals

| Agency | Agency File Number |
|--------|--------------------|
| | E230531 |

Maximum Ratings and Thermal Characteristics

($T_A = 25^\circ\text{C}$ unless otherwise noted)

| Parameter | Symbol | Value | Unit |
|--|-----------------|------------|--------------------|
| Peak Pulse Power Dissipation at $T_A = 25^\circ\text{C}$ by 10/1000 μs waveform (Fig.1) ^{(Note 1), (Note 2)} | P_{PPM} | 3000 | W |
| Power Dissipation on infinite heat sink at $T_A = 50^\circ\text{C}$ | $P_{M(AV)}$ | 6.5 | W |
| Peak Forward Surge Current, 8.3ms Single Half Sine Wave ^(Note 3) | I_{FSM} | 300 | A |
| Maximum Instantaneous Forward Voltage at 100A for Unidirectional only | V_F | 3.5 | V |
| Operating Junction and Storage Temperature Range | T_J, T_{STG} | -65 to 150 | $^\circ\text{C}$ |
| Typical Thermal Resistance Junction to Lead | $R_{\theta JL}$ | 15 | $^\circ\text{C/W}$ |
| Typical Thermal Resistance Junction to Ambient | $R_{\theta JA}$ | 75 | $^\circ\text{C/W}$ |

Notes:

- Non-repetitive current pulse, per Fig. 3 and derated above $T_A = 25^\circ\text{C}$ per Fig. 2.
- Mounted on copper pad area of 0.31x0.31" (8.0 x 8.0mm) to each terminal.
- Measured on 8.3ms single half sine wave or equivalent square wave for unidirectional device only, duty cycle=4 per minute maximum.

Description

The SMDJ-HRA High Reliability series is designed specifically to protect sensitive electronic equipment from voltage transients induced by lightning and other transient voltage events. These are available with a variety of up-screening options for enhanced reliability.

Features & Benefits

- High reliability devices with fabrication and assembly lots traceability
- Enhanced reliability screening options are available in reference to MIL-PRF-19500. Refer to screen process table for more detail on screening options
- For surface mounted applications in order to optimize board space
- Low profile package
- Built-in strain relief
- $VBR @ T_J = VBR @ 25^\circ\text{C} \times (1 + \alpha T \times (T_J - 25))$ (αT : Temperature Coefficient)
- Glass passivated chip junction
- 3000W peak pulse power capability at 10/1000 μs waveform, repetition rate (duty cycles):0.01%
- Fast response time: typically less than 1.0ps from 0V to BV min
- Excellent clamping capability
- Low incremental surge resistance
- Typical IR less than 2 μA above 12V
- High Temperature soldering guaranteed: 260 $^\circ\text{C}$ /40 seconds at terminals
- Plastic package has Underwriters laboratory flammability 94V-0
- Meet MSL level1, per J-STD-020, LF maximum peak of 260 $^\circ\text{C}$
- Matte tin lead-free plated
- Halogen free and RoHS compliant
- 2nd level interconnect is Pb-free per IPC/JEDEC J-STD-609A.01
- Recognized to UL 497B as an Isolated Loop Circuit Protector

Applications

SMDJ-HRA devices are ideal for the high reliability protection of I/O Interfaces, VCC bus and other vulnerable circuits used in Telecom, Computer, Industrial and Consumer electronic applications.

Functional Diagram

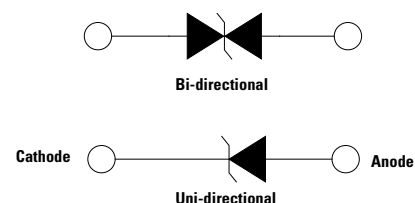

SMDJ-HRA Series

Surface Mount – 3000W

Electrical Characteristics

| Part Number (Uni) | Part Number (Bi) | Marking | | Reverse Stand off Voltage V_R (Volts) | Breakdown Voltage V_{BR} (Volts) @ I_T | | Test Current I_T (mA) | Maximum Clamping Voltage V_C @ I_{PP} (V) | Maximum Peak Pulse Current I_{PP} (A) | Maximum Reverse Leakage I_R @ V_R (μ A) | Agency Approval  |
|-------------------|------------------|---------|------|---|--|--------|-------------------------|---|---|--|---|
| | | UNI | BI | | MIN | MAX | | | | | |
| SMDJ5.0A-HRA | SMDJ5.0CA-HRA | RDEH | DDEH | 5.0 | 6.40 | 7.00 | 10 | 9.2 | 326.1 | 800 | X |
| SMDJ6.0A-HRA | SMDJ6.0CA-HRA | RDGH | DDGH | 6.0 | 6.67 | 7.37 | 10 | 10.3 | 291.3 | 800 | X |
| SMDJ6.5A-HRA | SMDJ6.5CA-HRA | RDKH | DDKH | 6.5 | 7.22 | 7.98 | 10 | 11.2 | 267.9 | 500 | X |
| SMDJ7.0A-HRA | SMDJ7.0CA-HRA | PDMH | DDMH | 7.0 | 7.78 | 8.60 | 10 | 12.0 | 250.0 | 200 | X |
| SMDJ7.5A-HRA | SMDJ7.5CA-HRA | PDPH | DDPH | 7.5 | 8.33 | 9.21 | 1 | 12.9 | 232.6 | 100 | X |
| SMDJ8.0A-HRA | SMDJ8.0CA-HRA | PDRH | DDRH | 8.0 | 8.89 | 9.83 | 1 | 13.6 | 220.6 | 50 | X |
| SMDJ8.5A-HRA | SMDJ8.5CA-HRA | PDTH | DDTH | 8.5 | 9.44 | 10.40 | 1 | 14.4 | 208.3 | 20 | X |
| SMDJ9.0A-HRA | SMDJ9.0CA-HRA | PDVH | DDVH | 9.0 | 10.00 | 11.10 | 1 | 15.4 | 194.8 | 10 | X |
| SMDJ10A-HRA | SMDJ10CA-HRA | PDXH | DDXH | 10.0 | 11.10 | 12.30 | 1 | 17.0 | 176.5 | 5 | X |
| SMDJ11A-HRA | SMDJ11CA-HRA | PDZH | DDZH | 11.0 | 12.20 | 13.50 | 1 | 18.2 | 164.8 | 2 | X |
| SMDJ12A-HRA | SMDJ12CA-HRA | PEEH | DEEH | 12.0 | 13.30 | 14.70 | 1 | 19.9 | 150.8 | 2 | X |
| SMDJ13A-HRA | SMDJ13CA-HRA | PEGH | DEGH | 13.0 | 14.40 | 15.90 | 1 | 21.5 | 139.5 | 2 | X |
| SMDJ14A-HRA | SMDJ14CA-HRA | PEKH | DEKH | 14.0 | 15.60 | 17.20 | 1 | 23.2 | 129.3 | 2 | X |
| SMDJ15A-HRA | SMDJ15CA-HRA | PEMH | DEMH | 15.0 | 16.70 | 18.50 | 1 | 24.4 | 123.0 | 2 | X |
| SMDJ16A-HRA | SMDJ16CA-HRA | PEPH | DEPH | 16.0 | 17.80 | 19.70 | 1 | 26.0 | 115.4 | 2 | X |
| SMDJ17A-HRA | SMDJ17CA-HRA | PERH | DERH | 17.0 | 18.90 | 20.90 | 1 | 27.6 | 108.7 | 2 | X |
| SMDJ18A-HRA | SMDJ18CA-HRA | PETH | DETH | 18.0 | 20.00 | 22.10 | 1 | 29.2 | 102.7 | 2 | X |
| SMDJ20A-HRA | SMDJ20CA-HRA | PEVH | DEVH | 20.0 | 22.20 | 24.50 | 1 | 32.4 | 92.6 | 2 | X |
| SMDJ22A-HRA | SMDJ22CA-HRA | PEXH | DEXH | 22.0 | 24.40 | 26.90 | 1 | 35.5 | 84.5 | 2 | X |
| SMDJ24A-HRA | SMDJ24CA-HRA | PEZH | DEZH | 24.0 | 26.70 | 29.50 | 1 | 38.9 | 77.1 | 2 | X |
| SMDJ26A-HRA | SMDJ26CA-HRA | PFEH | DFEH | 26.0 | 28.90 | 31.90 | 1 | 42.1 | 71.3 | 2 | X |
| SMDJ28A-HRA | SMDJ28CA-HRA | PFGH | DFGH | 28.0 | 31.10 | 34.40 | 1 | 45.4 | 66.1 | 2 | X |
| SMDJ30A-HRA | SMDJ30CA-HRA | PFKH | DFKH | 30.0 | 33.30 | 36.80 | 1 | 48.4 | 62.0 | 2 | X |
| SMDJ33A-HRA | SMDJ33CA-HRA | PFMH | DFMH | 33.0 | 36.70 | 40.60 | 1 | 53.3 | 56.3 | 2 | X |
| SMDJ36A-HRA | SMDJ36CA-HRA | PFPH | DFPH | 36.0 | 40.00 | 44.20 | 1 | 58.1 | 51.6 | 2 | X |
| SMDJ40A-HRA | SMDJ40CA-HRA | PFRH | DFRH | 40.0 | 44.40 | 49.10 | 1 | 64.5 | 46.5 | 2 | X |
| SMDJ43A-HRA | SMDJ43CA-HRA | PFTH | DFTH | 43.0 | 47.80 | 52.80 | 1 | 69.4 | 43.2 | 2 | X |
| SMDJ45A-HRA | SMDJ45CA-HRA | PFVH | DFVH | 45.0 | 50.00 | 55.30 | 1 | 72.7 | 41.3 | 2 | X |
| SMDJ48A-HRA | SMDJ48CA-HRA | PFXH | DFXH | 48.0 | 53.30 | 58.90 | 1 | 77.4 | 38.8 | 2 | X |
| SMDJ51A-HRA | SMDJ51CA-HRA | PFZH | DFZH | 51.0 | 56.70 | 62.70 | 1 | 82.4 | 36.4 | 2 | X |
| SMDJ54A-HRA | SMDJ54CA-HRA | RGEH | DGEH | 54.0 | 60.00 | 66.30 | 1 | 87.1 | 34.4 | 2 | X |
| SMDJ58A-HRA | SMDJ58CA-HRA | PGGH | DGGH | 58.0 | 64.40 | 71.20 | 1 | 93.6 | 32.1 | 2 | X |
| SMDJ60A-HRA | SMDJ60CA-HRA | PGKH | DGKH | 60.0 | 66.70 | 73.70 | 1 | 96.8 | 31.0 | 2 | X |
| SMDJ64A-HRA | SMDJ64CA-HRA | PGMH | DGMH | 64.0 | 71.10 | 78.60 | 1 | 103.0 | 29.1 | 2 | X |
| SMDJ70A-HRA | SMDJ70CA-HRA | PGPH | DGPH | 70.0 | 77.80 | 86.00 | 1 | 113.0 | 26.5 | 2 | X |
| SMDJ75A-HRA | SMDJ75CA-HRA | PGRH | DGRH | 75.0 | 83.30 | 92.10 | 1 | 121.0 | 24.8 | 2 | X |
| SMDJ78A-HRA | SMDJ78CA-HRA | PGTH | DGTH | 78.0 | 86.70 | 95.80 | 1 | 126.0 | 23.8 | 2 | X |
| SMDJ85A-HRA | SMDJ85CA-HRA | PGVH | DGVH | 85.0 | 94.40 | 104.00 | 1 | 137.0 | 21.9 | 2 | X |
| SMDJ90A-HRA | SMDJ90CA-HRA | PGXH | DGXH | 90.0 | 100.00 | 111.00 | 1 | 146.0 | 20.5 | 2 | X |
| SMDJ100A-HRA | SMDJ100CA-HRA | PGZH | DGZH | 100.0 | 111.00 | 123.00 | 1 | 162.0 | 18.5 | 2 | X |
| SMDJ110A-HRA | SMDJ110CA-HRA | PHEH | DHEH | 110.0 | 122.00 | 135.00 | 1 | 177.0 | 16.9 | 2 | X |
| SMDJ120A-HRA | SMDJ120CA-HRA | PHGH | DHGH | 120.0 | 133.00 | 147.00 | 1 | 193.0 | 15.5 | 2 | X |
| SMDJ130A-HRA | SMDJ130CA-HRA | PHKH | DHKH | 130.0 | 144.00 | 159.00 | 1 | 209.0 | 14.4 | 2 | X |
| SMDJ150A-HRA | SMDJ150CA-HRA | PHMH | DHMH | 150.0 | 167.00 | 185.00 | 1 | 243.0 | 12.3 | 2 | X |
| SMDJ170A-HRA | SMDJ170CA-HRA | PHRH | DHRH | 170.0 | 189.00 | 209.00 | 1 | 275.0 | 10.9 | 2 | X |

Note:

1. SMDJ-HRA voltage binning can be specified by customer's request via contacting Littelfuse service

SMDJ-HRA Series

Surface Mount – 3000W

Screen Process

| | |
|---|-----------------------------------|
| 100% Vision Inspection | MIL-STD-750 method 2074 |
| 100% High Temperature Storage Life (168hrs,175°C) | MIL-STD-750 method 1031 |
| 100% X-RAY inspection | MIL-STD-750 method 2076 |
| 100% Temperature Cycle Test (-55 to 150°C, 20 cycles, dwell time 15 min) | MIL-STD-750 method 1051 |
| 100% Reflow (2X) | JEDEC J-STD-020 |
| 100% Surge Test (2x) | MIL-STD-750 method 4066 |
| 100% HTRB 150°C Bias=VR(80% breakdown voltage, 96hrs, and each direction at 96 hrs for Bi-directional products) | MIL-STD-750 method 1038 |
| Final Electrical Test(100% 3 sigma limit, 100% dynamic test and PAT limit) | MIL-STD-750 method 4016.4021.4011 |

Note: Up-screen program can be specified by customer's request via contacting Littelfuse service

I-V Curve Characteristics

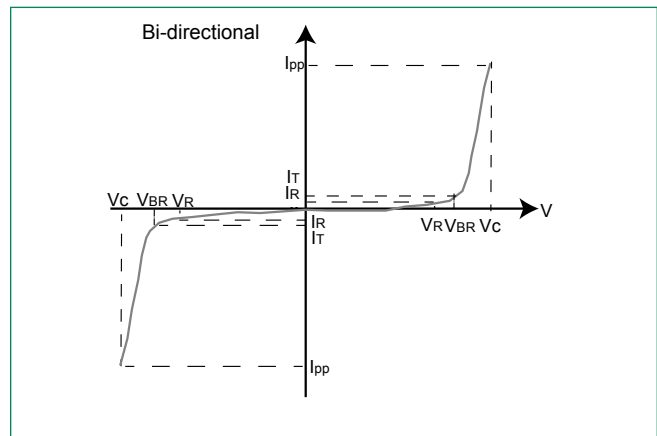
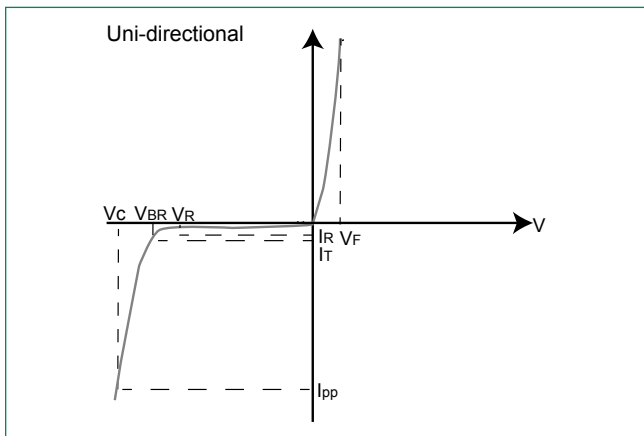

- P_{PPM}** Peak Pulse Power Dissipation – Max power dissipation
- V_R** Stand-off Voltage – Maximum voltage that can be applied to the TVS without operation
- V_{BR}** Breakdown Voltage – Maximum voltage that flows though the TVS at a specified test current (I_T)
- V_C** Clamping Voltage – Peak voltage measured across the suppressor at a specified Ippm (peak impulse current)
- I_R** Reverse Leakage Current – Current measured at V_R
- V_F** Forward Voltage Drop for Uni-directional

Ratings and Characteristic Curves (T_A=25°C unless otherwise noted)

Figure 1 -
TVS Transients Clamping Waveform

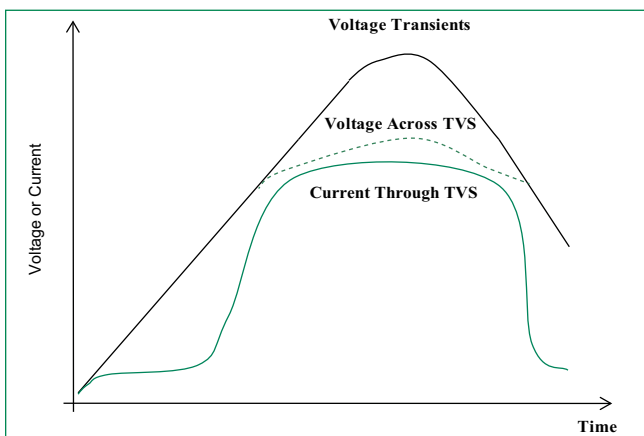
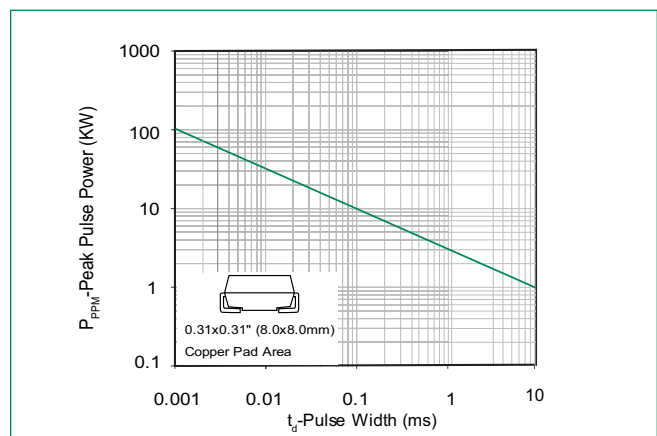

Figure 2 -
Peak Pulse Power Rating



SMDJ-HRA Series

Surface Mount – 3000W

Ratings and Characteristic Curves ($T_A=25^\circ\text{C}$ unless otherwise noted) (Continued)

Figure 3 -
Pulse Derating Curve



Figure 4 -
Pulse Waveform



Figure 5 -
Typical Junction Capacitance



Figure 6 -
Steady State Power Derating Curve



Figure 7 -
Maximum Non-Repetitive Peak Forward Surge Current
Uni-Directional only



SMDJ-HRA Series

Surface Mount – 3000W

Soldering Parameters

| | | |
|--|------------------------------------|-------------------------|
| Reflow Condition | | Lead-free assembly |
| Pre Heat | - Temperature Min ($T_{s(min)}$) | 150°C |
| | - Temperature Max ($T_{s(max)}$) | 200°C |
| | - Time (min to max) (t_s) | 60 – 180 secs |
| Average ramp up rate (Liquidus Temp (T_L) to peak) | | 3°C/second max |
| $T_{s(max)}$ to T_L - Ramp-up Rate | | 3°C/second max |
| Reflow | - Temperature (T_L) (Liquidus) | 217°C |
| | - Time (min to max) (t_s) | 60 – 150 seconds |
| Peak Temperature (T_p) | | 260 ^{+0/-5} °C |
| Time within 5°C of actual peak Temperature (t_p) | | 20 – 40 seconds |
| Ramp-down Rate | | 6°C/second max |
| Time 25°C to peak Temperature (T_p) | | 8 minutes Max. |
| Do not exceed | | 260°C |



Physical Specifications

| | |
|-----------------|---|
| Weight | 0.007 ounce, 0.21 grams |
| Case | JEDEC DO214AB. Molded plastic body over glass passivated junction |
| Polarity | Color band denotes positive end (cathode) except Bidirectional. |
| Terminal | Matte Tin-plated leads, Solderable per JESD22-B102 |

Environmental Specifications

| | |
|---------------------------|--------------------------|
| High Temp. Storage | JESD22-A103 |
| HTRB | JESD22-A108 |
| Thermal Shock | JESD22-A106 |
| MSL | JEDEC-J-STD-020, Level 1 |
| H3TRB | JESD22-A101 |
| RSH | JESD22-A111 |

Dimensions



| Dimensions | Inches | | Millimeters | |
|------------|--------|-------|-------------|-------|
| | Min | Max | Min | Max |
| A | 0.114 | 0.126 | 2.900 | 3.200 |
| B | 0.260 | 0.280 | 6.600 | 7.110 |
| C | 0.220 | 0.245 | 5.590 | 6.220 |
| D | 0.079 | 0.103 | 2.060 | 2.620 |
| E | 0.030 | 0.060 | 0.760 | 1.520 |
| F | 0.002 | 0.008 | 0.051 | 0.203 |
| G | 0.305 | 0.320 | 7.750 | 8.130 |
| H | 0.006 | 0.012 | 0.152 | 0.305 |
| I | 0.129 | - | 3.300 | - |
| J | 0.094 | - | 2.400 | - |
| K | - | 0.165 | - | 4.200 |
| L | 0.094 | - | 2.400 | - |

SMDJ-HRA Series

Surface Mount – 3000W

Part Numbering System

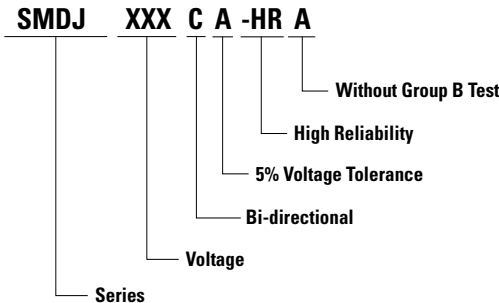

Part Marking System



Packaging

| Part number | Component Package | Quantity | Packaging Option | Packaging Specification |
|-----------------|-------------------|----------|-----------------------------------|-------------------------|
| SMDJxxxXX-HRA | DO-214AB | 3000 | Tape & Reel – 16mm tape /13" reel | EIA STD RS-481 |
| SMDJxxxXX-HRAT7 | DO-214AB | 500 | Tape & Reel – 16mm tape/7" reel | EIA STD RS-481 |

Tape and Reel Specification



SMDJ-HRA Series

Surface Mount – 3000W

RTCA/DO-160G Wave 3

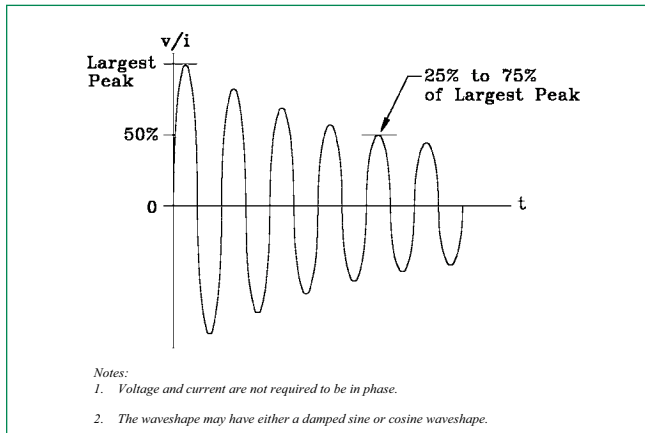

RTCA/DO-160G Wave 4

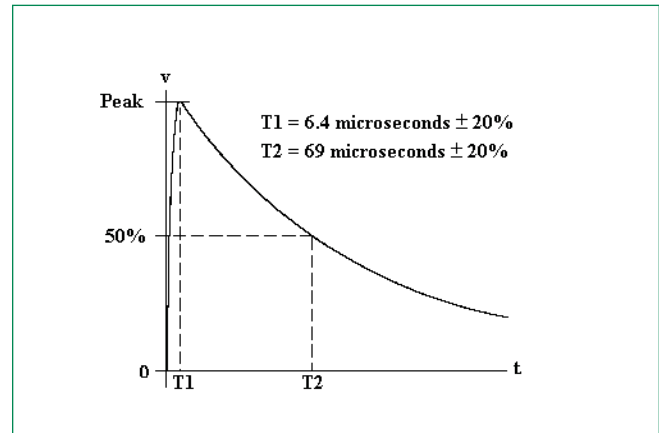

RTCA/DO-160G Wave 5

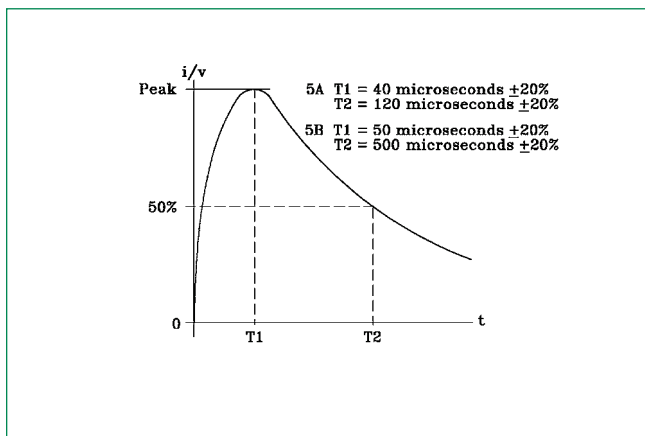

SMDJ-HRA Series

Surface Mount – 3000W

Pin Injection Protection Per RTCA/DO-160G

| Part Number (Uni) | Part Number (Bi) | 25C | | | | | | 70C | | | | | | 120C | | | | | |
|-------------------|------------------|--------|------|-------------------|------|--------------------|------|--------|------|-------------------|------|--------------------|------|--------|------|-------------------|------|--------------------|------|
| | | Wave 3 | | Wave 4 (6.4/69us) | | Wave 5a (40/120us) | | Wave 3 | | Wave 4 (6.4/69us) | | Wave 5a (40/120us) | | Wave 3 | | Wave 4 (6.4/69us) | | Wave 5a (40/120us) | |
| | | L5 | L3 | L4 | L5 | L3 | L4 | L5 | L3 | L4 | L5 | L3 | L4 | L5 | L3 | L4 | L5 | L3 | L4 |
| | | 128A | 60A | 150A | 320A | 300A | 750A | 128A | 60A | 150A | 320A | 300A | 750A | 128A | 60A | 150A | 320A | 300A | 750A |
| SMDJ5.0A-HRA | SMDJ5.0CA-HRA | pass | pass | pass | pass | pass | pass | pass | pass | pass | pass | pass | pass | pass | pass | pass | pass | pass | pass |
| SMDJ6.0A-HRA | SMDJ6.0CA-HRA | pass | pass | pass | pass | pass | pass | pass | pass | pass | pass | pass | pass | pass | pass | pass | pass | pass | pass |
| SMDJ6.5A-HRA | SMDJ6.5CA-HRA | pass | pass | pass | pass | pass | pass | pass | pass | pass | pass | pass | pass | pass | pass | pass | pass | pass | pass |
| SMDJ7.0A-HRA | SMDJ7.0CA-HRA | pass | pass | pass | pass | pass | pass | pass | pass | pass | pass | pass | pass | pass | pass | pass | pass | pass | pass |
| SMDJ7.5A-HRA | SMDJ7.5CA-HRA | pass | pass | pass | pass | pass | pass | pass | pass | pass | pass | pass | pass | pass | pass | pass | pass | pass | pass |
| SMDJ8.0A-HRA | SMDJ8.0CA-HRA | pass | pass | pass | pass | pass | pass | pass | pass | pass | pass | pass | pass | pass | pass | pass | pass | pass | pass |
| SMDJ8.5A-HRA | SMDJ8.5CA-HRA | pass | pass | pass | pass | pass | pass | pass | pass | pass | pass | pass | pass | pass | pass | pass | pass | pass | pass |
| SMDJ9.0A-HRA | SMDJ9.0CA-HRA | pass | pass | pass | pass | pass | pass | pass | pass | pass | pass | pass | pass | pass | pass | pass | pass | pass | pass |
| SMDJ10A-HRA | SMDJ10CA-HRA | pass | pass | pass | pass | pass | pass | pass | pass | pass | pass | pass | pass | pass | pass | pass | pass | pass | pass |
| SMDJ11A-HRA | SMDJ11CA-HRA | pass | pass | pass | pass | pass | - | pass | pass | pass | pass | pass | pass | pass | pass | pass | pass | pass | - |
| SMDJ12A-HRA | SMDJ12CA-HRA | pass | pass | pass | pass | pass | - | pass | pass | pass | pass | pass | pass | pass | pass | pass | pass | pass | - |
| SMDJ13A-HRA | SMDJ13CA-HRA | pass | pass | pass | pass | pass | - | pass | pass | pass | pass | pass | pass | pass | pass | pass | pass | pass | - |
| SMDJ14A-HRA | SMDJ14CA-HRA | pass | pass | pass | pass | pass | - | pass | pass | pass | pass | pass | pass | pass | pass | pass | pass | pass | - |
| SMDJ15A-HRA | SMDJ15CA-HRA | pass | pass | pass | pass | pass | - | pass | pass | pass | pass | pass | pass | pass | pass | pass | pass | pass | - |
| SMDJ16A-HRA | SMDJ16CA-HRA | pass | pass | pass | pass | pass | - | pass | pass | pass | pass | pass | pass | pass | pass | pass | pass | pass | - |
| SMDJ17A-HRA | SMDJ17CA-HRA | pass | pass | pass | pass | pass | - | pass | pass | pass | pass | pass | pass | pass | pass | pass | pass | pass | - |
| SMDJ18A-HRA | SMDJ18CA-HRA | pass | pass | pass | pass | pass | - | pass | pass | pass | pass | pass | pass | pass | pass | pass | pass | pass | - |
| SMDJ20A-HRA | SMDJ20CA-HRA | pass | pass | pass | pass | pass | - | pass | pass | pass | pass | pass | pass | pass | pass | pass | pass | pass | - |
| SMDJ22A-HRA | SMDJ22CA-HRA | pass | pass | pass | - | - | - | pass | pass | pass | - | - | - | pass | pass | pass | - | - | - |
| SMDJ24A-HRA | SMDJ24CA-HRA | pass | pass | pass | - | - | - | pass | pass | pass | - | - | - | pass | pass | pass | - | - | - |
| SMDJ26A-HRA | SMDJ26CA-HRA | pass | pass | pass | - | - | - | pass | pass | pass | - | - | - | pass | pass | pass | - | - | - |
| SMDJ28A-HRA | SMDJ28CA-HRA | pass | pass | pass | - | - | - | pass | pass | pass | - | - | - | pass | pass | pass | - | - | - |
| SMDJ30A-HRA | SMDJ30CA-HRA | pass | pass | pass | - | - | - | pass | pass | pass | - | - | - | pass | pass | pass | - | - | - |
| SMDJ33A-HRA | SMDJ33CA-HRA | pass | pass | pass | - | - | - | pass | pass | pass | - | - | - | pass | pass | pass | - | - | - |
| SMDJ36A-HRA | SMDJ36CA-HRA | pass | pass | pass | - | - | - | pass | pass | pass | - | - | - | pass | pass | pass | - | - | - |
| SMDJ40A-HRA | SMDJ40CA-HRA | pass | pass | pass | - | - | - | pass | pass | pass | - | - | - | pass | pass | pass | - | - | - |
| SMDJ43A-HRA | SMDJ43CA-HRA | pass | pass | pass | - | - | - | pass | pass | pass | - | - | - | pass | pass | - | - | - | - |
| SMDJ45A-HRA | SMDJ45CA-HRA | pass | pass | pass | - | - | - | pass | pass | - | - | - | - | pass | pass | - | - | - | - |
| SMDJ48A-HRA | SMDJ48CA-HRA | pass | pass | pass | - | - | - | pass | pass | - | - | - | - | pass | pass | - | - | - | - |
| SMDJ51A-HRA | SMDJ51CA-HRA | pass | pass | pass | - | - | - | pass | pass | - | - | - | - | pass | pass | - | - | - | - |
| SMDJ54A-HRA | SMDJ54CA-HRA | pass | pass | pass | - | - | - | pass | pass | - | - | - | - | pass | pass | - | - | - | - |
| SMDJ58A-HRA | - | pass | pass | - | - | - | - | pass | pass | - | - | - | - | pass | pass | - | - | - | - |
| SMDJ60A-HRA | SMDJ60CA-HRA | pass | pass | - | - | - | - | pass | pass | - | - | - | - | pass | pass | - | - | - | - |
| SMDJ64A-HRA | - | pass | pass | - | - | - | - | pass | pass | - | - | - | - | pass | - | - | - | - | - |
| SMDJ70A-HRA | - | pass | pass | - | - | - | - | pass | pass | - | - | - | - | pass | - | - | - | - | - |
| SMDJ75A-HRA | - | pass | pass | - | - | - | - | pass | pass | - | - | - | - | pass | - | - | - | - | - |
| SMDJ78A-HRA | - | pass | pass | - | - | - | - | pass | pass | - | - | - | - | pass | - | - | - | - | - |
| SMDJ85A-HRA | - | pass | pass | - | - | - | - | pass | pass | - | - | - | - | pass | - | - | - | - | - |
| SMDJ90A-HRA | - | pass | pass | - | - | - | - | pass | - | - | - | - | - | pass | - | - | - | - | - |
| SMDJ100A-HRA | - | pass | pass | - | - | - | - | pass | - | - | - | - | - | pass | - | - | - | - | - |
| SMDJ110A-HRA | - | pass | pass | - | - | - | - | pass | - | - | - | - | - | pass | - | - | - | - | - |
| SMDJ120A-HRA | - | pass | pass | - | - | - | - | pass | - | - | - | - | - | pass | - | - | - | - | - |
| SMDJ130A-HRA | - | pass | pass | - | - | - | - | pass | - | - | - | - | - | pass | - | - | - | - | - |
| SMDJ150A-HRA | - | pass | pass | - | - | - | - | pass | - | - | - | - | - | pass | - | - | - | - | - |
| SMDJ170A-HRA | - | pass | pass | - | - | - | - | pass | - | - | - | - | - | pass | - | - | - | - | - |

Note:

1. L1 = Level 1, L2 = Level 2, L3 = Level 3, L4 = Level 4, L5 = Level 5

Disclaimer Notice - Information furnished is believed to be accurate and reliable. However, users should independently evaluate the suitability of and test each product selected for their own applications. Littelfuse products are not designed for, and may not be used in, all applications. Read complete Disclaimer Notice at <http://www.littelfuse.com/disclaimer-electronics>.

Looking for pricing, stock, or lifecycle information?

Click below to explore more details on WIN SOURCE:

 [View SMDJ90A-HRA on WIN SOURCE](#)

 [Littelfuse Inc. Information](#)

Optimize Your Supply Chain with WIN SOURCE Solutions

-  Global Sourcing Solution
-  Obsolete Management
-  Cost Control Management
-  Shortage Management
-  Alternative Solution
-  Excess Inventory Management