



THE DATASHEET OF SMBJ43



Transient Voltage Suppressors DO-214AA/SMB Package

SMBJ Series

MERITEK

FEATURE

- Breakdown Voltage from 5.0 to 440V
- 600W peak pulse power capability with a 10/1000 μ s waveform, repetitive rate (duty cycle): 0.01%
- Glass passivated chip
- Excellent clamping capability, fast response time.
- Low incremental surge resistance, Low profile package
- Terminal: Solderable per MIL-STD-750, Method 2026
- Epoxy: UL 94V-0 rate flame retardant
- UL/cUL safety approved: certification No: E223045



ELECTRICAL CHARACTERISTICS



Parameter	Symbols	Value	Unit
Peak power dissipation with a 10/1000 μ s waveform(1)	P_{PP}	600	Watts
Peak pulse current with a 10/1000 μ s waveform(1)	I_{PP}	See Next Table	Amps
Power dissipation on infinite heatsink at $T_L = 75^\circ\text{C}$	P_D	5.0	Watts
Peak forward surge current, 8.3 ms single half sine-wave unidirectional only. Measured on 8.3 ms single half sine-wave or equivalent square wave, duty cycle = 4 pulses per minute maximum.	I_{FSM}	100	Amps
Maximum instantaneous forward voltage at 25 A for unidirectional only. $V_F < 3.5\text{V}$ for devices of $V_{BR} < 200\text{V}$ and $V_F < 5.0\text{V}$ for devices of $V_{BR} > 201\text{V}$	V_F	3.5/5.0	Volts
Operating junction and storage temperature range	T_J, T_{STG}	-55 to +150	$^\circ\text{C}$

Rating at 25 $^\circ\text{C}$, ambient temperature unless otherwise specified. Single phase, half wave, 60 Hz, resistive or inductive load. For capacitive load, derate current by 20%.

1. Non-repetitive current pulse per Fig.5 and derated above $T_A = 25^\circ\text{C}$ per Fig.1

DIMENSIONS

Item	DO-214AA(SMB)	
	Millimeters	
	Min.	Max.
W	4.02	4.85
A	1.91	2.20
B	3.26	3.94
C	2.11	2.44
D	0.76	1.52
E	5.08	5.59
F	-	0.203
G	0.152	0.305

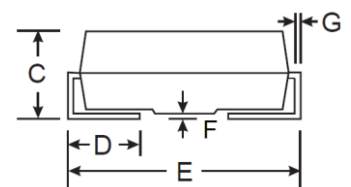
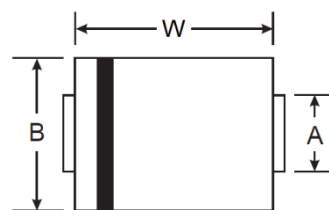

SOLDERING PAD LAYOUT

A	B	C	D	E
2.3	4.3	6.7	1.8	2.5

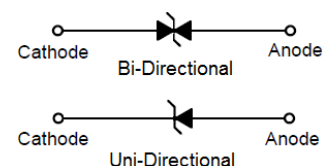
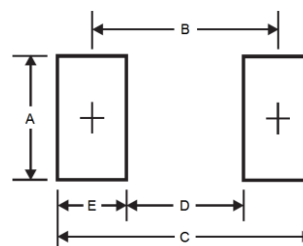

Transient Voltage Suppressors DO-214AA/SMB Package

SMBJ Series

MERITEK

ELECTRICAL CHARACTERISTICS(Continued)

Device Type (Uni)	Device Type (Bi)	Marking Code		Breakdown Voltage VBR@IT			Working Peak Reverse Voltage VRWM(V)	Maximum Reverse Leakage IR @ VRWM(V)	Maximum Reverse Surge Current Ipp(A)	Maximum Clamping Voltage VC@Ipp
		Uni	Bi	Min(V)	Max(V)	IT(mA)				
SMBJ5.0	SMBJ5.0C	KD	AD	6.40	7.30	10	5.0	800	62.50	9.6
SMBJ5.0A	SMBJ5.0CA	KE	AE	6.40	7.00	10	5.0	800	65.22	9.2
SMBJ6.0	SMBJ6.0C	KF	AF	6.67	8.15	10	6.0	800	52.63	11.4
SMBJ6.0A	SMBJ6.0CA	KG	AG	6.67	7.37	10	6.0	800	58.25	10.3
SMBJ6.5	SMBJ6.5C	KH	AH	7.22	8.82	10	6.5	500	48.78	12.3
SMBJ6.5A	SMBJ6.5CA	KK	AK	7.22	7.98	10	6.5	500	53.57	11.2
SMBJ7.0	SMBJ7.0C	KL	AL	7.78	9.51	10	7.0	200	45.11	13.3
SMBJ7.0A	SMBJ7.0CA	KM	AM	7.78	8.60	10	7.0	200	50.00	12.0
SMBJ7.5	SMBJ7.5C	KN	AN	8.33	10.20	1	7.5	100	41.96	14.3
SMBJ7.5A	SMBJ7.5CA	KP	AP	8.33	9.21	1	7.5	100	46.51	12.9
SMBJ8.0	SMBJ8.0C	KQ	AQ	8.89	10.90	1	8.0	50	40.00	15.0
SMBJ8.0A	SMBJ8.0CA	KR	AR	8.89	9.83	1	8.0	50	44.12	13.6
SMBJ8.5	SMBJ8.5C	KS	AS	9.44	11.50	1	8.5	10	37.74	15.9
SMBJ8.5A	SMBJ8.5CA	KT	AT	9.44	10.40	1	8.5	10	41.67	14.4
SMBJ9.0	SMBJ9.0C	KU	AU	10.00	12.20	1	9.0	5	35.50	16.9
SMBJ9.0A	SMBJ9.0CA	KV	AV	10.00	11.10	1	9.0	5	38.96	15.4
SMBJ10	SMBJ10C	KW	AW	11.10	13.60	1	10.0	5	31.91	18.8
SMBJ10A	SMBJ10CA	KX	AX	11.10	12.30	1	10.0	5	35.29	17.0
SMBJ11	SMBJ11C	KY	AY	12.20	14.90	1	11.0	5	29.85	20.1
SMBJ11A	SMBJ11CA	KZ	AZ	12.20	13.50	1	11.0	5	32.97	18.2
SMBJ12	SMBJ12C	LD	BD	13.30	16.30	1	12.0	5	27.27	22.0
SMBJ12A	SMBJ12CA	LE	BE	13.30	14.70	1	12.0	5	30.15	19.9
SMBJ13	SMBJ13C	LF	BF	14.40	17.60	1	13.0	5	25.21	23.8
SMBJ13A	SMBJ13CA	LG	BG	14.40	15.90	1	13.0	5	27.91	21.5
SMBJ14	SMBJ14C	LH	BH	15.60	19.10	1	14.0	5	23.26	25.8
SMBJ14A	SMBJ14CA	LK	BK	15.60	17.20	1	14.0	5	25.86	23.2
SMBJ15	SMBJ15C	LL	BL	16.70	20.40	1	15.0	5	22.30	26.9
SMBJ15A	SMBJ15CA	LM	BM	16.70	18.50	1	15.0	5	24.59	24.4
SMBJ16	SMBJ16C	LN	BN	17.80	21.80	1	16.0	5	20.83	28.8
SMBJ16A	SMBJ16CA	LP	BP	17.80	19.70	1	16.0	5	23.08	26.0
SMBJ17	SMBJ17C	LQ	BQ	18.90	23.10	1	17.0	5	19.67	30.5
SMBJ17A	SMBJ17CA	LR	BR	18.90	20.90	1	17.0	5	21.74	27.6
SMBJ18	SMBJ18C	LS	BS	20.00	24.40	1	18.0	5	18.63	32.2
SMBJ18A	SMBJ18CA	LT	BT	20.00	22.10	1	18.0	5	20.55	29.2
SMBJ19	SMBJ19C	LA	BA	21.10	25.76	1	19.0	5	17.64	34.0
SMBJ19A	SMBJ19CA	LB	BB	21.10	23.30	1	19.0	5	19.49	30.8
SMBJ20	SMBJ20C	LU	BU	22.20	27.10	1	20.0	5	16.76	35.8
SMBJ20A	SMBJ20CA	LV	BV	22.20	24.50	1	20.0	5	18.52	32.4
SMBJ22	SMBJ22C	LW	BW	24.40	29.80	1	22.0	5	15.23	39.4
SMBJ22A	SMBJ22CA	LX	BX	24.40	26.90	1	22.0	5	16.90	35.5
SMBJ24	SMBJ24C	LY	BY	26.70	32.60	1	24.0	5	13.95	43.0
SMBJ24A	SMBJ24CA	LZ	BZ	26.70	29.50	1	24.0	5	15.42	38.9
SMBJ26	SMBJ26C	MD	CD	28.90	35.30	1	26.0	5	12.88	46.6
SMBJ26A	SMBJ26CA	ME	CE	28.90	31.90	1	26.0	5	14.25	42.1
SMBJ28	SMBJ28C	MF	CF	31.10	38.00	1	28.0	5	12.00	50.0
SMBJ28A	SMBJ28CA	MG	CG	31.10	34.40	1	28.0	5	13.22	45.4
SMBJ30	SMBJ30C	MH	CH	33.30	40.70	1	30.0	5	11.21	53.5
SMBJ30A	SMBJ30CA	MK	CK	33.30	36.80	1	30.0	5	12.40	48.4
SMBJ33	SMBJ33C	ML	CL	36.70	44.90	1	33.0	5	10.17	59.0

Transient Voltage Suppressors DO-214AA/SMB Package

SMBJ Series

MERITEK

ELECTRICAL CHARACTERISTICS(Continued)

Device Type (Uni)	Device Type (Bi)	Marking Code		Breakdown Voltage VBR@IT			Working Peak Reverse Voltage VRWM(V)	Maximum Reverse Leakage IR @ VRWM(V)	Maximum Reverse Surge Current Ipp(A)	Maximum Clamping Voltage VC@Ipp
		Uni	Bi	Min(V)	Max(V)	IT(mA)				
SMBJ33A	SMBJ33CA	MM	CM	36.70	40.60	1	33.0	5	11.26	53.3
SMBJ36	SMBJ36C	MN	CN	40.00	48.90	1	36.0	5	9.33	64.3
SMBJ36A	SMBJ36CA	MP	CP	40.00	44.20	1	36.0	5	10.33	58.1
SMBJ40	SMBJ40C	MQ	CQ	44.40	54.30	1	40.0	5	8.40	71.4
SMBJ40A	SMBJ40CA	MR	CR	44.40	49.10	1	40.0	5	9.30	64.5
SMBJ43	SMBJ43C	MS	CS	47.80	58.40	1	43.0	5	7.82	76.7
SMBJ43A	SMBJ43CA	MT	CT	47.80	52.80	1	43.0	5	8.65	69.4
SMBJ45	SMBJ45C	MU	CU	50.00	61.10	1	45.0	5	7.47	80.3
SMBJ45A	SMBJ45CA	MV	CV	50.00	55.30	1	45.0	5	8.25	72.7
SMBJ48	SMBJ48C	MW	CW	53.30	65.10	1	48.0	5	7.02	85.5
SMBJ48A	SMBJ48CA	MX	CX	53.30	58.90	1	48.0	5	7.75	77.4
SMBJ51	SMBJ51C	MY	CY	56.70	69.30	1	51.0	5	6.59	91.1
SMBJ51A	SMBJ51CA	MZ	CZ	56.70	62.70	1	51.0	5	7.28	82.4
SMBJ54	SMBJ54C	ND	DD	60.00	73.30	1	54.0	5	6.23	96.3
SMBJ54A	SMBJ54CA	NE	DE	60.00	66.30	1	54.0	5	6.89	87.1
SMBJ58	SMBJ58C	NF	DF	64.40	78.70	1	58.0	5	5.83	103.0
SMBJ58A	SMBJ58CA	NG	DG	64.40	71.20	1	58.0	5	6.41	93.6
SMBJ60	SMBJ60C	NH	DH	66.70	81.50	1	60.0	5	5.61	107.0
SMBJ60A	SMBJ60CA	NK	DK	66.70	73.70	1	60.0	5	6.20	96.8
SMBJ64	SMBJ64C	NL	DL	71.10	86.90	1	64.0	5	5.26	114.0
SMBJ64A	SMBJ64CA	NM	DM	71.10	78.60	1	64.0	5	5.83	103.0
SMBJ70	SMBJ70C	NN	DN	77.80	95.10	1	70.0	5	4.80	125.0
SMBJ70A	SMBJ70CA	NP	DP	77.80	86.00	1	70.0	5	5.31	113.0
SMBJ75	SMBJ75C	NQ	DQ	83.30	102.00	1	75.0	5	4.48	134.0
SMBJ75A	SMBJ75CA	NR	DR	83.30	92.10	1	75.0	5	4.96	121.0
SMBJ78	SMBJ78C	NS	DS	86.70	106.00	1	78.0	5	4.32	139.0
SMBJ78A	SMBJ78CA	NT	DT	86.70	95.80	1	78.0	5	4.76	126.0
SMBJ80	SMBJ80C	NA	DA	88.96	108.80	1	80.0	5	4.19	143.2
SMBJ80A	SMBJ80CA	NB	DB	88.80	97.60	1	80.0	5	4.63	129.6
SMBJ85	SMBJ85C	NU	DU	94.40	115.00	1	85.0	5	3.97	151.0
SMBJ85A	SMBJ85CA	NV	DV	94.40	104.00	1	85.0	5	4.38	137.0
SMBJ90	SMBJ90C	NW	DW	100.00	122.00	1	90.0	5	3.75	160.0
SMBJ90A	SMBJ90CA	NX	DX	100.00	111.00	1	90.0	5	4.11	146.0
SMBJ100	SMBJ100C	NY	DY	111.00	136.00	1	100.0	5	3.35	179.0
SMBJ100A	SMBJ100CA	NZ	DZ	111.00	123.00	1	100.0	5	3.70	162.0
SMBJ110	SMBJ110C	PD	ED	122.00	149.00	1	110.0	5	3.06	196.0
SMBJ110A	SMBJ110CA	PE	EE	122.00	135.00	1	110.0	5	3.39	177.0
SMBJ120	SMBJ120C	PF	EF	133.00	163.00	1	120.0	5	2.80	214.0
SMBJ120A	SMBJ120CA	PG	EG	133.00	147.00	1	120.0	5	3.11	193.0
SMBJ130	SMBJ130C	PH	EH	144.00	176.00	1	130.0	5	2.60	231.0
SMBJ130A	SMBJ130CA	PK	EK	144.00	159.00	1	130.0	5	2.87	209.0
SMBJ140	SMBJ140C	PA	EA	155.68	190.40	1	140.0	5	2.39	250.6
SMBJ140A	SMBJ140CA	PB	EB	155.00	171.00	1	140.0	5	2.65	226.8
SMBJ150	SMBJ150C	PL	EL	167.00	204.00	1	150.0	5	2.24	268.0
SMBJ150A	SMBJ150CA	PM	EM	167.00	185.00	1	150.0	5	2.47	243.0
SMBJ160	SMBJ160C	PN	EN	178.00	218.00	1	160.0	5	2.09	287.0
SMBJ160A	SMBJ160CA	PP	EP	178.00	197.00	1	160.0	5	2.32	259.0
SMBJ170	SMBJ170C	PQ	EQ	189.00	231.00	1	170.0	5	1.97	304.0
SMBJ170A	SMBJ170CA	PR	ER	189.00	209.00	1	170.0	5	2.18	275.0

Transient Voltage Suppressors DO-214AA/SMB Package

SMBJ Series

MERITEK

ELECTRICAL CHARACTERISTICS(Continued)

Device Type (Uni)	Device Type (Bi)	Marking Code		Breakdown Voltage VBR@IT			Working Peak Reverse Voltage VRWM(V)	Maximum Reverse Leakage IR @ VRWM(V)	Maximum Reverse Surge Current Ipp(A)	Maximum Clamping Voltage VC@Ipp
		Uni	Bi	Min(V)	Max(V)	IT(mA)				
SMBJ180	SMBJ180C	PS	ES	200.16	244.80	1	180.0	5	1.86	322.2
SMBJ180A	SMBJ180C A	PT	ET	200.00	220.00	1	180.0	5	2.06	291.6
SMBJ190	SMBJ190C	PU	EU	211.00	258.00	1	190.0	5	1.76	340.1
SMBJ190A	SMBJ190C A	PV	EV	211.00	232.00	1	190.0	5	1.95	307.8
SMBJ200A	SMBJ200C A	PW	EW	224.00	247.00	1	200.0	5	1.85	324.0
SMBJ220A	SMBJ220C A	PX	EX	246.00	272.00	1	220.0	5	1.69	356.0
SMBJ250A	SMBJ250C A	PZ	EZ	279.00	309.00	1	250.0	5	1.48	405.0
SMBJ300A	SMBJ300C A	QE	FE	335.00	371.00	1	300.0	5	1.23	486.0
SMBJ350A	SMBJ350C A	QG	FG	391.00	432.00	1	350.0	5	1.06	567.0
SMBJ400A	SMBJ400C A	QK	FK	447.00	494.00	1	400.0	5	0.93	648.0
SMBJ440A	SMBJ440C A	QM	FM	492.00	543.00	1	440.0	5	0.84	713.0

CHARACTERISTICS CURVES

Fig.1 Pulse Derating Curve

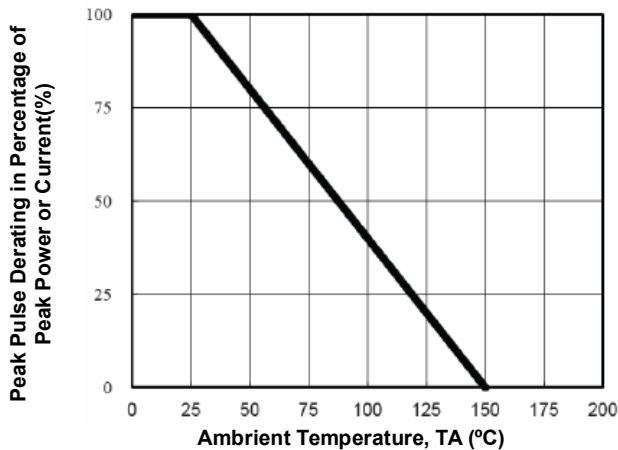

Fig 2. Maximum Non-Repetitive Surge Current

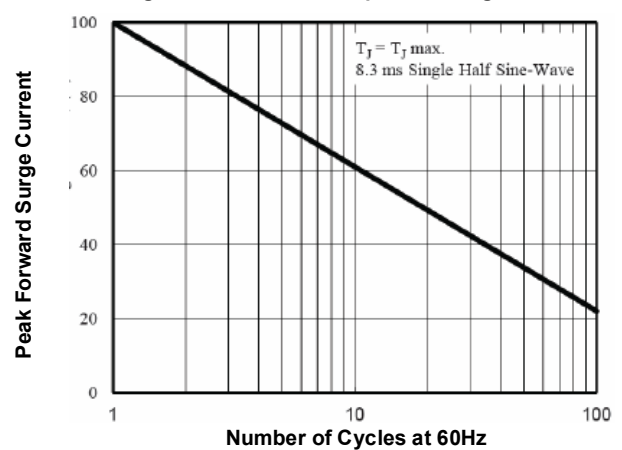

Fig 3. Steady State Power Derating Curve

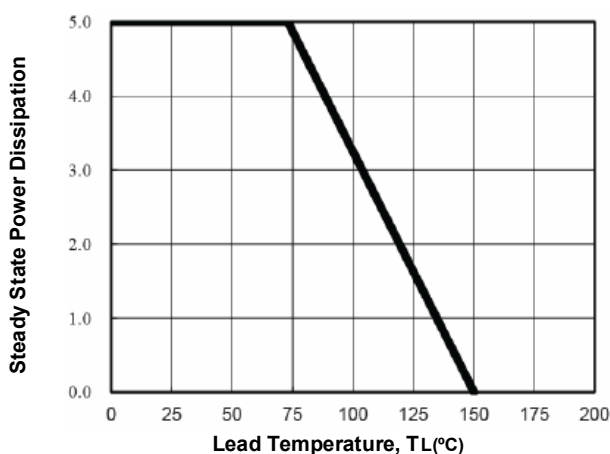
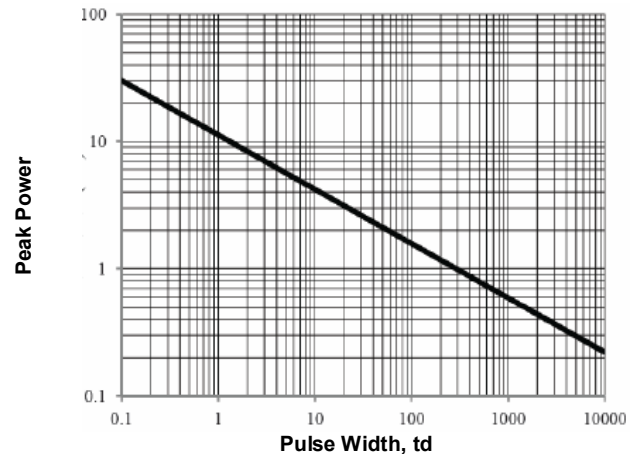

Fig 4. Peak Pulse Power Rating Curve



CHARACTERISTICS CURVES(Continued)

Fig 5. Pulse Waveform

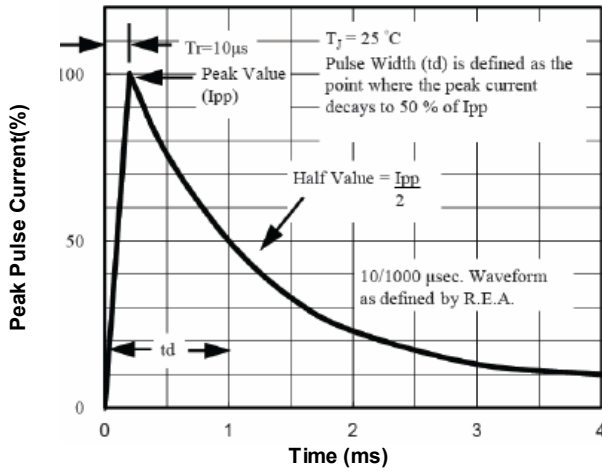
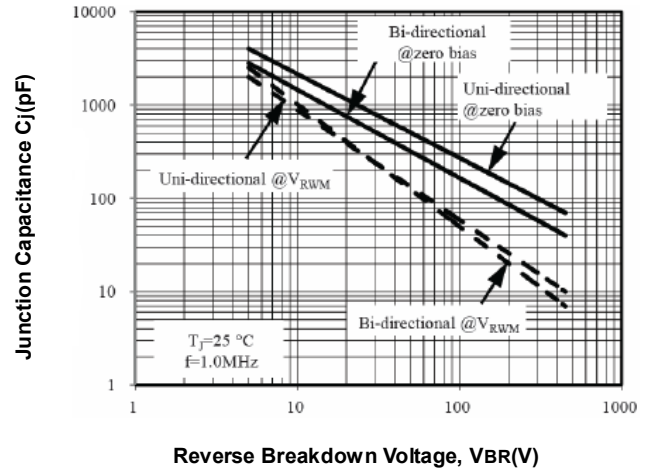
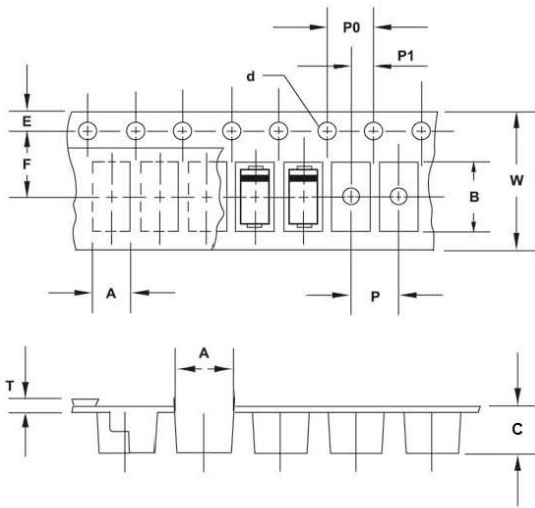

Fig 6. Typical Junction Capacitance



PACKAGING SPECIFICATION- DO214AA (SMB) - Tape Carrier and Reel



DO-214AA(SMB) - Tape carrier

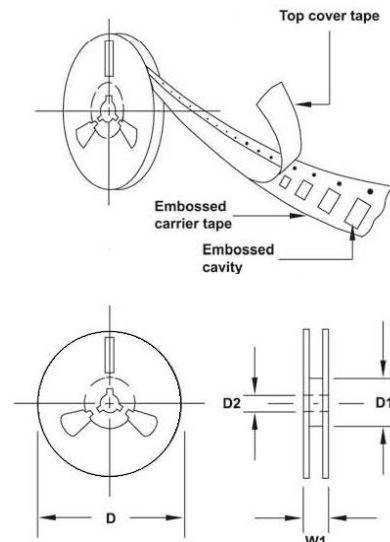

DO-214AA(SMB) - Reel

Item	Symbol	DO-214AC (SMB)	Item	Symbol	DO-214AC (SMB)
Carrier width	A	3.77 ± 0.10	Punch hole position	F	5.50 ± 0.05
Carrier length	B	5.70 ± 0.10	Punch hole pitch	P	8.00 ± 0.10
Carrier depth	C	2.40 ± 0.10	Sprocket hole pitch	P0	4.00 ± 0.10
Sprocket hole	d	1.55 ± 0.10	Embossment center	P1	2.00 ± 0.05
Reel outside diameter	D	330.0 ± 2.0	Overall tape thickness	T	Max 0.4
Reel inner diameter	D1	Min 50	Tape width	W	12.00 ± 0.30
Feed hole diameter	D2	13.00 ± 0.50	Reel width	W1	Max 18.40
Sprocket hole position	E	1.75 ± 0.10			

Unit: mm

Transient Voltage Suppressors DO-214AA/SMB Package

SMBJ Series

MERITEK

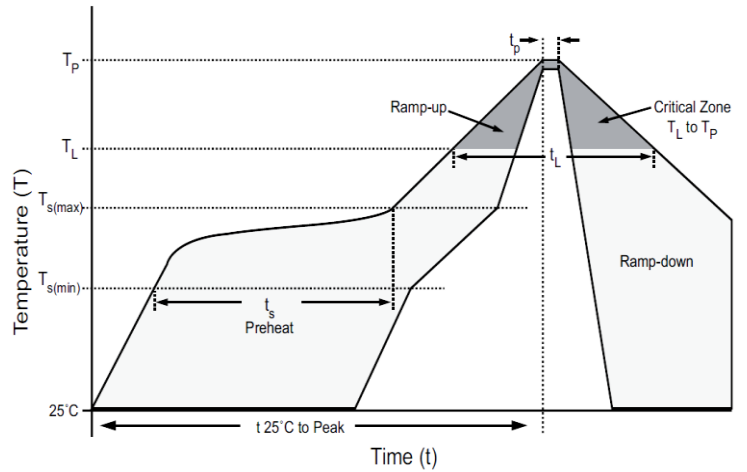

RECOMMENDED SOLDERING PROFILES

Reflow Condition		
Average Ramp-up Rate T_L to T_P		3°C/second max.
Pre Heat	Temp. Min $T_{s(min)}$	150°C
	Tempe. Max $T_{s(max)}$	200°C
	Time (min. to max.) (t_s)	60-120 seconds
Ramp-up Rate $T_{s(max)}$ to T_L		3°C/second max.
Reflow	Temp. (T_L)	217°C
	Time (t_L)	60-260 seconds
Peak Temperature (T_P)		255 ^{-0/+5} °C
Time within 5°C of actual peak Temperature (t_p)		10-30 seconds
Ramp-down Rate		6°C/second max.
Time 25°C to peak Temp. (T_P)		6 minutes max.



Looking for pricing, stock, or lifecycle information?

Click below to explore more details on WIN SOURCE:

-  [View SMBJ43 on WIN SOURCE](#)
-  [Meritek Information](#)

Optimize Your Supply Chain with WIN SOURCE Solutions

-  Global Sourcing Solution
-  Obsolete Management
-  Cost Control Management
-  Shortage Management
-  Alternative Solution
-  Excess Inventory Management