



THE DATASHEET OF SMCJ15C



Transient Voltage Suppressors DO-214AB/SMC Package

SMCJ Series

MERITEK

FEATURE

- Breakdown Voltage from 5.0 to 440V
- 1500W peak pulse power capability with a 10/1000 μ s waveform, repetitive rate (duty cycle): 0.01%
- Glass passivated chip
- Excellent clamping capability, fast response time.
- Low incremental surge resistance, Low profile package
- Terminal: Solderable per MIL-STD-750, Method 2026
- Epoxy: UL 94V-0 rate flame retardant
- UL/cUL safety approved: certification No: E223045



ELECTRICAL CHARACTERISTICS



Parameter	Symbols	Value	Unit
Peak power dissipation with a 10/1000 μ s waveform(1)	P_{PP}	1500	Watts
Peak pulse current with a 10/1000 μ s waveform(1)	I_{PP}	See Next Table	Amps
Power dissipation on infinite heatsink at TL = 75 °C	P_D	6.5	Watts
Peak forward surge current, 8.3 ms single half sine-wave unidirectional only. Measured on 8.3 ms single half sine-wave or equivalent square wave, duty cycle = 4 pulses per minute maximum.	I_{FSM}	200	Amps
Maximum instantaneous forward voltage at 25 A for unidirectional only. $V_F < 3.5V$ for devices of $V_{BR} < 200V$ and $V_F < 5.0V$ for devices of $V_{BR} > 201V$	V_F	3.5/5.0	Volts
Operating junction and storage temperature range	T_J, T_{STG}	-55 to +150	°C

Rating at 25°C, ambient temperature unless otherwise specified. Single phase, half wave, 60 Hz, resistive or inductive load.
For capacitive load, derate current by 20%.

1.Non-repetitive current pulse per Fig.5 and derated above $T_A=25^\circ C$ per Fig.1

DIMENSIONS

Item	DO-214AB(SMC)	
	Milimeters	
	Min.	Max.
W	6.52	7.11
A	2.75	3.25
B	5.52	6.22
C	2.00	2.62
D	0.76	1.52
E	7.64	8.13
F	-	0.203
G	0.152	0.305

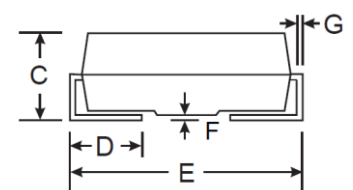
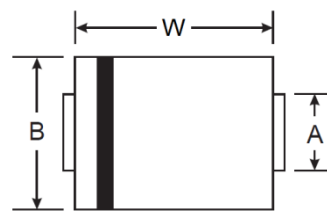

SOLDERING PAD LAYOUT

A	B	C	D	E
3.3	6.9	9.3	4.4	2.5

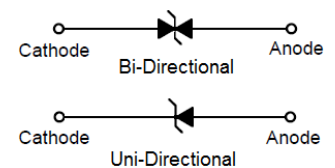
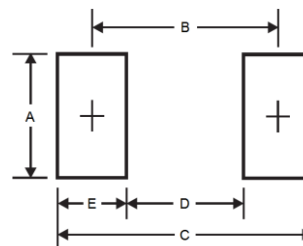

Transient Voltage Suppressors DO-214AB/SMC Package

SMCJ Series

MERITEK

ELECTRICAL CHARACTERISTICS(Continued)

Device Type (Uni)	Device Type (Bi)	Marking Code		Breakdown Voltage VBR@IT			Working Peak Reverse Voltage VRWM(V)	Maximum Reverse Leakage IR @ VRWM(V)	Maximum Reverse Surge Current Ipp(A)	Maximum Clamping Voltage VC@Ipp
		Uni	Bi	Min(V)	Max(V)	IT(mA)				
SMCJ5.0	SMCJ5.0C	GDD	BDD	6.40	7.30	10	5.0	1000	156.25	9.6
SMCJ5.0A	SMCJ5.0CA	GDE	BDE	6.40	7.00	10	5.0	1000	163.04	9.2
SMCJ6.0	SMCJ6.0C	GDF	BDF	6.67	8.15	10	6.0	1000	131.58	11.4
SMCJ6.0A	SMCJ6.0CA	GDG	BDG	6.67	7.37	10	6.0	1000	145.63	10.3
SMCJ6.5	SMCJ6.5C	GDH	BDH	7.22	8.82	10	6.5	500	121.95	12.3
SMCJ6.5A	SMCJ6.5CA	GDK	BDK	7.22	7.98	10	6.5	500	133.93	11.2
SMCJ7.0	SMCJ7.0C	GDL	BDL	7.78	9.51	10	7.0	200	112.78	13.3
SMCJ7.0A	SMCJ7.0CA	GDM	BDM	7.78	8.60	10	7.0	200	125.00	12.0
SMCJ7.5	SMCJ7.5C	GDN	BDN	8.33	10.20	1	7.5	100	104.90	14.3
SMCJ7.5A	SMCJ7.5CA	GDP	BDP	8.33	9.21	1	7.5	100	116.28	12.9
SMCJ8.0	SMCJ8.0C	GDQ	BDQ	8.89	10.90	1	8.0	50	100.00	15.0
SMCJ8.0A	SMCJ8.0CA	GDR	BDR	8.89	9.83	1	8.0	50	110.29	13.6
SMCJ8.5	SMCJ8.5C	GDS	BDS	9.44	11.50	1	8.5	20	94.34	15.9
SMCJ8.5A	SMCJ8.5CA	GDT	BDT	9.44	10.40	1	8.5	20	104.17	14.4
SMCJ9.0	SMCJ9.0C	GDU	BDU	10.00	12.20	1	9.0	10	88.76	16.9
SMCJ9.0A	SMCJ9.0CA	GDV	BDV	10.00	11.10	1	9.0	10	97.40	15.4
SMCJ10	SMCJ10C	GDW	BDW	11.10	13.60	1	10.0	5	79.79	18.8
SMCJ10A	SMCJ10CA	GDX	BDX	11.10	12.30	1	10.0	5	88.24	17.0
SMCJ11	SMCJ11C	GDY	BDY	12.20	14.90	1	11.0	5	74.63	20.1
SMCJ11A	SMCJ11CA	GDZ	BDZ	12.20	13.50	1	11.0	5	82.42	18.2
SMCJ12	SMCJ12C	GED	BED	13.30	16.30	1	12.0	5	68.18	22.0
SMCJ12A	SMCJ12CA	GEE	BEE	13.30	14.70	1	12.0	5	75.38	19.9
SMCJ13	SMCJ13C	GEF	BEF	14.40	17.60	1	13.0	5	63.03	23.8
SMCJ13A	SMCJ13CA	GEG	BEG	14.40	15.90	1	13.0	5	69.77	21.5
SMCJ14	SMCJ14C	GEH	BEH	15.60	19.10	1	14.0	5	58.14	25.8
SMCJ14A	SMCJ14CA	GEK	BEK	15.60	17.20	1	14.0	5	64.66	23.2
SMCJ15	SMCJ15C	GEL	BEL	16.70	20.40	1	15.0	5	55.76	26.9
SMCJ15A	SMCJ15CA	GEM	BEM	16.70	18.50	1	15.0	5	61.48	24.4
SMCJ16	SMCJ16C	GEN	BEN	17.80	21.80	1	16.0	5	52.08	28.8
SMCJ16A	SMCJ16CA	GEP	BEP	17.80	19.70	1	16.0	5	57.69	26.0
SMCJ17	SMCJ17C	GEQ	BEQ	18.90	23.10	1	17.0	5	49.18	30.5
SMCJ17A	SMCJ17CA	GER	BER	18.90	20.90	1	17.0	5	54.35	27.6
SMCJ18	SMCJ18C	GES	BES	20.00	24.40	1	18.0	5	46.58	32.2
SMCJ18A	SMCJ18CA	GET	BET	20.00	22.10	1	18.0	5	51.37	29.2
SMCJ19	SMCJ19C	GEA	BEA	21.13	25.76	1	19.0	5	44.10	34.0
SMCJ19A	SMCJ19CA	GEB	BEB	21.10	23.30	1	19.0	5	48.73	30.8
SMCJ20	SMCJ20C	GEU	BEU	22.20	27.10	1	20.0	5	41.90	35.8
SMCJ20A	SMCJ20CA	GEV	BEV	22.20	24.50	1	20.0	5	46.30	32.4
SMCJ22	SMCJ22C	GEW	BEW	24.40	29.80	1	22.0	5	38.07	39.4
SMCJ22A	SMCJ22CA	GEX	BEX	24.40	26.90	1	22.0	5	42.25	35.5
SMCJ24	SMCJ24C	GEY	BEY	26.70	32.60	1	24.0	5	34.88	43.0
SMCJ24A	SMCJ24CA	GEZ	BEZ	26.70	29.50	1	24.0	5	38.56	38.9
SMCJ26	SMCJ26C	GFD	BFD	28.90	35.30	1	26.0	5	32.19	46.6
SMCJ26A	SMCJ26CA	GFE	BFE	28.90	31.90	1	26.0	5	35.63	42.1
SMCJ28	SMCJ28C	GFF	BFF	31.10	38.00	1	28.0	5	30.00	50.0
SMCJ28A	SMCJ28CA	GFG	BFG	31.10	34.40	1	28.0	5	33.04	45.4
SMCJ30	SMCJ30C	GFH	BFH	33.30	40.70	1	30.0	5	28.04	53.5
SMCJ30A	SMCJ30CA	GFK	BFK	33.30	36.80	1	30.0	5	30.99	48.4
SMCJ33	SMCJ33C	GFL	BFL	36.70	44.90	1	33.0	5	25.42	59.0

Transient Voltage Suppressors DO-214AB/SMC Package

SMCJ Series

MERITEK

ELECTRICAL CHARACTERISTICS(Continued)

Device Type (Uni)	Device Type (Bi)	Marking Code		Breakdown Voltage VBR@IT			Working Peak Reverse Voltage VRWM(V)	Maximum Reverse Leakage IR @ VRWM(V)	Maximum Reverse Surge Current Ipp(A)	Maximum Clamping Voltage VC@Ipp
		Uni	Bi	Min(V)	Max(V)	IT(mA)				
SMCJ33A	SMCJ33CA	GFM	BFM	36.70	40.60	1	33.0	5	28.14	53.3
SMCJ36	SMCJ36C	GFN	BFN	40.00	48.90	1	36.0	5	23.33	64.3
SMCJ36A	SMCJ36CA	GFP	BFP	40.00	44.20	1	36.0	5	25.82	58.1
SMCJ40	SMCJ40C	GFQ	BFQ	44.40	54.30	1	40.0	5	21.01	71.4
SMCJ40A	SMCJ40CA	GFR	BFR	44.40	49.10	1	40.0	5	23.26	64.5
SMCJ43	SMCJ43C	GFS	BFS	47.80	58.40	1	43.0	5	19.56	76.7
SMCJ43A	SMCJ43CA	GFT	BFT	47.80	52.80	1	43.0	5	21.61	69.4
SMCJ45	SMCJ45C	GFU	BFU	50.00	61.10	1	45.0	5	18.68	80.3
SMCJ45A	SMCJ45CA	GFV	BFV	50.00	55.30	1	45.0	5	20.63	72.7
SMCJ48	SMCJ48C	GFW	BFW	53.30	65.10	1	48.0	5	17.54	85.5
SMCJ48A	SMCJ48CA	GFX	BFX	53.30	58.90	1	48.0	5	19.38	77.4
SMCJ51	SMCJ51C	GFY	BFY	56.70	69.30	1	51.0	5	16.47	91.1
SMCJ51A	SMCJ51CA	GFZ	BFZ	56.70	62.70	1	51.0	5	18.20	82.4
SMCJ54	SMCJ54C	GGD	BGD	60.00	73.30	1	54.0	5	15.58	96.3
SMCJ54A	SMCJ54CA	GGE	BGE	60.00	66.30	1	54.0	5	17.22	87.1
SMCJ58	SMCJ58C	GGF	BGF	64.40	78.70	1	58.0	5	14.56	103.0
SMCJ58A	SMCJ58CA	GGG	BGG	64.40	71.20	1	58.0	5	16.03	93.6
SMCJ60	SMCJ60C	GGH	BGH	66.70	81.50	1	60.0	5	14.02	107.0
SMCJ60A	SMCJ60CA	GGK	BGK	66.70	73.70	1	60.0	5	15.50	96.8
SMCJ64	SMCJ64C	GGL	BGL	71.10	86.90	1	64.0	5	13.16	114.0
SMCJ64A	SMCJ64CA	GGM	BGM	71.10	78.60	1	64.0	5	14.56	103.0
SMCJ70	SMCJ70C	GGN	BGN	77.80	95.10	1	70.0	5	12.00	125.0
SMCJ70A	SMCJ70CA	GGP	BGP	77.80	86.00	1	70.0	5	13.27	113.0
SMCJ75	SMCJ75C	GGQ	BGQ	83.30	102.00	1	75.0	5	11.19	134.0
SMCJ75A	SMCJ75CA	GGR	BGR	83.30	92.10	1	75.0	5	12.40	121.0
SMCJ78	SMCJ78C	GGS	BGS	86.70	106.00	1	78.0	5	10.79	139.0
SMCJ78A	SMCJ78CA	GGT	BGT	86.70	95.80	1	78.0	5	11.90	126.0
SMCJ80	SMCJ80C	GGA	BGA	88.96	108.80	1	80.0	5	10.47	143.2
SMCJ80A	SMCJ80CA	GGB	BGB	88.80	97.60	1	80.0	5	11.57	129.6
SMCJ85	SMCJ85C	GGU	BGU	94.40	115.00	1	85.0	5	9.93	151.0
SMCJ85A	SMCJ85CA	GGV	BGV	94.40	104.00	1	85.0	5	10.95	137.0
SMCJ90	SMCJ90C	GGW	BGW	100.00	122.00	1	90.0	5	9.38	160.0
SMCJ90A	SMCJ90CA	GGX	BGX	100.00	111.00	1	90.0	5	10.27	146.0
SMCJ100	SMCJ100C	GGY	BGY	111.00	136.00	1	100.0	5	8.38	179.0
SMCJ100A	SMCJ100CA	GGZ	BGZ	111.00	123.00	1	100.0	5	9.26	162.0
SMCJ110	SMCJ110C	GHD	BHD	122.00	149.00	1	110.0	5	7.65	196.0
SMCJ110A	SMCJ110CA	GHE	BHE	122.00	135.00	1	110.0	5	8.47	177.0
SMCJ120	SMCJ120C	GHF	BHF	133.00	163.00	1	120.0	5	7.01	214.0
SMCJ120A	SMCJ120CA	GHG	BHG	133.00	147.00	1	120.0	5	7.77	193.0
SMCJ130	SMCJ130C	GHH	BHH	144.00	176.00	1	130.0	5	6.49	231.0
SMCJ130A	SMCJ130CA	GHK	BHK	144.00	159.00	1	130.0	5	7.18	209.0
SMCJ140	SMCJ140C	GHA	BHA	155.68	190.40	1	140.0	5	5.99	250.6
SMCJ140A	SMCJ140CA	GHB	BHB	155.00	171.00	1	140.0	5	6.61	226.8
SMCJ150	SMCJ150C	GHL	BHL	167.00	204.00	1	150.0	5	5.60	268.0
SMCJ150A	SMCJ150CA	GHM	BHM	167.00	185.00	1	150.0	5	6.17	243.0
SMCJ160	SMCJ160C	GHN	BHN	178.00	218.00	1	160.0	5	5.23	287.0
SMCJ160A	SMCJ160CA	GHP	BHP	178.00	197.00	1	160.0	5	5.79	259.0

Transient Voltage Suppressors DO-214AB/SMC Package

SMCJ Series

MERITEK

ELECTRICAL CHARACTERISTICS(Continued)

Device Type (Uni)	Device Type (Bi)	Marking Code		Breakdown Voltage VBR@IT			Working Peak Reverse Voltage VRWM(V)	Maximum Reverse Leakage IR @ VRWM(V)	Maximum Reverse Surge Current Ipp(A)	Maximum Clamping Voltage VC@Ipp
		Uni	Bi	Min(V)	Max(V)	IT(mA)				
SMCJ170	SMCJ170C	GHQ	BHQ	189.00	231.00	1	170.0	5	4.93	304.0
SMCJ170A	SMCJ170CA	GHR	BHR	189.00	209.00	1	170.0	5	5.45	275.0
SMCJ180	SMCJ180C	GHS	BHS	200.16	244.80	1	180.0	5	4.66	322.2
SMCJ180A	SMCJ180CA	GHT	BHT	200.00	220.00	1	180.0	5	5.14	291.6
SMCJ190	SMCJ190C	GHU	BHU	211.28	258.40	1	190.0	5	4.41	340.1
SMCJ190A	SMCJ190CA	GHV	BHV	211.00	232.00	1	190.0	5	4.87	307.8
SMCJ200A	SMCJ200CA	GHW	BHW	224.00	247.00	1	200.0	5	4.60	324.0
SMCJ220A	SMCJ220CA	GHX	BHX	246.00	272.00	1	220.0	5	4.20	356.0
SMCJ250A	SMCJ250CA	GHZ	BHZ	279.00	309.00	1	250.0	5	3.70	405.0
SMCJ300A	SMCJ300CA	GJE	BJE	335.00	371.00	1	300.0	5	3.10	486.0
SMCJ350A	SMCJ350CA	GJG	BJG	391.00	432.00	1	350.0	5	2.60	567.0
SMCJ400A	SMCJ400CA	GJK	BJK	447.00	494.00	1	400.0	5	2.30	648.0
SMCJ440A	SMCJ440CA	GJM	BJM	492.00	543.00	1	440.0	5	2.10	713.0

CHARACTERISTICS CURVES

Fig.1 Pulse Derating Curve



Fig 2. Maximum Non-Repetitive Surge Current

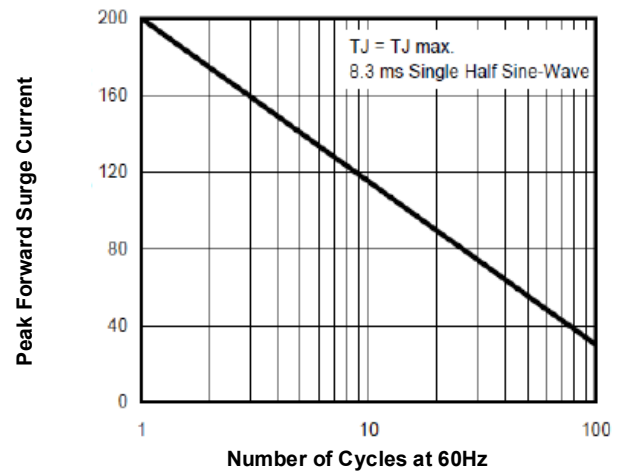

Fig 3. Steady State Power Derating Curve

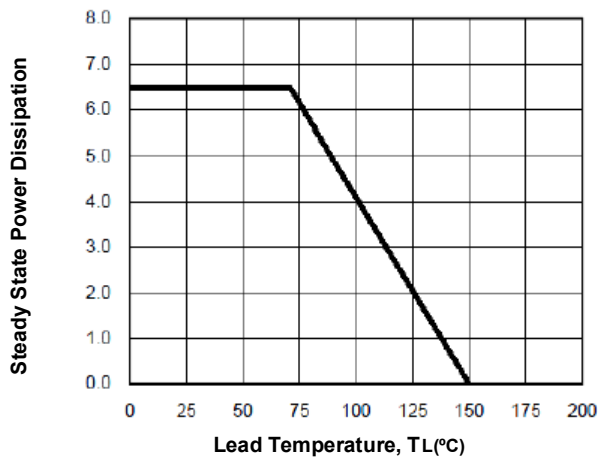

Fig 4. Peak Pulse Power Rating Curve



CHARACTERISTICS CURVES(Continued)

Fig 5. Pulse Waveform

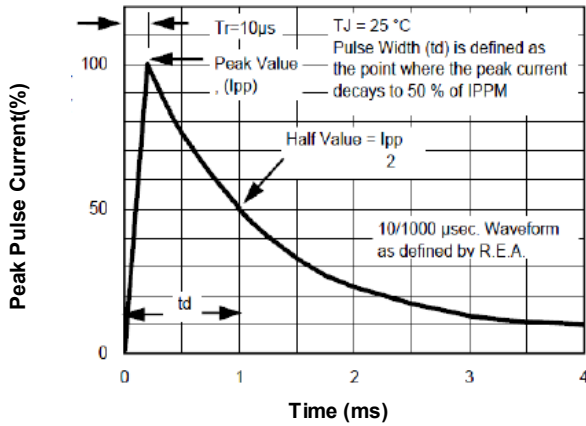
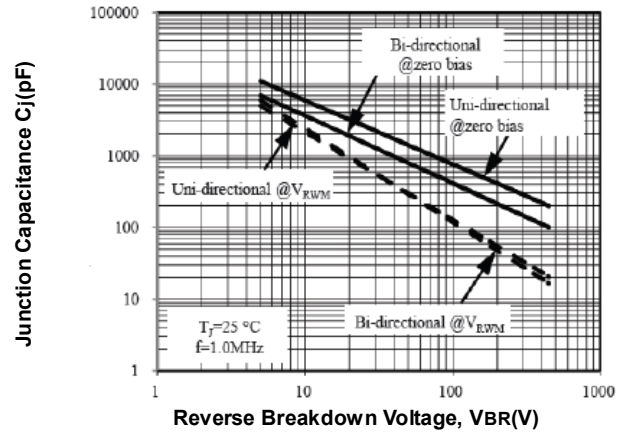
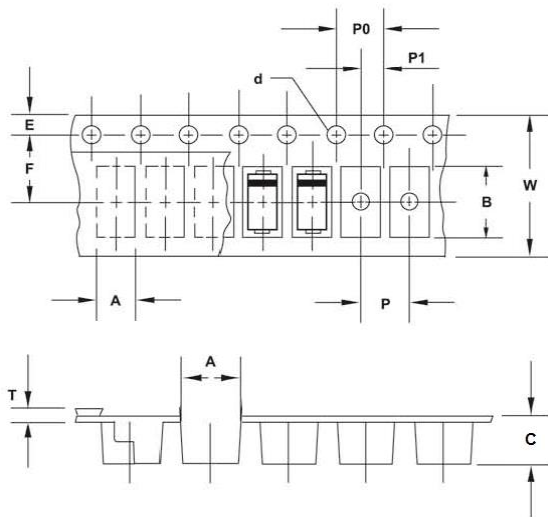

Fig 6. Typical Junction Capacitance



PACKAGING SPECIFICATION- DO214AB (SMC) - Tape Carrier and Reel



DO-214AB(SMC) - Tape carrier

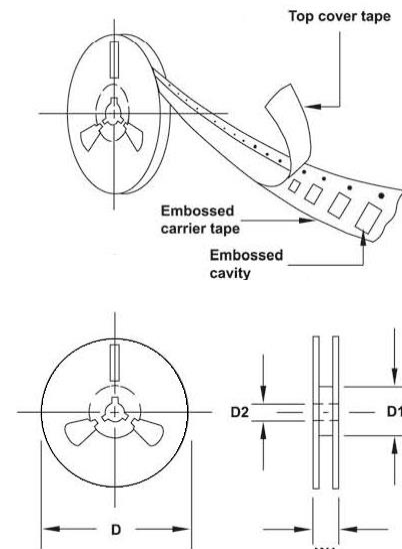

DO-214AB(SMC) - Reel

Item	Symbol	DO-214AB (SMC)	Item	Symbol	DO-214AB (SMC)
Carrier width	A	6.05 ± 0.10	Punch hole position	F	7.50 ± 0.10
Carrier length	B	8.31 ± 0.10	Punch hole pitch	P	8.00 ± 0.10
Carrier depth	C	2.54 ± 0.10	Sprocket hole pitch	P0	4.00 ± 0.10
Sprocket hole	d	1.55 ± 0.10	Embossment center	P1	2.00 ± 0.10
Reel outside diameter	D	330.0 ± 2.0	Overall tape thickness	T	Max 0.4
Reel inner diameter	D1	Min 50	Tape width	W	16.00 ± 0.30
Feed hole diameter	D2	13.00 ± 0.50	Reel width	W1	Max 22.40
Sprocket hole position	E	1.75 ± 0.10			

Unit: mm

Transient Voltage Suppressors DO-214AB/SMC Package

SMCJ Series

MERITEK

RECOMMENDED SOLDERING PROFILES

Reflow Condition		
Average Ramp-up Rate T_L to T_P		3°C/second max.
Pre Heat	Temp. Min $T_{s(min)}$	150°C
	Tempe. Max $T_{s(max)}$	200°C
	Time (min. to max.) (t_s)	60-120 seconds
Ramp-up Rate $T_{s(max)}$ to T_L		3°C/second max.
Reflow	Temp. (T_L)	217°C
	Time (t_L)	60-260 seconds
Peak Temperature (T_P)		255 ^{-0/+5} °C
Time within 5°C of actual peak Temperature (t_p)		10-30 seconds
Ramp-down Rate		6°C/second max.
Time 25°C to peak Temp. (T_P)		6 minutes max.



Looking for pricing, stock, or lifecycle information?

Click below to explore more details on WIN SOURCE:

 [View SMCJ15C on WIN SOURCE](#)

 [Meritek Information](#)

Optimize Your Supply Chain with WIN SOURCE Solutions

-  Global Sourcing Solution
-  Obsolete Management
-  Cost Control Management
-  Shortage Management
-  Alternative Solution
-  Excess Inventory Management