



**THE DATASHEET OF
SMDA03C-4/TR13**





8700 E. Thomas Road
 Scottsdale, AZ 85251
 Tel: (480) 941-6300
 Fax: (480) 947-1503

SMDA03C-4
 thru
SMDA24C-4

TVSarray[®] Series

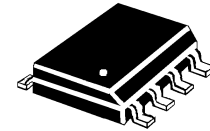

DESCRIPTION (300 watt)

This TRANSIENT VOLTAGE SUPPRESSOR (TVS) array is packaged in an SO-8 configuration giving protection to 4 Bidirectional data or interface lines. It is designed for use in applications where protection is required at the board level from voltage transients caused by electrostatic discharge (ESD) as defined in IEC 1000-4-2, electrical fast transients (EFT) per IEC 1000-4-4 and effects of secondary lighting.

These TVS arrays have a peak power rating of 300 watts for an 8/20 μ sec pulse. This array is suitable for protection of sensitive circuitry consisting of TTL, CMOS DRAM's, SRAM's, HCMOS, HSIC microprocessors, and I/O transceivers. The SMDAXXC-4 product provides board level protection from static electricity and other induced voltage surges that can damage sensitive circuitry.

FEATURES

- Protects up to 4 Bidirectional lines
- Surge protection Per IEC 1000-4-2, 1000-4-4
- SO-8 Packaging

MECHANICAL

- Molded SO-8 Surface Mount
- Weight: 0.066 grams (approximate)
- Marking: Logo, device number, date code
- Pin #1 defined by DOT on top of package

MAXIMUM RATINGS

- Operating Temperatures: -55^oC to +150^oC
- Storage Temperature: -55^oC to +150^oC
- Peak Pulse Power: 300 Watts (8/20 μ sec, Figure 1)
- Pulse Repetition Rate: <.01%

PACKAGING

- Tape & Reel EIA Standard 481-1-A
- 13 inch reel 2,500 (OPTIONAL)
- Carrier tubes 95 pcs per (STANDARD)

ELECTRICAL CHARACTERISTICS PER LINE @ 25^oC Unless otherwise specified

PART NUMBER	DEVICE MARKING	STAND OFF VOLTAGE V_{WM}	BREAKDOWN VOLTAGE V_{BR} @1 mA	CLAMPING VOLTAGE V_C @ 1 Amp (FIGURE 2)	CLAMPING VOLTAGE V_C @ 5 Amp (FIGURE 2)	LEAKAGE CURRENT I_b @ V_{WM}	CAPACITANCE (f=1 MHz) @0V C	TEMPERATURE COEFFICIENT OF V_{BR} $\frac{\Delta V_{BR}}{V_{BR}} \frac{\Delta T}{mV/^oC}$
		VOLTS	VOLTS	VOLTS	VOLTS	μ A	pF	
		MAX	MIN	MAX	MAX	MAX	TYP	MAX
SMDA03C-4	REA	3.3	4	7.0	9.0	200	300	-5
SMDA05C-4	REB	5.0	6.0	9.8	11	400	200	3
SMDA12C-4	REC	12.0	13.3	19.0	24	1	185	10
SMDA15C-4	RED	15.0	16.7	24.0	30	1	140	13
SMDA24C-4	REE	24.0	26.7	43.0	55	1	90	30

NOTE: TVS product is normally selected based on its stand off Voltage V_{WM} . Product selected voltage should be equal to or greater than the continuous peak operating voltage of the circuit to be protected.

Application: The SMDAXXC-4 product is designed for transient voltage suppression protection of ESD sensitive components at the board level. It is an ideal product to be used for protection of I/O Transceivers.

WAVE FORMS

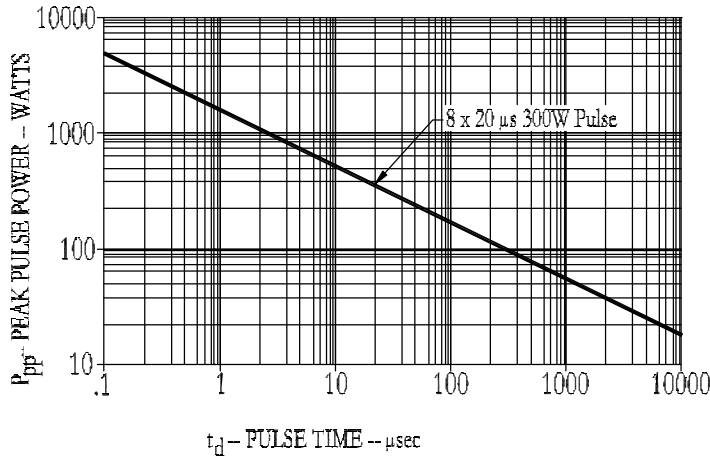

FIGURE 1
Peak Pulse Power Vs Pulse Time

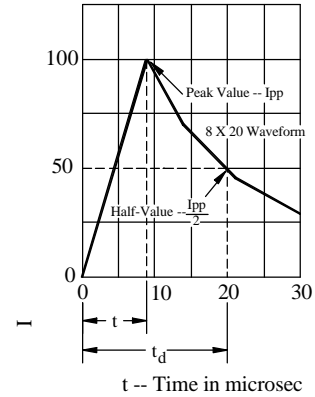
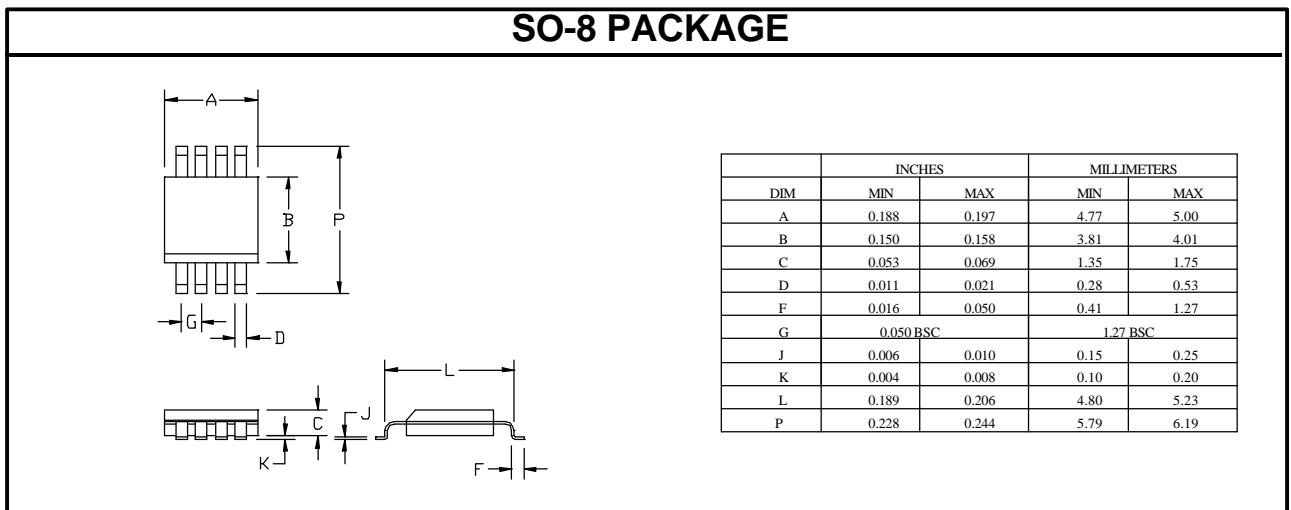
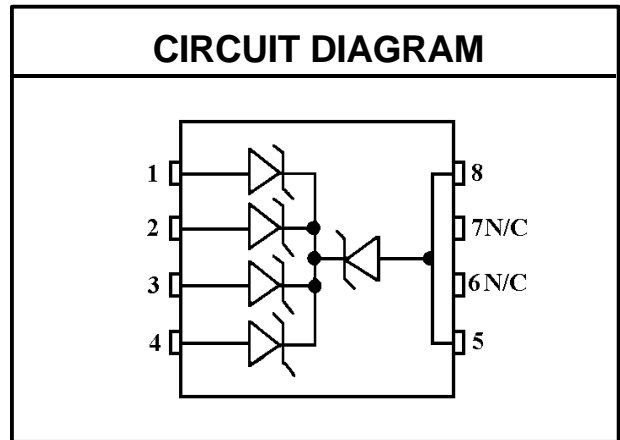
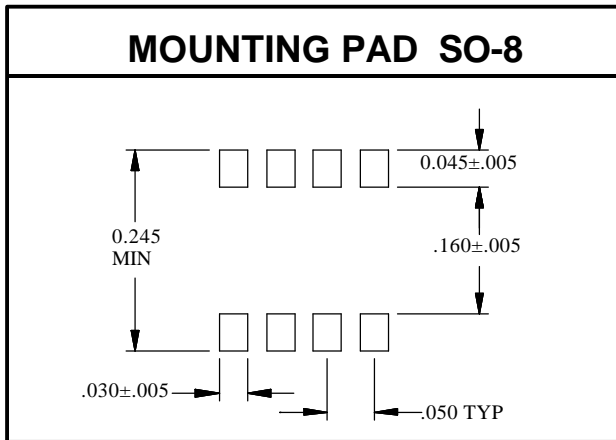



FIGURE 2
Pulse Wave Form



Looking for pricing, stock, or lifecycle information?

Click below to explore more details on WIN SOURCE:

-  [View SMDA03C-4/TR13 on WIN SOURCE](#)
-  [Microchip Technology](#) Information

Optimize Your Supply Chain with WIN SOURCE Solutions

-  Global Sourcing Solution
-  Obsolete Management
-  Cost Control Management
-  Shortage Management
-  Alternative Solution
-  Excess Inventory Management